







Assembly code	Assembly description	Assembly image
ASM1854A/0.D11	General overview	
ASM2923B/0.D04	Door	
ASM4042D/0.D12	Cooking chamber	
ASM4045C/0.D04	External cover	



ASM1854A/0.D11 - General overview - FRONT

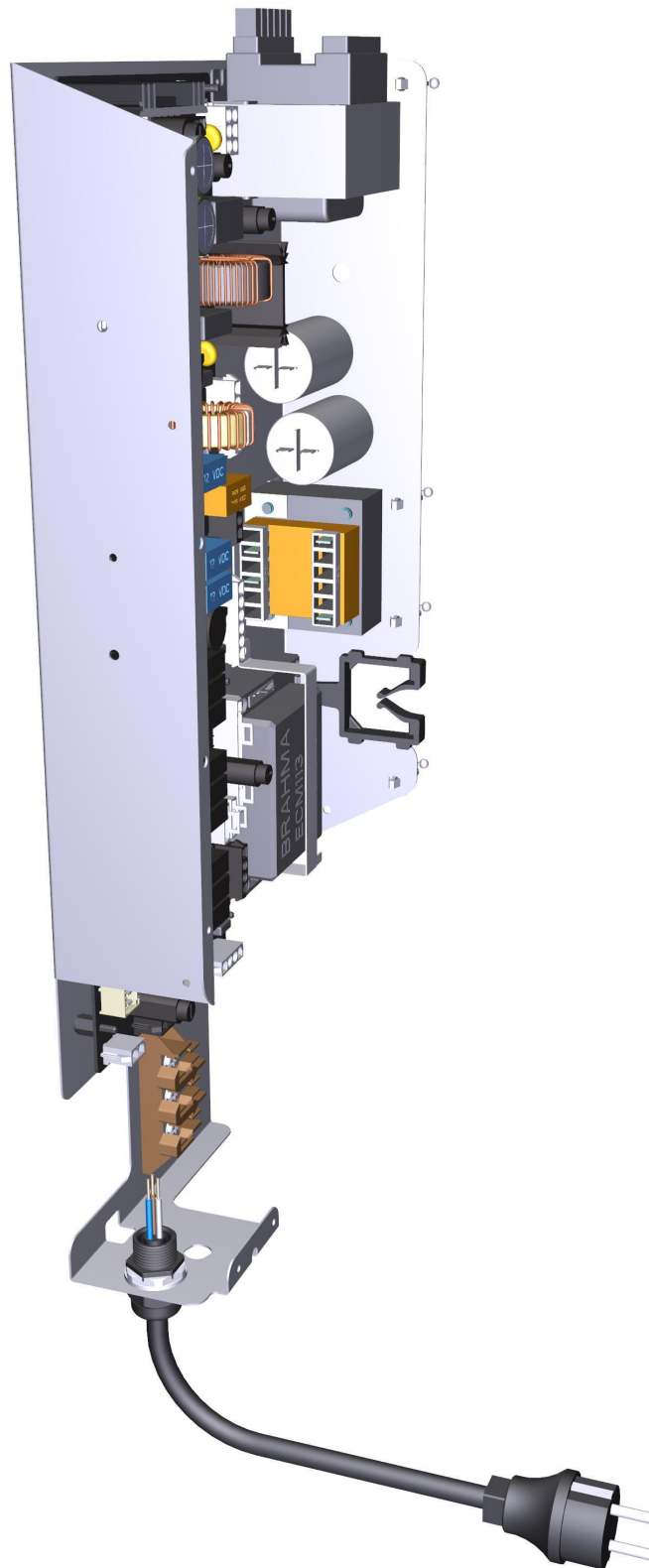

ASM1854A/0.D11 - General overview - REAR

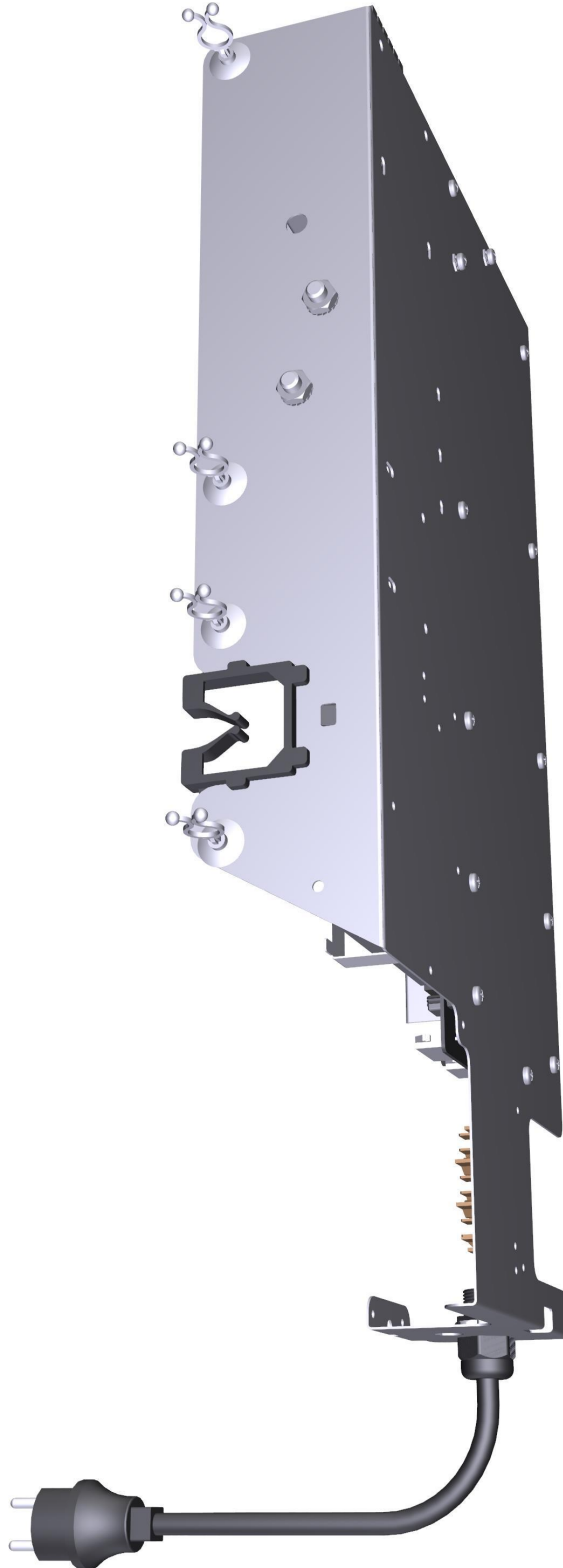





COMPONENT			SPARE PART																		
Code	Description	Image	Code	Description	Kit components																
0H7452A	0H7452A7		0H7452A2	XEVC GAS COMPONENTS HOLDER PROFILE																	
0H7462A	VE1636A GEARCASE STOPPING PLATE		0H7462A0	VE1636A GEARCASE STOPPING PLATE																	
PE2021C	MM EU GAS POWER BOARD		KPE2021C	MM GAS EU POWER BOARD KIT	<table border="1"> <thead> <tr> <th>Code</th> <th>Description</th> <th>Qty</th> <th>UOM</th> </tr> </thead> <tbody> <tr> <td>PE2021C0</td> <td>MM EU GAS POWER BOARD</td> <td>1.000</td> <td>PC</td> </tr> <tr> <td>VI1850A0</td> <td>TCB M4x6 SCREW</td> <td>12.000</td> <td>PC</td> </tr> <tr> <td>VM1745A0</td> <td>CARD SUPPORT</td> <td>12.000</td> <td>PC</td> </tr> </tbody> </table>	Code	Description	Qty	UOM	PE2021C0	MM EU GAS POWER BOARD	1.000	PC	VI1850A0	TCB M4x6 SCREW	12.000	PC	VM1745A0	CARD SUPPORT	12.000	PC
Code	Description	Qty	UOM																		
PE2021C0	MM EU GAS POWER BOARD	1.000	PC																		
VI1850A0	TCB M4x6 SCREW	12.000	PC																		
VM1745A0	CARD SUPPORT	12.000	PC																		
VM1745A	CARD SUPPORT		KVM1745A	BOARD SUPPORT 10 PCS KIT	<table border="1"> <thead> <tr> <th>Code</th> <th>Description</th> <th>Qty</th> <th>UOM</th> </tr> </thead> <tbody> <tr> <td>VM1745A0</td> <td>CARD SUPPORT</td> <td>10.000</td> <td>PC</td> </tr> </tbody> </table>	Code	Description	Qty	UOM	VM1745A0	CARD SUPPORT	10.000	PC								
Code	Description	Qty	UOM																		
VM1745A0	CARD SUPPORT	10.000	PC																		
CN1003A	6,3 uF MOTOR CAPACITOR		KCN1003A	6,3 uF MOTOR CAPACITOR KIT	<table border="1"> <thead> <tr> <th>Code</th> <th>Description</th> <th>Qty</th> <th>UOM</th> </tr> </thead> <tbody> <tr> <td>CN1003A0</td> <td>6,3 uF MOTOR CAPACITOR</td> <td>1.000</td> <td>PC</td> </tr> <tr> <td>VI1931A0</td> <td>M8x1.65 H4 CH13 ZINC PLATED NUT</td> <td>1.000</td> <td>PC</td> </tr> <tr> <td>VI1932A0</td> <td>D8 INDENTED ZINC PLATED WASHER</td> <td>1.000</td> <td>PC</td> </tr> </tbody> </table>	Code	Description	Qty	UOM	CN1003A0	6,3 uF MOTOR CAPACITOR	1.000	PC	VI1931A0	M8x1.65 H4 CH13 ZINC PLATED NUT	1.000	PC	VI1932A0	D8 INDENTED ZINC PLATED WASHER	1.000	PC
Code	Description	Qty	UOM																		
CN1003A0	6,3 uF MOTOR CAPACITOR	1.000	PC																		
VI1931A0	M8x1.65 H4 CH13 ZINC PLATED NUT	1.000	PC																		
VI1932A0	D8 INDENTED ZINC PLATED WASHER	1.000	PC																		



COMPONENT			SPARE PART														
Code	Description	Image	Code	Description	Kit components												
MR1025A	3 POLES 450V 41A+GROUND TERMINAL BLOCK		KMR1025A	3 POLES TERMINAL BLOCK KIT	<table border="1"> <thead> <tr> <th>Code</th> <th>Description</th> <th>Qty</th> <th>UOM</th> </tr> </thead> <tbody> <tr> <td>MR1025A1</td> <td>3 POLES 450V 41A+GROUND TERMINAL BLOCK</td> <td>1.000</td> <td>PC</td> </tr> </tbody> </table>	Code	Description	Qty	UOM	MR1025A1	3 POLES 450V 41A+GROUND TERMINAL BLOCK	1.000	PC				
Code	Description	Qty	UOM														
MR1025A1	3 POLES 450V 41A+GROUND TERMINAL BLOCK	1.000	PC														
VE1026A	230-21-12Vac 80VA TRANSFORMER		KVE1026A	230-21-12vac 90VA TRANSFORMER KIT	<table border="1"> <thead> <tr> <th>Code</th> <th>Description</th> <th>Qty</th> <th>UOM</th> </tr> </thead> <tbody> <tr> <td>VE1026A0</td> <td>230-21-12Vac 80VA TRANSFORME</td> <td>1.000</td> <td>PC</td> </tr> <tr> <td>VI1950A0</td> <td>ST. STEEL 4,2X13 TCB SELF-DRILLIN G SCREW</td> <td>4.000</td> <td>PC</td> </tr> </tbody> </table>	Code	Description	Qty	UOM	VE1026A0	230-21-12Vac 80VA TRANSFORME	1.000	PC	VI1950A0	ST. STEEL 4,2X13 TCB SELF-DRILLIN G SCREW	4.000	PC
Code	Description	Qty	UOM														
VE1026A0	230-21-12Vac 80VA TRANSFORME	1.000	PC														
VI1950A0	ST. STEEL 4,2X13 TCB SELF-DRILLIN G SCREW	4.000	PC														
VE1275A	STRAIN RELIEF PG 13.5		KVE1275A	PG 13.5 CABLE GLAND + NUT KIT	<table border="1"> <thead> <tr> <th>Code</th> <th>Description</th> <th>Qty</th> <th>UOM</th> </tr> </thead> <tbody> <tr> <td>VE1275A0</td> <td>STRAIN RELIEF PG 13.</td> <td>1.000</td> <td>PC</td> </tr> <tr> <td>VE1280A0</td> <td>NUT WITH COLLAR FOR STRAIN RELIEF PG13,5</td> <td>1.000</td> <td>PC</td> </tr> </tbody> </table>	Code	Description	Qty	UOM	VE1275A0	STRAIN RELIEF PG 13.	1.000	PC	VE1280A0	NUT WITH COLLAR FOR STRAIN RELIEF PG13,5	1.000	PC
Code	Description	Qty	UOM														
VE1275A0	STRAIN RELIEF PG 13.	1.000	PC														
VE1280A0	NUT WITH COLLAR FOR STRAIN RELIEF PG13,5	1.000	PC														
VE1280A	NUT WITH COLLAR FOR STRAIN RELIEF PG13,5		KVE1275A	PG 13.5 CABLE GLAND + NUT KIT	<table border="1"> <thead> <tr> <th>Code</th> <th>Description</th> <th>Qty</th> <th>UOM</th> </tr> </thead> <tbody> <tr> <td>VE1275A0</td> <td>STRAIN RELIEF PG 13.</td> <td>1.000</td> <td>PC</td> </tr> <tr> <td>VE1280A0</td> <td>NUT WITH COLLAR FOR STRAIN RELIEF PG13,5</td> <td>1.000</td> <td>PC</td> </tr> </tbody> </table>	Code	Description	Qty	UOM	VE1275A0	STRAIN RELIEF PG 13.	1.000	PC	VE1280A0	NUT WITH COLLAR FOR STRAIN RELIEF PG13,5	1.000	PC
Code	Description	Qty	UOM														
VE1275A0	STRAIN RELIEF PG 13.	1.000	PC														
VE1280A0	NUT WITH COLLAR FOR STRAIN RELIEF PG13,5	1.000	PC														
VE1636B	J1Y2F 250V MULTIFLAME IGNITION BOX		KVE1636B	240V 50/60HZ MULTIFLAME IGNITION BOX KIT	<table border="1"> <thead> <tr> <th>Code</th> <th>Description</th> <th>Qty</th> <th>UOM</th> </tr> </thead> <tbody> <tr> <td>CE1047A1</td> <td>FLAME DETECTOR CANDLE CABL</td> <td>1.000</td> <td>PC</td> </tr> <tr> <td>VE1636B0</td> <td>J1Y2F 250V MULTIFLAME IGNITION BOX</td> <td>1.000</td> <td>PC</td> </tr> </tbody> </table>	Code	Description	Qty	UOM	CE1047A1	FLAME DETECTOR CANDLE CABL	1.000	PC	VE1636B0	J1Y2F 250V MULTIFLAME IGNITION BOX	1.000	PC
Code	Description	Qty	UOM														
CE1047A1	FLAME DETECTOR CANDLE CABL	1.000	PC														
VE1636B0	J1Y2F 250V MULTIFLAME IGNITION BOX	1.000	PC														

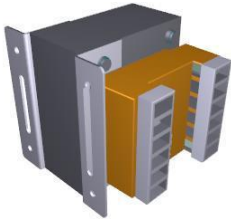

COMPONENT			SPARE PART																						
Code	Description	Image	Code	Description	Kit components																				
VE1648A	VE1648A0		KVE1648A	INSULATION TRANSF 230-220/40VA KIT	<table border="1"> <thead> <tr> <th>Code</th> <th>Description</th> <th>Qty</th> <th>UOM</th> </tr> </thead> <tbody> <tr> <td>0H1988A0</td> <td>GAS INSULATION TRANSFORME R SUPPORT</td> <td>1.000</td> <td>PC</td> </tr> <tr> <td>IE1648A0</td> <td></td> <td>1.000</td> <td>PC</td> </tr> <tr> <td>VE1648A0</td> <td>VE1648A0</td> <td>1.000</td> <td>PC</td> </tr> <tr> <td>VI1950A0</td> <td>ST. STEEL 4,2X13 TCB SELF-DRILLIN G SCREW</td> <td>2.000</td> <td>PC</td> </tr> </tbody> </table>	Code	Description	Qty	UOM	0H1988A0	GAS INSULATION TRANSFORME R SUPPORT	1.000	PC	IE1648A0		1.000	PC	VE1648A0	VE1648A0	1.000	PC	VI1950A0	ST. STEEL 4,2X13 TCB SELF-DRILLIN G SCREW	2.000	PC
Code	Description	Qty	UOM																						
0H1988A0	GAS INSULATION TRANSFORME R SUPPORT	1.000	PC																						
IE1648A0		1.000	PC																						
VE1648A0	VE1648A0	1.000	PC																						
VI1950A0	ST. STEEL 4,2X13 TCB SELF-DRILLIN G SCREW	2.000	PC																						
VM1188A	POWER BOARD WIRES PASS-THROUGH		KVM1188A	POWER BOARD WIRES PASS-THROUGH 10PCS KIT	<table border="1"> <thead> <tr> <th>Code</th> <th>Description</th> <th>Qty</th> <th>UOM</th> </tr> </thead> <tbody> <tr> <td>VM1188A0</td> <td>POWER BOARD WIRES PASS-THROU GH</td> <td>10.000</td> <td>PC</td> </tr> </tbody> </table>	Code	Description	Qty	UOM	VM1188A0	POWER BOARD WIRES PASS-THROU GH	10.000	PC												
Code	Description	Qty	UOM																						
VM1188A0	POWER BOARD WIRES PASS-THROU GH	10.000	PC																						

ASM2923B/0.D04 - Door - FRONT





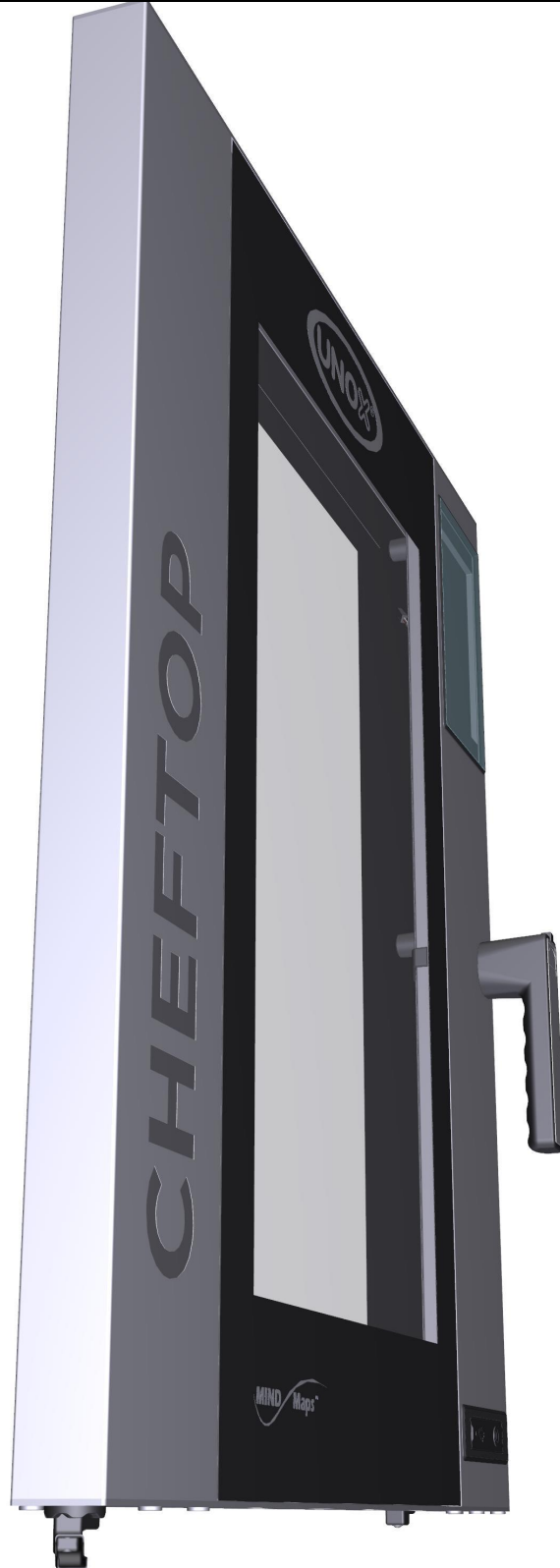

ASM2923B/0.D04 - Door - REAR





COMPONENT			SPARE PART																																																																						
Code	Description	Image	Code	Description	Kit components																																																																				
OB1116A	XEVC-1011-E LEFT EXT DOOR COLUMN		KDR1308A	1011 ZERO -M RIGHT COMPLETE DOOR KIT	<table border="1"> <thead> <tr> <th>Code</th> <th>Description</th> <th>Qty</th> <th>UOM</th> </tr> </thead> <tbody> <tr> <td>OB1116A0</td> <td>XEVC-1011-E LEFT EXT DOOR COLUMN</td> <td>1.000</td> <td>PC</td> </tr> <tr> <td>OB1117A2</td> <td>1011 RIGHT - DOOR LEFT INT COLUMN</td> <td>1.000</td> <td>PC</td> </tr> <tr> <td>OB1118B1</td> <td>XEVC-1011 DOOR RIGHT EXTERNAL COLUMN</td> <td>1.000</td> <td>PC</td> </tr> <tr> <td>OB1119A2</td> <td>1011 RIGHT - DOOR RIGHT INT COLUMN</td> <td>1.000</td> <td>PC</td> </tr> <tr> <td>OB1122B0</td> <td>MM CT 750mm DOOR LOWER BEAM</td> <td>1.000</td> <td>PC</td> </tr> <tr> <td>OB1168A1</td> <td>XEVC-1011-E EXT GLASS SUPPORT PROFILE</td> <td>2.000</td> <td>PC</td> </tr> <tr> <td>OB1216B0</td> <td>MM DOUBLE GLASS DOOR 750mm UPPER BEAM</td> <td>1.000</td> <td>PC</td> </tr> <tr> <td>OB1217A1</td> <td>MM DOUBLE GLASS DOOR INT UPPER BEAM 750</td> <td>1.000</td> <td>PC</td> </tr> <tr> <td>0H2892A0</td> <td>LED BAR UPPER CAP PLATE</td> <td>1.000</td> <td>PC</td> </tr> <tr> <td>0H2893A0</td> <td>LED BAR LOWER CAP PLATE</td> <td>1.000</td> <td>PC</td> </tr> <tr> <td>CE1097A0</td> <td>4M SIHF 4 POLES MICROFIT CANBUS</td> <td>1.000</td> <td>PC</td> </tr> <tr> <td>CE1285A0</td> <td>EMI ROUND FERRITE MOD.26438015 02</td> <td>2.000</td> <td>PC</td> </tr> <tr> <td>CE1851A0</td> <td>MICROFIT CABLE 2P M-F-F AWG22</td> <td>1.000</td> <td>PC</td> </tr> <tr> <td>CE2006A1</td> <td>MICROFIT CABLE 2PM-400-AMP MODU2 2PF</td> <td>1.000</td> <td>PC</td> </tr> <tr> <td>GN1525A0</td> <td>O-RING INT DIAM 9,5 THK 1 NBR 70</td> <td>1.000</td> <td>PC</td> </tr> <tr> <td>LP1056A0</td> <td>S6 L400 E750 LED BAR</td> <td>1.000</td> <td>PC</td> </tr> </tbody> </table>	Code	Description	Qty	UOM	OB1116A0	XEVC-1011-E LEFT EXT DOOR COLUMN	1.000	PC	OB1117A2	1011 RIGHT - DOOR LEFT INT COLUMN	1.000	PC	OB1118B1	XEVC-1011 DOOR RIGHT EXTERNAL COLUMN	1.000	PC	OB1119A2	1011 RIGHT - DOOR RIGHT INT COLUMN	1.000	PC	OB1122B0	MM CT 750mm DOOR LOWER BEAM	1.000	PC	OB1168A1	XEVC-1011-E EXT GLASS SUPPORT PROFILE	2.000	PC	OB1216B0	MM DOUBLE GLASS DOOR 750mm UPPER BEAM	1.000	PC	OB1217A1	MM DOUBLE GLASS DOOR INT UPPER BEAM 750	1.000	PC	0H2892A0	LED BAR UPPER CAP PLATE	1.000	PC	0H2893A0	LED BAR LOWER CAP PLATE	1.000	PC	CE1097A0	4M SIHF 4 POLES MICROFIT CANBUS	1.000	PC	CE1285A0	EMI ROUND FERRITE MOD.26438015 02	2.000	PC	CE1851A0	MICROFIT CABLE 2P M-F-F AWG22	1.000	PC	CE2006A1	MICROFIT CABLE 2PM-400-AMP MODU2 2PF	1.000	PC	GN1525A0	O-RING INT DIAM 9,5 THK 1 NBR 70	1.000	PC	LP1056A0	S6 L400 E750 LED BAR	1.000	PC
Code	Description	Qty	UOM																																																																						
OB1116A0	XEVC-1011-E LEFT EXT DOOR COLUMN	1.000	PC																																																																						
OB1117A2	1011 RIGHT - DOOR LEFT INT COLUMN	1.000	PC																																																																						
OB1118B1	XEVC-1011 DOOR RIGHT EXTERNAL COLUMN	1.000	PC																																																																						
OB1119A2	1011 RIGHT - DOOR RIGHT INT COLUMN	1.000	PC																																																																						
OB1122B0	MM CT 750mm DOOR LOWER BEAM	1.000	PC																																																																						
OB1168A1	XEVC-1011-E EXT GLASS SUPPORT PROFILE	2.000	PC																																																																						
OB1216B0	MM DOUBLE GLASS DOOR 750mm UPPER BEAM	1.000	PC																																																																						
OB1217A1	MM DOUBLE GLASS DOOR INT UPPER BEAM 750	1.000	PC																																																																						
0H2892A0	LED BAR UPPER CAP PLATE	1.000	PC																																																																						
0H2893A0	LED BAR LOWER CAP PLATE	1.000	PC																																																																						
CE1097A0	4M SIHF 4 POLES MICROFIT CANBUS	1.000	PC																																																																						
CE1285A0	EMI ROUND FERRITE MOD.26438015 02	2.000	PC																																																																						
CE1851A0	MICROFIT CABLE 2P M-F-F AWG22	1.000	PC																																																																						
CE2006A1	MICROFIT CABLE 2PM-400-AMP MODU2 2PF	1.000	PC																																																																						
GN1525A0	O-RING INT DIAM 9,5 THK 1 NBR 70	1.000	PC																																																																						
LP1056A0	S6 L400 E750 LED BAR	1.000	PC																																																																						



COMPONENT			SPARE PART					
Code	Description	Image	Code	Description	Kit components			
OB1116A	XEVC-1011-E LEFT EXT DOOR COLUMN		KDR1308A	1011 ZERO -M RIGHT COMPLETE DOOR KIT	Code	Description	Qty	UOM
					MG1099A1	MM COMPLETE HANDLE	1.000	PC
					SL1170A1	S57 BLACK SILICON - 310ml CARTRIDGE	43.000	ML
					SL1221A0	GN1/1 EXTERNAL GLASS UPPER SILICONE	1.000	PC
					SL1226A0	1011 EXTERNAL GLASS LATERAL SILICONE	4.000	PC
					VE1030A1	MAGNET FOR DOOR MICROSWITC H D=22.9mm	1.000	PC
					VI1034A0	STAINLESS STEEL WASHER 8.4x16x1	1.000	PC
					VI1074A0	4X16 SCREW FOR PLASTIC	4.000	PC
					VI1174A0		16.000	PC
					VI1220A1	4,2x12 TCB SELF-TAPPIN G SCREW	30.000	PC
					VI1565A0	WASHER INTD=4.2 EXTD=20 TH=125/10 INO	1.000	PC
					VI1996A0	M5x35 SCREW	13.000	PC
					VM1490A0	CHEFTOP/BAK ERTOP HANDLE SCREWS COVER	2.000	PC
					VM1630A1	INTERNAL GLASS PUSHING CAP	5.000	PC
					VM1631A0	PLUS INNER GLASS PUSHING CAP	5.000	PC
					VM2259B0	VM2259B0	1.000	PC
					VM2268A0	DOOR MAGNET COVER	1.000	PC
					VM2274A0	GROOVED BUSHING	1.000	PC
					VM2275A0	SMOOTH BUSHING	1.000	PC



COMPONENT			SPARE PART																																																																																	
Code	Description	Image	Code	Description	Kit components																																																																															
OB1116A	XEVC-1011-E LEFT EXT DOOR COLUMN		KDR1308A	1011 ZERO -M RIGHT COMPLETE DOOR KIT	<table border="1"> <thead> <tr> <th>Code</th> <th>Description</th> <th>Qty</th> <th>UOM</th> </tr> </thead> <tbody> <tr> <td>VM2284B0</td> <td>750 SERIES DRIP PROFILE KIT</td> <td>1.000</td> <td>PC</td> </tr> <tr> <td>VM2305A0</td> <td>MM SERIES DOOR CAP FIXING PAWL</td> <td>14.000</td> <td>PC</td> </tr> <tr> <td>VM2312A0</td> <td>MM DRIP PROFILE DRAIN LEFT PIPE</td> <td>1.000</td> <td>PC</td> </tr> <tr> <td>VM2314A0</td> <td>MM DRIP PROFILE CAP</td> <td>1.000</td> <td>PC</td> </tr> <tr> <td>VM2315B0</td> <td>MM - M INNER GLASS PUSHING CAP HOLDER</td> <td>5.000</td> <td>PC</td> </tr> <tr> <td>VM2410A0</td> <td>PLATE TO STOP EXTRUDED LED BAR</td> <td>1.000</td> <td>PC</td> </tr> <tr> <td>VM2505B1</td> <td>MM PLUS INTERNAL GLASS SUPPORT</td> <td>5.000</td> <td>PC</td> </tr> <tr> <td>VM2956A0</td> <td></td> <td>1.000</td> <td>PC</td> </tr> <tr> <td>VM2957A0</td> <td></td> <td>1.000</td> <td>PC</td> </tr> <tr> <td>VM2958A0</td> <td>MM - M DOOR LEFT UPPPER CAP ASSEMBL</td> <td>1.000</td> <td>PC</td> </tr> <tr> <td>VP1080A0</td> <td>UPPER HINGE CAP FOR LOWER INNER GLASS</td> <td>1.000</td> <td>PC</td> </tr> <tr> <td>VT1278A0</td> <td>EXTERNAL GLASS SER . XEVC-1011-E</td> <td>1.000</td> <td>PC</td> </tr> </tbody> </table>	Code	Description	Qty	UOM	VM2284B0	750 SERIES DRIP PROFILE KIT	1.000	PC	VM2305A0	MM SERIES DOOR CAP FIXING PAWL	14.000	PC	VM2312A0	MM DRIP PROFILE DRAIN LEFT PIPE	1.000	PC	VM2314A0	MM DRIP PROFILE CAP	1.000	PC	VM2315B0	MM - M INNER GLASS PUSHING CAP HOLDER	5.000	PC	VM2410A0	PLATE TO STOP EXTRUDED LED BAR	1.000	PC	VM2505B1	MM PLUS INTERNAL GLASS SUPPORT	5.000	PC	VM2956A0		1.000	PC	VM2957A0		1.000	PC	VM2958A0	MM - M DOOR LEFT UPPPER CAP ASSEMBL	1.000	PC	VP1080A0	UPPER HINGE CAP FOR LOWER INNER GLASS	1.000	PC	VT1278A0	EXTERNAL GLASS SER . XEVC-1011-E	1.000	PC	KDR1263B	1011 -M RIGHT EXTERNAL DOOR	<table border="1"> <thead> <tr> <th>Code</th> <th>Description</th> <th>Qty</th> <th>UOM</th> </tr> </thead> <tbody> <tr> <td>OB1116A0</td> <td>XEVC-1011-E LEFT EXT DOOR COLUMN</td> <td>1.000</td> <td>PC</td> </tr> <tr> <td>OB1117A2</td> <td>1011 RIGHT - DOOR LEFT INT COLUMN</td> <td>1.000</td> <td>PC</td> </tr> <tr> <td>OB1118B1</td> <td>XEVC-1011 DOOR RIGHT EXTERNAL COLUMN</td> <td>1.000</td> <td>PC</td> </tr> <tr> <td>OB1119A2</td> <td>1011 RIGHT - DOOR RIGHT INT COLUMN</td> <td>1.000</td> <td>PC</td> </tr> <tr> <td>OB1122B0</td> <td>MM CT 750mm DOOR LOWER BEAM</td> <td>1.000</td> <td>PC</td> </tr> </tbody> </table>	Code	Description	Qty	UOM	OB1116A0	XEVC-1011-E LEFT EXT DOOR COLUMN	1.000	PC	OB1117A2	1011 RIGHT - DOOR LEFT INT COLUMN	1.000	PC	OB1118B1	XEVC-1011 DOOR RIGHT EXTERNAL COLUMN	1.000	PC	OB1119A2	1011 RIGHT - DOOR RIGHT INT COLUMN	1.000	PC	OB1122B0	MM CT 750mm DOOR LOWER BEAM	1.000	PC
			Code	Description	Qty	UOM																																																																														
VM2284B0	750 SERIES DRIP PROFILE KIT	1.000	PC																																																																																	
VM2305A0	MM SERIES DOOR CAP FIXING PAWL	14.000	PC																																																																																	
VM2312A0	MM DRIP PROFILE DRAIN LEFT PIPE	1.000	PC																																																																																	
VM2314A0	MM DRIP PROFILE CAP	1.000	PC																																																																																	
VM2315B0	MM - M INNER GLASS PUSHING CAP HOLDER	5.000	PC																																																																																	
VM2410A0	PLATE TO STOP EXTRUDED LED BAR	1.000	PC																																																																																	
VM2505B1	MM PLUS INTERNAL GLASS SUPPORT	5.000	PC																																																																																	
VM2956A0		1.000	PC																																																																																	
VM2957A0		1.000	PC																																																																																	
VM2958A0	MM - M DOOR LEFT UPPPER CAP ASSEMBL	1.000	PC																																																																																	
VP1080A0	UPPER HINGE CAP FOR LOWER INNER GLASS	1.000	PC																																																																																	
VT1278A0	EXTERNAL GLASS SER . XEVC-1011-E	1.000	PC																																																																																	
Code	Description	Qty	UOM																																																																																	
OB1116A0	XEVC-1011-E LEFT EXT DOOR COLUMN	1.000	PC																																																																																	
OB1117A2	1011 RIGHT - DOOR LEFT INT COLUMN	1.000	PC																																																																																	
OB1118B1	XEVC-1011 DOOR RIGHT EXTERNAL COLUMN	1.000	PC																																																																																	
OB1119A2	1011 RIGHT - DOOR RIGHT INT COLUMN	1.000	PC																																																																																	
OB1122B0	MM CT 750mm DOOR LOWER BEAM	1.000	PC																																																																																	



COMPONENT			SPARE PART																																																														
Code	Description	Image	Code	Description	Kit components																																																												
0B1116A	XEVC-1011-E LEFT EXT DOOR COLUMN		KDR1263B	1011 -M RIGHT EXTERNAL DOOR	<table border="1"> <thead> <tr> <th>Code</th> <th>Description</th> <th>Qty</th> <th>UOM</th> </tr> </thead> <tbody> <tr> <td>0B1168A1</td> <td>XEVC-1011-E EXT GLASS SUPPORT PROFILE</td> <td>2.000</td> <td>PC</td> </tr> <tr> <td>0B1216B0</td> <td>MM DOUBLE GLASS DOOR 750mm UPPER BEAM</td> <td>1.000</td> <td>PC</td> </tr> <tr> <td>0B1217A1</td> <td>MM DOUBLE GLASS DOOR INT UPPER BEAM 750</td> <td>1.000</td> <td>PC</td> </tr> <tr> <td>CE1052A1</td> <td>MM USB-CONTRO L PANEL CONNECTING CABLE</td> <td>1.000</td> <td>PC</td> </tr> <tr> <td>CE1053B0</td> <td>MM MICROFIT LED BAR POWER SUPPLY CABL</td> <td>1.000</td> <td>PC</td> </tr> <tr> <td>CE1097A0</td> <td>4M SIHF 4 POLES MICROFIT CANBUS</td> <td>1.000</td> <td>PC</td> </tr> <tr> <td>CE1285A0</td> <td>EMI ROUND FERRITE MOD.26438015 02</td> <td>2.000</td> <td>PC</td> </tr> <tr> <td>GN1525A0</td> <td>O-RING INT DIAM 9,5 THK 1 NBR 70</td> <td>1.000</td> <td>PC</td> </tr> <tr> <td>LP1021A0</td> <td>6 SERIES L600 LED LIGHT BAR - E750</td> <td>1.000</td> <td>PC</td> </tr> <tr> <td>LP1027A0</td> <td>L750 MM NO LED LIGHT BAR COVER</td> <td>1.000</td> <td>PC</td> </tr> <tr> <td>MG1099A1</td> <td>MM COMPLETE HANDLE</td> <td>1.000</td> <td>PC</td> </tr> <tr> <td>SL1170A1</td> <td>S57 BLACK SILICON - 310ml CARTRIDGE</td> <td>43.000</td> <td>ML</td> </tr> <tr> <td>SL1221A0</td> <td>GN1/1 EXTERNAL GLASS UPPER SILICONE</td> <td>1.000</td> <td>PC</td> </tr> <tr> <td>SL1226A0</td> <td>1011 EXTERNAL GLASS LATERAL SILICONE</td> <td>4.000</td> <td>PC</td> </tr> </tbody> </table>	Code	Description	Qty	UOM	0B1168A1	XEVC-1011-E EXT GLASS SUPPORT PROFILE	2.000	PC	0B1216B0	MM DOUBLE GLASS DOOR 750mm UPPER BEAM	1.000	PC	0B1217A1	MM DOUBLE GLASS DOOR INT UPPER BEAM 750	1.000	PC	CE1052A1	MM USB-CONTRO L PANEL CONNECTING CABLE	1.000	PC	CE1053B0	MM MICROFIT LED BAR POWER SUPPLY CABL	1.000	PC	CE1097A0	4M SIHF 4 POLES MICROFIT CANBUS	1.000	PC	CE1285A0	EMI ROUND FERRITE MOD.26438015 02	2.000	PC	GN1525A0	O-RING INT DIAM 9,5 THK 1 NBR 70	1.000	PC	LP1021A0	6 SERIES L600 LED LIGHT BAR - E750	1.000	PC	LP1027A0	L750 MM NO LED LIGHT BAR COVER	1.000	PC	MG1099A1	MM COMPLETE HANDLE	1.000	PC	SL1170A1	S57 BLACK SILICON - 310ml CARTRIDGE	43.000	ML	SL1221A0	GN1/1 EXTERNAL GLASS UPPER SILICONE	1.000	PC	SL1226A0	1011 EXTERNAL GLASS LATERAL SILICONE	4.000	PC
					Code	Description	Qty	UOM																																																									
					0B1168A1	XEVC-1011-E EXT GLASS SUPPORT PROFILE	2.000	PC																																																									
					0B1216B0	MM DOUBLE GLASS DOOR 750mm UPPER BEAM	1.000	PC																																																									
					0B1217A1	MM DOUBLE GLASS DOOR INT UPPER BEAM 750	1.000	PC																																																									
					CE1052A1	MM USB-CONTRO L PANEL CONNECTING CABLE	1.000	PC																																																									
					CE1053B0	MM MICROFIT LED BAR POWER SUPPLY CABL	1.000	PC																																																									
					CE1097A0	4M SIHF 4 POLES MICROFIT CANBUS	1.000	PC																																																									
					CE1285A0	EMI ROUND FERRITE MOD.26438015 02	2.000	PC																																																									
					GN1525A0	O-RING INT DIAM 9,5 THK 1 NBR 70	1.000	PC																																																									
					LP1021A0	6 SERIES L600 LED LIGHT BAR - E750	1.000	PC																																																									
					LP1027A0	L750 MM NO LED LIGHT BAR COVER	1.000	PC																																																									
					MG1099A1	MM COMPLETE HANDLE	1.000	PC																																																									
					SL1170A1	S57 BLACK SILICON - 310ml CARTRIDGE	43.000	ML																																																									
					SL1221A0	GN1/1 EXTERNAL GLASS UPPER SILICONE	1.000	PC																																																									
SL1226A0	1011 EXTERNAL GLASS LATERAL SILICONE	4.000	PC																																																														



COMPONENT			SPARE PART																																																																																		
Code	Description	Image	Code	Description	Kit components																																																																																
OB1116A	XEVC-1011-E LEFT EXT DOOR COLUMN		KDR1263B	1011 -M RIGHT EXTERNAL DOOR	<table border="1"> <thead> <tr> <th>Code</th> <th>Description</th> <th>Qty</th> <th>UOM</th> </tr> </thead> <tbody> <tr> <td>VE1030A1</td> <td>MAGNET FOR DOOR MICROSWITC H D=22.9mm</td> <td>1.000</td> <td>PC</td> </tr> <tr> <td>VI1034A0</td> <td>STAINLESS STEEL WASHER 8.4x16x1</td> <td>1.000</td> <td>PC</td> </tr> <tr> <td>VI1074A0</td> <td>4X16 SCREW FOR PLASTIC</td> <td>4.000</td> <td>PC</td> </tr> <tr> <td>VI1174A0</td> <td></td> <td>16.000</td> <td>PC</td> </tr> <tr> <td>VI1220A1</td> <td>4,2x12 TCB SELF-TAPPIN G SCREW</td> <td>30.000</td> <td>PC</td> </tr> <tr> <td>VI1996A0</td> <td>M5x35 SCREW</td> <td>13.000</td> <td>PC</td> </tr> <tr> <td>VM1490A0</td> <td>CHEFTOP/BAK ERTOP HANDLE SCREWS COVER</td> <td>2.000</td> <td>PC</td> </tr> <tr> <td>VM1630A1</td> <td>INTERNAL GLASS PUSHING CAP</td> <td>5.000</td> <td>PC</td> </tr> <tr> <td>VM1631A0</td> <td>PLUS INNER GLASS PUSHING CAP</td> <td>5.000</td> <td>PC</td> </tr> <tr> <td>VM2259B0</td> <td>VM2259B0</td> <td>1.000</td> <td>PC</td> </tr> <tr> <td>VM2268A0</td> <td>DOOR MAGNET COVER</td> <td>1.000</td> <td>PC</td> </tr> <tr> <td>VM2274A0</td> <td>GROOVED BUSHING</td> <td>1.000</td> <td>PC</td> </tr> <tr> <td>VM2275A0</td> <td>SMOOTH BUSHING</td> <td>1.000</td> <td>PC</td> </tr> <tr> <td>VM2284B0</td> <td>750 SERIES DRIP PROFILE KIT</td> <td>1.000</td> <td>PC</td> </tr> <tr> <td>VM2305A0</td> <td>MM SERIES DOOR CAP FIXING PAWL</td> <td>14.000</td> <td>PC</td> </tr> <tr> <td>VM2312A0</td> <td>MM DRIP PROFILE DRAIN LEFT PIPE</td> <td>1.000</td> <td>PC</td> </tr> <tr> <td>VM2314A0</td> <td>MM DRIP PROFILE CAP</td> <td>1.000</td> <td>PC</td> </tr> <tr> <td>VM2315B0</td> <td>MM - M INNER GLASS PUSHING CAP HOLDER</td> <td>5.000</td> <td>PC</td> </tr> <tr> <td>VM2410A0</td> <td>PLATE TO STOP EXTRUDED LED BAR</td> <td>2.000</td> <td>PC</td> </tr> </tbody> </table>	Code	Description	Qty	UOM	VE1030A1	MAGNET FOR DOOR MICROSWITC H D=22.9mm	1.000	PC	VI1034A0	STAINLESS STEEL WASHER 8.4x16x1	1.000	PC	VI1074A0	4X16 SCREW FOR PLASTIC	4.000	PC	VI1174A0		16.000	PC	VI1220A1	4,2x12 TCB SELF-TAPPIN G SCREW	30.000	PC	VI1996A0	M5x35 SCREW	13.000	PC	VM1490A0	CHEFTOP/BAK ERTOP HANDLE SCREWS COVER	2.000	PC	VM1630A1	INTERNAL GLASS PUSHING CAP	5.000	PC	VM1631A0	PLUS INNER GLASS PUSHING CAP	5.000	PC	VM2259B0	VM2259B0	1.000	PC	VM2268A0	DOOR MAGNET COVER	1.000	PC	VM2274A0	GROOVED BUSHING	1.000	PC	VM2275A0	SMOOTH BUSHING	1.000	PC	VM2284B0	750 SERIES DRIP PROFILE KIT	1.000	PC	VM2305A0	MM SERIES DOOR CAP FIXING PAWL	14.000	PC	VM2312A0	MM DRIP PROFILE DRAIN LEFT PIPE	1.000	PC	VM2314A0	MM DRIP PROFILE CAP	1.000	PC	VM2315B0	MM - M INNER GLASS PUSHING CAP HOLDER	5.000	PC	VM2410A0	PLATE TO STOP EXTRUDED LED BAR	2.000	PC
Code	Description	Qty	UOM																																																																																		
VE1030A1	MAGNET FOR DOOR MICROSWITC H D=22.9mm	1.000	PC																																																																																		
VI1034A0	STAINLESS STEEL WASHER 8.4x16x1	1.000	PC																																																																																		
VI1074A0	4X16 SCREW FOR PLASTIC	4.000	PC																																																																																		
VI1174A0		16.000	PC																																																																																		
VI1220A1	4,2x12 TCB SELF-TAPPIN G SCREW	30.000	PC																																																																																		
VI1996A0	M5x35 SCREW	13.000	PC																																																																																		
VM1490A0	CHEFTOP/BAK ERTOP HANDLE SCREWS COVER	2.000	PC																																																																																		
VM1630A1	INTERNAL GLASS PUSHING CAP	5.000	PC																																																																																		
VM1631A0	PLUS INNER GLASS PUSHING CAP	5.000	PC																																																																																		
VM2259B0	VM2259B0	1.000	PC																																																																																		
VM2268A0	DOOR MAGNET COVER	1.000	PC																																																																																		
VM2274A0	GROOVED BUSHING	1.000	PC																																																																																		
VM2275A0	SMOOTH BUSHING	1.000	PC																																																																																		
VM2284B0	750 SERIES DRIP PROFILE KIT	1.000	PC																																																																																		
VM2305A0	MM SERIES DOOR CAP FIXING PAWL	14.000	PC																																																																																		
VM2312A0	MM DRIP PROFILE DRAIN LEFT PIPE	1.000	PC																																																																																		
VM2314A0	MM DRIP PROFILE CAP	1.000	PC																																																																																		
VM2315B0	MM - M INNER GLASS PUSHING CAP HOLDER	5.000	PC																																																																																		
VM2410A0	PLATE TO STOP EXTRUDED LED BAR	2.000	PC																																																																																		



COMPONENT			SPARE PART																																											
Code	Description	Image	Code	Description	Kit components																																									
0B1116A	XEVC-1011-E LEFT EXT DOOR COLUMN		KDR1263B	1011 -M RIGHT EXTERNAL DOOR	<table border="1"> <thead> <tr> <th>Code</th> <th>Description</th> <th>Qty</th> <th>UOM</th> </tr> </thead> <tbody> <tr> <td>VM2505B1</td> <td>MM PLUS INTERNAL GLASS SUPPORT</td> <td>5.000</td> <td>PC</td> </tr> <tr> <td>VM3008A0</td> <td></td> <td>1.000</td> <td>PC</td> </tr> <tr> <td>VM3010A0</td> <td></td> <td>1.000</td> <td>PC</td> </tr> <tr> <td>VM3011A0</td> <td></td> <td>1.000</td> <td>PC</td> </tr> <tr> <td>VP1080A0</td> <td>UPPER HINGE CAP FOR LOWER INNER GLASS</td> <td>1.000</td> <td>PC</td> </tr> <tr> <td>VT1278A0</td> <td>EXTERNAL GLASS SER. XEVC-1011-E</td> <td>1.000</td> <td>PC</td> </tr> </tbody> </table>	Code	Description	Qty	UOM	VM2505B1	MM PLUS INTERNAL GLASS SUPPORT	5.000	PC	VM3008A0		1.000	PC	VM3010A0		1.000	PC	VM3011A0		1.000	PC	VP1080A0	UPPER HINGE CAP FOR LOWER INNER GLASS	1.000	PC	VT1278A0	EXTERNAL GLASS SER. XEVC-1011-E	1.000	PC													
			Code	Description	Qty	UOM																																								
VM2505B1	MM PLUS INTERNAL GLASS SUPPORT	5.000	PC																																											
VM3008A0		1.000	PC																																											
VM3010A0		1.000	PC																																											
VM3011A0		1.000	PC																																											
VP1080A0	UPPER HINGE CAP FOR LOWER INNER GLASS	1.000	PC																																											
VT1278A0	EXTERNAL GLASS SER. XEVC-1011-E	1.000	PC																																											
KDR1263A	1011 RIGHT EXTERNAL DOOR KI	<table border="1"> <thead> <tr> <th>Code</th> <th>Description</th> <th>Qty</th> <th>UOM</th> </tr> </thead> <tbody> <tr> <td>0B1116A0</td> <td>XEVC-1011-E LEFT EXT DOOR COLUM</td> <td>1.000</td> <td>PC</td> </tr> <tr> <td>0B1117A2</td> <td>1011 RIGHT - DOOR LEFT INT COLUMN</td> <td>1.000</td> <td>PC</td> </tr> <tr> <td>0B1118B1</td> <td>XEVC-1011 DOOR RIGHT EXTERNAL COLUMN</td> <td>1.000</td> <td>PC</td> </tr> <tr> <td>0B1119A2</td> <td>1011 RIGHT - DOOR RIGHT INT COLUMN</td> <td>1.000</td> <td>PC</td> </tr> <tr> <td>0B1122A1</td> <td>750MM DOOR LOWER FRAME SHAPE</td> <td>1.000</td> <td>PC</td> </tr> <tr> <td>0B1168A1</td> <td>XEVC-1011-E EXT GLASS SUPPORT PROFILE</td> <td>2.000</td> <td>PC</td> </tr> <tr> <td>0B1216A1</td> <td>MM CT DOUBLE GLASS DOOR UPPER BEAM</td> <td>1.000</td> <td>PC</td> </tr> <tr> <td>0B1217A1</td> <td>MM DOUBLE GLASS DOOR INT UPPER BEAM 750</td> <td>1.000</td> <td>PC</td> </tr> <tr> <td>CE1052A1</td> <td>MM USB-CONTRO L PANEL CONNECTING CABLE</td> <td>1.000</td> <td>PC</td> </tr> <tr> <td>CE1053B0</td> <td>MM MICROFIT LED BAR POWER SUPPLY CABL</td> <td>1.000</td> <td>PC</td> </tr> </tbody> </table>	Code	Description	Qty	UOM	0B1116A0	XEVC-1011-E LEFT EXT DOOR COLUM	1.000	PC	0B1117A2	1011 RIGHT - DOOR LEFT INT COLUMN	1.000	PC	0B1118B1	XEVC-1011 DOOR RIGHT EXTERNAL COLUMN	1.000	PC	0B1119A2	1011 RIGHT - DOOR RIGHT INT COLUMN	1.000	PC	0B1122A1	750MM DOOR LOWER FRAME SHAPE	1.000	PC	0B1168A1	XEVC-1011-E EXT GLASS SUPPORT PROFILE	2.000	PC	0B1216A1	MM CT DOUBLE GLASS DOOR UPPER BEAM	1.000	PC	0B1217A1	MM DOUBLE GLASS DOOR INT UPPER BEAM 750	1.000	PC	CE1052A1	MM USB-CONTRO L PANEL CONNECTING CABLE	1.000	PC	CE1053B0	MM MICROFIT LED BAR POWER SUPPLY CABL	1.000	PC
Code	Description	Qty	UOM																																											
0B1116A0	XEVC-1011-E LEFT EXT DOOR COLUM	1.000	PC																																											
0B1117A2	1011 RIGHT - DOOR LEFT INT COLUMN	1.000	PC																																											
0B1118B1	XEVC-1011 DOOR RIGHT EXTERNAL COLUMN	1.000	PC																																											
0B1119A2	1011 RIGHT - DOOR RIGHT INT COLUMN	1.000	PC																																											
0B1122A1	750MM DOOR LOWER FRAME SHAPE	1.000	PC																																											
0B1168A1	XEVC-1011-E EXT GLASS SUPPORT PROFILE	2.000	PC																																											
0B1216A1	MM CT DOUBLE GLASS DOOR UPPER BEAM	1.000	PC																																											
0B1217A1	MM DOUBLE GLASS DOOR INT UPPER BEAM 750	1.000	PC																																											
CE1052A1	MM USB-CONTRO L PANEL CONNECTING CABLE	1.000	PC																																											
CE1053B0	MM MICROFIT LED BAR POWER SUPPLY CABL	1.000	PC																																											





COMPONENT			SPARE PART					
Code	Description	Image	Code	Description	Kit components			
OB1116A	XEVC-1011-E LEFT EXT DOOR COLUMN		KDR1263A	1011 RIGHT EXTERNAL DOOR KI	Code	Description	Qty	UOM
					CE1285A0	EMI ROUND FERRITE MOD.26438015 02	1.000	PC
					CE1290A0	EXTRACTABL E FEMALE TERMINAL CPF 5/4	1.000	PC
					CE1310A1	POWER - CONTROL BOARD CONNECTING CABLE	1.000	PC
					GN1525A0	O-RING INT DIAM 9,5 THK 1 NBR 70	1.000	PC
					LP1021A0	6 SERIES L600 LED LIGHT BAR - E750	1.000	PC
					LP1027A0	L750 MM NO LED LIGHT BAR COVER	1.000	PC
					MG1083A2	MM COMPLETE HANDLE	1.000	PC
					SL1170A1	S57 BLACK SILICON - 310ml CARTRIDGE	43.000	ML
					VE1030A1	MAGNET FOR DOOR MICROSWITC H D=22.9mm	1.000	PC
					VI1034A0	STAINLESS STEEL WASHER 8.4x16x1	1.000	PC
					VH1147A0	5X25 STAINLESS STEEL SCREW	16.000	PC
					VH1220A1	4,2x12 TCB SELF-TAPPIN G SCREW	23.000	PC
					VI1996A0	M5x35 SCREW	13.000	PC
					VM1630A1	INTERNAL GLASS PUSHING CAP	1.000	PC
					VM1631A0	PLUS INNER GLASS PUSHING CAP	3.000	PC
					VM2259A1	6 SERIES DOOR LOWER LEFT CAP	1.000	PC



COMPONENT			SPARE PART					
Code	Description	Image	Code	Description	Kit components			
OB1116A	XEVC-1011-E LEFT EXT DOOR COLUMN		KDR1263A	1011 RIGHT EXTERNAL DOOR KI	Code	Description	Qty	UOM
					VM2260A1	6 SERIES DOOR UPPER LEFT CAP	1.000	PC
					VM2261A1	MM DOOR LOWER RIGHT CAP	1.000	PC
					VM2262A1	MM DOOR UPPER RIGHT CAP	1.000	PC
					VM2267A1		2.000	PC
					VM2268A0	DOOR MAGNET COVER	2.000	PC
					VM2269A0	INTERNAL GLASS LOCKING SYSTEM CAP	2.000	PC
					VM2274A0	GROOVED BUSHING	1.000	PC
					VM2275A0	SMOOTH BUSHING	1.000	PC
					VM2284A0	750 SERIES DRIP PROFILE	1.000	PC
					VM2305A0	MM SERIES DOOR CAP FIXING PAWL	14.000	PC
					VM2312A0	MM DRIP PROFILE DRAIN LEFT PIPE	1.000	PC
					VM2313A0	MM DRIP TRAY RIGHT DRAIN PIPE	1.000	PC
					VM2314A0	MM DRIP PROFILE CAP	1.000	PC
					VM2315A0	MIND.Maps INTERNAL GLASS CAP SUPPORT	1.000	PC
					VM2410A0	PLATE TO STOP EXTRUDED LED BAR	2.000	PC
					VM2505A0	MM PLUS INTERNAL GLASS SUPPORT	3.000	PC
					VM2518A0	BOARD COOLING FAN SUPPORT	1.000	PC
					VN1179A1	CONTROL BOARD 40x40x20mm 12V COOLING FAN	1.000	PC
					VT1278A0	EXTERNAL GLASS SER. XEVC-1011-E	1.000	PC



COMPONENT			SPARE PART																																																										
Code	Description	Image	Code	Description	Kit components																																																								
0B1117A	1011 RIGHT - DOOR LEFT INT COLUMN		OUTOFPRODUCTIO	ITEM OUT OF PRODUCTION																																																									
0B1118B	XEVC-1011 DOOR RIGHT EXTERNAL COLUMN		KDR1308A	1011 ZERO -M RIGHT COMPLETE DOOR KIT	<table border="1"> <thead> <tr> <th>Code</th> <th>Description</th> <th>Qty</th> <th>UOM</th> </tr> </thead> <tbody> <tr> <td>0B1116A0</td> <td>XEVC-1011-E LEFT EXT DOOR COLUMN</td> <td>1.000</td> <td>PC</td> </tr> <tr> <td>0B1117A2</td> <td>1011 RIGHT - DOOR LEFT INT COLUMN</td> <td>1.000</td> <td>PC</td> </tr> <tr> <td>0B1118B1</td> <td>XEVC-1011 DOOR RIGHT EXTERNAL COLUMN</td> <td>1.000</td> <td>PC</td> </tr> <tr> <td>0B1119A2</td> <td>1011 RIGHT - DOOR RIGHT INT COLUMN</td> <td>1.000</td> <td>PC</td> </tr> <tr> <td>0B1122B0</td> <td>MM CT 750mm DOOR LOWER BEAM</td> <td>1.000</td> <td>PC</td> </tr> <tr> <td>0B1168A1</td> <td>XEVC-1011-E EXT GLASS SUPPORT PROFILE</td> <td>2.000</td> <td>PC</td> </tr> <tr> <td>0B1216B0</td> <td>MM DOUBLE GLASS DOOR 750mm UPPER BEAM</td> <td>1.000</td> <td>PC</td> </tr> <tr> <td>0B1217A1</td> <td>MM DOUBLE GLASS DOOR INT UPPER BEAM 750</td> <td>1.000</td> <td>PC</td> </tr> <tr> <td>0H2892A0</td> <td>LED BAR UPPER CAP PLATE</td> <td>1.000</td> <td>PC</td> </tr> <tr> <td>0H2893A0</td> <td>LED BAR LOWER CAP PLATE</td> <td>1.000</td> <td>PC</td> </tr> <tr> <td>CE1097A0</td> <td>4M SIHF 4 POLES MICROFIT CANBUS</td> <td>1.000</td> <td>PC</td> </tr> <tr> <td>CE1285A0</td> <td>EMI ROUND FERRITE MOD.26438015 02</td> <td>2.000</td> <td>PC</td> </tr> <tr> <td>CE1851A0</td> <td>MICROFIT CABLE 2P M-F-F AWG22</td> <td>1.000</td> <td>PC</td> </tr> </tbody> </table>	Code	Description	Qty	UOM	0B1116A0	XEVC-1011-E LEFT EXT DOOR COLUMN	1.000	PC	0B1117A2	1011 RIGHT - DOOR LEFT INT COLUMN	1.000	PC	0B1118B1	XEVC-1011 DOOR RIGHT EXTERNAL COLUMN	1.000	PC	0B1119A2	1011 RIGHT - DOOR RIGHT INT COLUMN	1.000	PC	0B1122B0	MM CT 750mm DOOR LOWER BEAM	1.000	PC	0B1168A1	XEVC-1011-E EXT GLASS SUPPORT PROFILE	2.000	PC	0B1216B0	MM DOUBLE GLASS DOOR 750mm UPPER BEAM	1.000	PC	0B1217A1	MM DOUBLE GLASS DOOR INT UPPER BEAM 750	1.000	PC	0H2892A0	LED BAR UPPER CAP PLATE	1.000	PC	0H2893A0	LED BAR LOWER CAP PLATE	1.000	PC	CE1097A0	4M SIHF 4 POLES MICROFIT CANBUS	1.000	PC	CE1285A0	EMI ROUND FERRITE MOD.26438015 02	2.000	PC	CE1851A0	MICROFIT CABLE 2P M-F-F AWG22	1.000	PC
Code	Description	Qty	UOM																																																										
0B1116A0	XEVC-1011-E LEFT EXT DOOR COLUMN	1.000	PC																																																										
0B1117A2	1011 RIGHT - DOOR LEFT INT COLUMN	1.000	PC																																																										
0B1118B1	XEVC-1011 DOOR RIGHT EXTERNAL COLUMN	1.000	PC																																																										
0B1119A2	1011 RIGHT - DOOR RIGHT INT COLUMN	1.000	PC																																																										
0B1122B0	MM CT 750mm DOOR LOWER BEAM	1.000	PC																																																										
0B1168A1	XEVC-1011-E EXT GLASS SUPPORT PROFILE	2.000	PC																																																										
0B1216B0	MM DOUBLE GLASS DOOR 750mm UPPER BEAM	1.000	PC																																																										
0B1217A1	MM DOUBLE GLASS DOOR INT UPPER BEAM 750	1.000	PC																																																										
0H2892A0	LED BAR UPPER CAP PLATE	1.000	PC																																																										
0H2893A0	LED BAR LOWER CAP PLATE	1.000	PC																																																										
CE1097A0	4M SIHF 4 POLES MICROFIT CANBUS	1.000	PC																																																										
CE1285A0	EMI ROUND FERRITE MOD.26438015 02	2.000	PC																																																										
CE1851A0	MICROFIT CABLE 2P M-F-F AWG22	1.000	PC																																																										



COMPONENT			SPARE PART					
Code	Description	Image	Code	Description	Kit components			
OB1118B	XEVC-1011 DOOR RIGHT EXTERNAL COLUMN		KDR1308A	1011 ZERO -M RIGHT COMPLETE DOOR KIT	Code	Description	Qty	UOM
					CE2006A1	MICROFIT CABLE 2PM-400-AMP MODU2 2PF	1.000	PC
					GN1525A0	O-RING INT DIAM 9,5 THK 1 NBR 70	1.000	PC
					LP1056A0	S6 L400 E750 LED BAR	1.000	PC
					MG1099A1	MM COMPLETE HANDLE	1.000	PC
					SL1170A1	S57 BLACK SILICON - 310ml CARTRIDGE	43.000	ML
					SL1221A0	GN1/1 EXTERNAL GLASS UPPER SILICONE	1.000	PC
					SL1226A0	1011 EXTERNAL GLASS LATERAL SILICONE	4.000	PC
					VE1030A1	MAGNET FOR DOOR MICROSWITC H D=22,9mm	1.000	PC
					VI1034A0	STAINLESS STEEL WASHER 8,4x16x1	1.000	PC
					VI1074A0	4X16 SCREW FOR PLASTIC	4.000	PC
					VI1174A0		16.000	PC
					VI1220A1	4,2x12 TCB SELF-TAPPIN G SCREW	30.000	PC
					VI1565A0	WASHER INTD=4.2 EXTD=20 TH=125/10 INO	1.000	PC
					VI1996A0	M5x35 SCREW	13.000	PC
					VM1490A0	CHEFTOP/BAK ERTOP HANDLE SCREWS COVER	2.000	PC
					VM1630A1	INTERNAL GLASS PUSHING CAP	5.000	PC
VM1631A0	PLUS INNER GLASS PUSHING CAP	5.000	PC					



COMPONENT			SPARE PART																																																																																					
Code	Description	Image	Code	Description	Kit components																																																																																			
0B1118B	XEVC-1011 DOOR RIGHT EXTERNAL COLUMN		KDR1308A	1011 ZERO -M RIGHT COMPLETE DOOR KIT	<table border="1"> <thead> <tr> <th>Code</th> <th>Description</th> <th>Qty</th> <th>UOM</th> </tr> </thead> <tbody> <tr> <td>VM2259B0</td> <td>VM2259B0</td> <td>1.000</td> <td>PC</td> </tr> <tr> <td>VM2268A0</td> <td>DOOR MAGNET COVER</td> <td>1.000</td> <td>PC</td> </tr> <tr> <td>VM2274A0</td> <td>GROOVED BUSHING</td> <td>1.000</td> <td>PC</td> </tr> <tr> <td>VM2275A0</td> <td>SMOOTH BUSHING</td> <td>1.000</td> <td>PC</td> </tr> <tr> <td>VM2284B0</td> <td>750 SERIES DRIP PROFILE KIT</td> <td>1.000</td> <td>PC</td> </tr> <tr> <td>VM2305A0</td> <td>MM SERIES DOOR CAP FIXING PAWL</td> <td>14.000</td> <td>PC</td> </tr> <tr> <td>VM2312A0</td> <td>MM DRIP PROFILE DRAIN LEFT PIPE</td> <td>1.000</td> <td>PC</td> </tr> <tr> <td>VM2314A0</td> <td>MM DRIP PROFILE CAP</td> <td>1.000</td> <td>PC</td> </tr> <tr> <td>VM2315B0</td> <td>MM - M INNER GLASS PUSHING CAP HOLDER</td> <td>5.000</td> <td>PC</td> </tr> <tr> <td>VM2410A0</td> <td>PLATE TO STOP EXTRUDED LED BAR</td> <td>1.000</td> <td>PC</td> </tr> <tr> <td>VM2505B1</td> <td>MM PLUS INTERNAL GLASS SUPPORT</td> <td>5.000</td> <td>PC</td> </tr> <tr> <td>VM2956A0</td> <td></td> <td>1.000</td> <td>PC</td> </tr> <tr> <td>VM2957A0</td> <td></td> <td>1.000</td> <td>PC</td> </tr> <tr> <td>VM2958A0</td> <td>MM - M DOOR LEFT UPPPER CAP ASSEMBL</td> <td>1.000</td> <td>PC</td> </tr> <tr> <td>VP1080A0</td> <td>UPPER HINGE CAP FOR LOWER INNER GLASS</td> <td>1.000</td> <td>PC</td> </tr> <tr> <td>VT1278A0</td> <td>EXTERNAL GLASS SER . XEVC-1011-E</td> <td>1.000</td> <td>PC</td> </tr> </tbody> </table>	Code	Description	Qty	UOM	VM2259B0	VM2259B0	1.000	PC	VM2268A0	DOOR MAGNET COVER	1.000	PC	VM2274A0	GROOVED BUSHING	1.000	PC	VM2275A0	SMOOTH BUSHING	1.000	PC	VM2284B0	750 SERIES DRIP PROFILE KIT	1.000	PC	VM2305A0	MM SERIES DOOR CAP FIXING PAWL	14.000	PC	VM2312A0	MM DRIP PROFILE DRAIN LEFT PIPE	1.000	PC	VM2314A0	MM DRIP PROFILE CAP	1.000	PC	VM2315B0	MM - M INNER GLASS PUSHING CAP HOLDER	5.000	PC	VM2410A0	PLATE TO STOP EXTRUDED LED BAR	1.000	PC	VM2505B1	MM PLUS INTERNAL GLASS SUPPORT	5.000	PC	VM2956A0		1.000	PC	VM2957A0		1.000	PC	VM2958A0	MM - M DOOR LEFT UPPPER CAP ASSEMBL	1.000	PC	VP1080A0	UPPER HINGE CAP FOR LOWER INNER GLASS	1.000	PC	VT1278A0	EXTERNAL GLASS SER . XEVC-1011-E	1.000	PC	KDR1263B	1011 -M RIGHT EXTERNAL DOOR	<table border="1"> <thead> <tr> <th>Code</th> <th>Description</th> <th>Qty</th> <th>UOM</th> </tr> </thead> <tbody> <tr> <td>0B1116A0</td> <td>XEVC-1011-E LEFT EXT DOOR COLUM</td> <td>1.000</td> <td>PC</td> </tr> <tr> <td>0B1117A2</td> <td>1011 RIGHT - DOOR LEFT INT COLUMN</td> <td>1.000</td> <td>PC</td> </tr> </tbody> </table>	Code	Description	Qty	UOM	0B1116A0	XEVC-1011-E LEFT EXT DOOR COLUM	1.000	PC	0B1117A2	1011 RIGHT - DOOR LEFT INT COLUMN	1.000	PC
			Code	Description	Qty	UOM																																																																																		
VM2259B0	VM2259B0	1.000	PC																																																																																					
VM2268A0	DOOR MAGNET COVER	1.000	PC																																																																																					
VM2274A0	GROOVED BUSHING	1.000	PC																																																																																					
VM2275A0	SMOOTH BUSHING	1.000	PC																																																																																					
VM2284B0	750 SERIES DRIP PROFILE KIT	1.000	PC																																																																																					
VM2305A0	MM SERIES DOOR CAP FIXING PAWL	14.000	PC																																																																																					
VM2312A0	MM DRIP PROFILE DRAIN LEFT PIPE	1.000	PC																																																																																					
VM2314A0	MM DRIP PROFILE CAP	1.000	PC																																																																																					
VM2315B0	MM - M INNER GLASS PUSHING CAP HOLDER	5.000	PC																																																																																					
VM2410A0	PLATE TO STOP EXTRUDED LED BAR	1.000	PC																																																																																					
VM2505B1	MM PLUS INTERNAL GLASS SUPPORT	5.000	PC																																																																																					
VM2956A0		1.000	PC																																																																																					
VM2957A0		1.000	PC																																																																																					
VM2958A0	MM - M DOOR LEFT UPPPER CAP ASSEMBL	1.000	PC																																																																																					
VP1080A0	UPPER HINGE CAP FOR LOWER INNER GLASS	1.000	PC																																																																																					
VT1278A0	EXTERNAL GLASS SER . XEVC-1011-E	1.000	PC																																																																																					
Code	Description	Qty	UOM																																																																																					
0B1116A0	XEVC-1011-E LEFT EXT DOOR COLUM	1.000	PC																																																																																					
0B1117A2	1011 RIGHT - DOOR LEFT INT COLUMN	1.000	PC																																																																																					



COMPONENT			SPARE PART																																																																		
Code	Description	Image	Code	Description	Kit components																																																																
0B1118B	XEVC-1011 DOOR RIGHT EXTERNAL COLUMN		KDR1263B	1011 -M RIGHT EXTERNAL DOOR	<table border="1"> <thead> <tr> <th>Code</th> <th>Description</th> <th>Qty</th> <th>UOM</th> </tr> </thead> <tbody> <tr> <td>0B1118B1</td> <td>XEVC-1011 DOOR RIGHT EXTERNAL COLUMN</td> <td>1.000</td> <td>PC</td> </tr> <tr> <td>0B1119A2</td> <td>1011 RIGHT - DOOR RIGHT INT COLUMN</td> <td>1.000</td> <td>PC</td> </tr> <tr> <td>0B1122B0</td> <td>MM CT 750mm DOOR LOWER BEAM</td> <td>1.000</td> <td>PC</td> </tr> <tr> <td>0B1168A1</td> <td>XEVC-1011-E EXT GLASS SUPPORT PROFILE</td> <td>2.000</td> <td>PC</td> </tr> <tr> <td>0B1216B0</td> <td>MM DOUBLE GLASS DOOR 750mm UPPER BEAM</td> <td>1.000</td> <td>PC</td> </tr> <tr> <td>0B1217A1</td> <td>MM DOUBLE GLASS DOOR INT UPPER BEAM 750</td> <td>1.000</td> <td>PC</td> </tr> <tr> <td>CE1052A1</td> <td>MM USB-CONTRO L PANEL CONNECTING CABLE</td> <td>1.000</td> <td>PC</td> </tr> <tr> <td>CE1053B0</td> <td>MM MICROFIT LED BAR POWER SUPPLY CABL</td> <td>1.000</td> <td>PC</td> </tr> <tr> <td>CE1097A0</td> <td>4M SIHF 4 POLES MICROFIT CANBUS</td> <td>1.000</td> <td>PC</td> </tr> <tr> <td>CE1285A0</td> <td>EMI ROUND FERRITE MOD.26438015 02</td> <td>2.000</td> <td>PC</td> </tr> <tr> <td>GN1525A0</td> <td>O-RING INT DIAM 9,5 THK 1 NBR 70</td> <td>1.000</td> <td>PC</td> </tr> <tr> <td>LP1021A0</td> <td>6 SERIES L600 LED LIGHT BAR - E750</td> <td>1.000</td> <td>PC</td> </tr> <tr> <td>LP1027A0</td> <td>L750 MM NO LED LIGHT BAR COVER</td> <td>1.000</td> <td>PC</td> </tr> <tr> <td>MG1099A1</td> <td>MM COMPLETE HANDLE</td> <td>1.000</td> <td>PC</td> </tr> <tr> <td>SL1170A1</td> <td>S57 BLACK SILICON - 310ml CARTRIDGE</td> <td>43.000</td> <td>ML</td> </tr> </tbody> </table>	Code	Description	Qty	UOM	0B1118B1	XEVC-1011 DOOR RIGHT EXTERNAL COLUMN	1.000	PC	0B1119A2	1011 RIGHT - DOOR RIGHT INT COLUMN	1.000	PC	0B1122B0	MM CT 750mm DOOR LOWER BEAM	1.000	PC	0B1168A1	XEVC-1011-E EXT GLASS SUPPORT PROFILE	2.000	PC	0B1216B0	MM DOUBLE GLASS DOOR 750mm UPPER BEAM	1.000	PC	0B1217A1	MM DOUBLE GLASS DOOR INT UPPER BEAM 750	1.000	PC	CE1052A1	MM USB-CONTRO L PANEL CONNECTING CABLE	1.000	PC	CE1053B0	MM MICROFIT LED BAR POWER SUPPLY CABL	1.000	PC	CE1097A0	4M SIHF 4 POLES MICROFIT CANBUS	1.000	PC	CE1285A0	EMI ROUND FERRITE MOD.26438015 02	2.000	PC	GN1525A0	O-RING INT DIAM 9,5 THK 1 NBR 70	1.000	PC	LP1021A0	6 SERIES L600 LED LIGHT BAR - E750	1.000	PC	LP1027A0	L750 MM NO LED LIGHT BAR COVER	1.000	PC	MG1099A1	MM COMPLETE HANDLE	1.000	PC	SL1170A1	S57 BLACK SILICON - 310ml CARTRIDGE	43.000	ML
					Code	Description	Qty	UOM																																																													
					0B1118B1	XEVC-1011 DOOR RIGHT EXTERNAL COLUMN	1.000	PC																																																													
					0B1119A2	1011 RIGHT - DOOR RIGHT INT COLUMN	1.000	PC																																																													
					0B1122B0	MM CT 750mm DOOR LOWER BEAM	1.000	PC																																																													
					0B1168A1	XEVC-1011-E EXT GLASS SUPPORT PROFILE	2.000	PC																																																													
					0B1216B0	MM DOUBLE GLASS DOOR 750mm UPPER BEAM	1.000	PC																																																													
					0B1217A1	MM DOUBLE GLASS DOOR INT UPPER BEAM 750	1.000	PC																																																													
					CE1052A1	MM USB-CONTRO L PANEL CONNECTING CABLE	1.000	PC																																																													
					CE1053B0	MM MICROFIT LED BAR POWER SUPPLY CABL	1.000	PC																																																													
					CE1097A0	4M SIHF 4 POLES MICROFIT CANBUS	1.000	PC																																																													
					CE1285A0	EMI ROUND FERRITE MOD.26438015 02	2.000	PC																																																													
					GN1525A0	O-RING INT DIAM 9,5 THK 1 NBR 70	1.000	PC																																																													
					LP1021A0	6 SERIES L600 LED LIGHT BAR - E750	1.000	PC																																																													
					LP1027A0	L750 MM NO LED LIGHT BAR COVER	1.000	PC																																																													
MG1099A1	MM COMPLETE HANDLE	1.000	PC																																																																		
SL1170A1	S57 BLACK SILICON - 310ml CARTRIDGE	43.000	ML																																																																		



COMPONENT			SPARE PART																																																																																		
Code	Description	Image	Code	Description	Kit components																																																																																
0B1118B	XEVC-1011 DOOR RIGHT EXTERNAL COLUMN		KDR1263B	1011 -M RIGHT EXTERNAL DOOR	<table border="1"> <thead> <tr> <th>Code</th> <th>Description</th> <th>Qty</th> <th>UOM</th> </tr> </thead> <tbody> <tr> <td>SL1221A0</td> <td>GN1/1 EXTERNAL GLASS UPPER SILICONE</td> <td>1.000</td> <td>PC</td> </tr> <tr> <td>SL1226A0</td> <td>1011 EXTERNAL GLASS LATERAL SILICONE</td> <td>4.000</td> <td>PC</td> </tr> <tr> <td>VE1030A1</td> <td>MAGNET FOR DOOR MICROSWITC H D=22,9mm</td> <td>1.000</td> <td>PC</td> </tr> <tr> <td>VI1034A0</td> <td>STAINLESS STEEL WASHER 8.4x16x1</td> <td>1.000</td> <td>PC</td> </tr> <tr> <td>VI1074A0</td> <td>4X16 SCREW FOR PLASTIC</td> <td>4.000</td> <td>PC</td> </tr> <tr> <td>VI1174A0</td> <td></td> <td>16.000</td> <td>PC</td> </tr> <tr> <td>VI1220A1</td> <td>4,2x12 TCB SELF-TAPPIN G SCREW</td> <td>30.000</td> <td>PC</td> </tr> <tr> <td>VI1996A0</td> <td>M5x35 SCREW</td> <td>13.000</td> <td>PC</td> </tr> <tr> <td>VM1490A0</td> <td>CHEFTOP/BAK ERTOP HANDLE SCREWS COVER</td> <td>2.000</td> <td>PC</td> </tr> <tr> <td>VM1630A1</td> <td>INTERNAL GLASS PUSHING CAP</td> <td>5.000</td> <td>PC</td> </tr> <tr> <td>VM1631A0</td> <td>PLUS INNER GLASS PUSHING CAP</td> <td>5.000</td> <td>PC</td> </tr> <tr> <td>VM2259B0</td> <td>VM2259B0</td> <td>1.000</td> <td>PC</td> </tr> <tr> <td>VM2268A0</td> <td>DOOR MAGNET COVER</td> <td>1.000</td> <td>PC</td> </tr> <tr> <td>VM2274A0</td> <td>GROOVED BUSHING</td> <td>1.000</td> <td>PC</td> </tr> <tr> <td>VM2275A0</td> <td>SMOOTH BUSHING</td> <td>1.000</td> <td>PC</td> </tr> <tr> <td>VM2284B0</td> <td>750 SERIES DRIP PROFILE KIT</td> <td>1.000</td> <td>PC</td> </tr> <tr> <td>VM2305A0</td> <td>MM SERIES DOOR CAP FIXING PAWL</td> <td>14.000</td> <td>PC</td> </tr> <tr> <td>VM2312A0</td> <td>MM DRIP PROFILE DRAIN LEFT PIPE</td> <td>1.000</td> <td>PC</td> </tr> <tr> <td>VM2314A0</td> <td>MM DRIP PROFILE CAP</td> <td>1.000</td> <td>PC</td> </tr> </tbody> </table>	Code	Description	Qty	UOM	SL1221A0	GN1/1 EXTERNAL GLASS UPPER SILICONE	1.000	PC	SL1226A0	1011 EXTERNAL GLASS LATERAL SILICONE	4.000	PC	VE1030A1	MAGNET FOR DOOR MICROSWITC H D=22,9mm	1.000	PC	VI1034A0	STAINLESS STEEL WASHER 8.4x16x1	1.000	PC	VI1074A0	4X16 SCREW FOR PLASTIC	4.000	PC	VI1174A0		16.000	PC	VI1220A1	4,2x12 TCB SELF-TAPPIN G SCREW	30.000	PC	VI1996A0	M5x35 SCREW	13.000	PC	VM1490A0	CHEFTOP/BAK ERTOP HANDLE SCREWS COVER	2.000	PC	VM1630A1	INTERNAL GLASS PUSHING CAP	5.000	PC	VM1631A0	PLUS INNER GLASS PUSHING CAP	5.000	PC	VM2259B0	VM2259B0	1.000	PC	VM2268A0	DOOR MAGNET COVER	1.000	PC	VM2274A0	GROOVED BUSHING	1.000	PC	VM2275A0	SMOOTH BUSHING	1.000	PC	VM2284B0	750 SERIES DRIP PROFILE KIT	1.000	PC	VM2305A0	MM SERIES DOOR CAP FIXING PAWL	14.000	PC	VM2312A0	MM DRIP PROFILE DRAIN LEFT PIPE	1.000	PC	VM2314A0	MM DRIP PROFILE CAP	1.000	PC
					Code	Description	Qty	UOM																																																																													
					SL1221A0	GN1/1 EXTERNAL GLASS UPPER SILICONE	1.000	PC																																																																													
					SL1226A0	1011 EXTERNAL GLASS LATERAL SILICONE	4.000	PC																																																																													
					VE1030A1	MAGNET FOR DOOR MICROSWITC H D=22,9mm	1.000	PC																																																																													
					VI1034A0	STAINLESS STEEL WASHER 8.4x16x1	1.000	PC																																																																													
					VI1074A0	4X16 SCREW FOR PLASTIC	4.000	PC																																																																													
					VI1174A0		16.000	PC																																																																													
					VI1220A1	4,2x12 TCB SELF-TAPPIN G SCREW	30.000	PC																																																																													
					VI1996A0	M5x35 SCREW	13.000	PC																																																																													
					VM1490A0	CHEFTOP/BAK ERTOP HANDLE SCREWS COVER	2.000	PC																																																																													
					VM1630A1	INTERNAL GLASS PUSHING CAP	5.000	PC																																																																													
					VM1631A0	PLUS INNER GLASS PUSHING CAP	5.000	PC																																																																													
					VM2259B0	VM2259B0	1.000	PC																																																																													
					VM2268A0	DOOR MAGNET COVER	1.000	PC																																																																													
					VM2274A0	GROOVED BUSHING	1.000	PC																																																																													
					VM2275A0	SMOOTH BUSHING	1.000	PC																																																																													
					VM2284B0	750 SERIES DRIP PROFILE KIT	1.000	PC																																																																													
					VM2305A0	MM SERIES DOOR CAP FIXING PAWL	14.000	PC																																																																													
					VM2312A0	MM DRIP PROFILE DRAIN LEFT PIPE	1.000	PC																																																																													
VM2314A0	MM DRIP PROFILE CAP	1.000	PC																																																																																		



COMPONENT			SPARE PART																																						
Code	Description	Image	Code	Description	Kit components																																				
0B1118B	XEVC-1011 DOOR RIGHT EXTERNAL COLUMN		KDR1263B	1011 -M RIGHT EXTERNAL DOOR	<table border="1"> <thead> <tr> <th>Code</th> <th>Description</th> <th>Qty</th> <th>UOM</th> </tr> </thead> <tbody> <tr> <td>VM2315B0</td> <td>MM - M INNER GLASS PUSHING CAP HOLDER</td> <td>5.000</td> <td>PC</td> </tr> <tr> <td>VM2410A0</td> <td>PLATE TO STOP EXTRUDED LED BAR</td> <td>2.000</td> <td>PC</td> </tr> <tr> <td>VM2505B1</td> <td>MM PLUS INTERNAL GLASS SUPPORT</td> <td>5.000</td> <td>PC</td> </tr> <tr> <td>VM3008A0</td> <td></td> <td>1.000</td> <td>PC</td> </tr> <tr> <td>VM3010A0</td> <td></td> <td>1.000</td> <td>PC</td> </tr> <tr> <td>VM3011A0</td> <td></td> <td>1.000</td> <td>PC</td> </tr> <tr> <td>VP1080A0</td> <td>UPPER HINGE CAP FOR LOWER INNER GLASS</td> <td>1.000</td> <td>PC</td> </tr> <tr> <td>VT1278A0</td> <td>EXTERNAL GLASS SER. XEVC-1011-E</td> <td>1.000</td> <td>PC</td> </tr> </tbody> </table>	Code	Description	Qty	UOM	VM2315B0	MM - M INNER GLASS PUSHING CAP HOLDER	5.000	PC	VM2410A0	PLATE TO STOP EXTRUDED LED BAR	2.000	PC	VM2505B1	MM PLUS INTERNAL GLASS SUPPORT	5.000	PC	VM3008A0		1.000	PC	VM3010A0		1.000	PC	VM3011A0		1.000	PC	VP1080A0	UPPER HINGE CAP FOR LOWER INNER GLASS	1.000	PC	VT1278A0	EXTERNAL GLASS SER. XEVC-1011-E	1.000	PC
			Code	Description	Qty	UOM																																			
VM2315B0	MM - M INNER GLASS PUSHING CAP HOLDER	5.000	PC																																						
VM2410A0	PLATE TO STOP EXTRUDED LED BAR	2.000	PC																																						
VM2505B1	MM PLUS INTERNAL GLASS SUPPORT	5.000	PC																																						
VM3008A0		1.000	PC																																						
VM3010A0		1.000	PC																																						
VM3011A0		1.000	PC																																						
VP1080A0	UPPER HINGE CAP FOR LOWER INNER GLASS	1.000	PC																																						
VT1278A0	EXTERNAL GLASS SER. XEVC-1011-E	1.000	PC																																						
KDR1263A	1011 RIGHT EXTERNAL DOOR KI	<table border="1"> <thead> <tr> <th>Code</th> <th>Description</th> <th>Qty</th> <th>UOM</th> </tr> </thead> <tbody> <tr> <td>0B1116A0</td> <td>XEVC-1011-E LEFT EXT DOOR COLUM</td> <td>1.000</td> <td>PC</td> </tr> <tr> <td>0B1117A2</td> <td>1011 RIGHT - DOOR LEFT INT COLUMN</td> <td>1.000</td> <td>PC</td> </tr> <tr> <td>0B1118B1</td> <td>XEVC-1011 DOOR RIGHT EXTERNAL COLUMN</td> <td>1.000</td> <td>PC</td> </tr> <tr> <td>0B1119A2</td> <td>1011 RIGHT - DOOR RIGHT INT COLUMN</td> <td>1.000</td> <td>PC</td> </tr> <tr> <td>0B1122A1</td> <td>750MM DOOR LOWER FRAME SHAPE</td> <td>1.000</td> <td>PC</td> </tr> <tr> <td>0B1168A1</td> <td>XEVC-1011-E EXT GLASS SUPPORT PROFILE</td> <td>2.000</td> <td>PC</td> </tr> <tr> <td>0B1216A1</td> <td>MM CT DOUBLE GLASS DOOR UPPER BEAM</td> <td>1.000</td> <td>PC</td> </tr> <tr> <td>0B1217A1</td> <td>MM DOUBLE GLASS DOOR INT UPPER BEAM 750</td> <td>1.000</td> <td>PC</td> </tr> </tbody> </table>	Code	Description	Qty	UOM	0B1116A0	XEVC-1011-E LEFT EXT DOOR COLUM	1.000	PC	0B1117A2	1011 RIGHT - DOOR LEFT INT COLUMN	1.000	PC	0B1118B1	XEVC-1011 DOOR RIGHT EXTERNAL COLUMN	1.000	PC	0B1119A2	1011 RIGHT - DOOR RIGHT INT COLUMN	1.000	PC	0B1122A1	750MM DOOR LOWER FRAME SHAPE	1.000	PC	0B1168A1	XEVC-1011-E EXT GLASS SUPPORT PROFILE	2.000	PC	0B1216A1	MM CT DOUBLE GLASS DOOR UPPER BEAM	1.000	PC	0B1217A1	MM DOUBLE GLASS DOOR INT UPPER BEAM 750	1.000	PC			
Code	Description	Qty	UOM																																						
0B1116A0	XEVC-1011-E LEFT EXT DOOR COLUM	1.000	PC																																						
0B1117A2	1011 RIGHT - DOOR LEFT INT COLUMN	1.000	PC																																						
0B1118B1	XEVC-1011 DOOR RIGHT EXTERNAL COLUMN	1.000	PC																																						
0B1119A2	1011 RIGHT - DOOR RIGHT INT COLUMN	1.000	PC																																						
0B1122A1	750MM DOOR LOWER FRAME SHAPE	1.000	PC																																						
0B1168A1	XEVC-1011-E EXT GLASS SUPPORT PROFILE	2.000	PC																																						
0B1216A1	MM CT DOUBLE GLASS DOOR UPPER BEAM	1.000	PC																																						
0B1217A1	MM DOUBLE GLASS DOOR INT UPPER BEAM 750	1.000	PC																																						





COMPONENT			SPARE PART																																																																		
Code	Description	Image	Code	Description	Kit components																																																																
0B1118B	XEVC-1011 DOOR RIGHT EXTERNAL COLUMN		KDR1263A	1011 RIGHT EXTERNAL DOOR KI	<table border="1"> <thead> <tr> <th>Code</th> <th>Description</th> <th>Qty</th> <th>UOM</th> </tr> </thead> <tbody> <tr> <td>CE1052A1</td> <td>MM USB-CONTRO L PANEL CONNECTING CABLE</td> <td>1.000</td> <td>PC</td> </tr> <tr> <td>CE1053B0</td> <td>MM MICROFIT LED BAR POWER SUPPLY CABL</td> <td>1.000</td> <td>PC</td> </tr> <tr> <td>CE1285A0</td> <td>EMI ROUND FERRITE MOD.26438015 02</td> <td>1.000</td> <td>PC</td> </tr> <tr> <td>CE1290A0</td> <td>EXTRACTABL E FEMALE TERMINAL CPF 5/4</td> <td>1.000</td> <td>PC</td> </tr> <tr> <td>CE1310A1</td> <td>POWER - CONTROL BOARD CONNECTING CABLE</td> <td>1.000</td> <td>PC</td> </tr> <tr> <td>GN1525A0</td> <td>O-RING INT DIAM 9,5 THK 1 NBR 70</td> <td>1.000</td> <td>PC</td> </tr> <tr> <td>LP1021A0</td> <td>6 SERIES L600 LED LIGHT BAR - E750</td> <td>1.000</td> <td>PC</td> </tr> <tr> <td>LP1027A0</td> <td>L750 MM NO LED LIGHT BAR COVER</td> <td>1.000</td> <td>PC</td> </tr> <tr> <td>MG1083A2</td> <td>MM COMPLETE HANDLE</td> <td>1.000</td> <td>PC</td> </tr> <tr> <td>SL1170A1</td> <td>S57 BLACK SILICON - 310ml CARTRIDGE</td> <td>43.000</td> <td>ML</td> </tr> <tr> <td>VE1030A1</td> <td>MAGNET FOR DOOR MICROSWITC H D=22,9mm</td> <td>1.000</td> <td>PC</td> </tr> <tr> <td>VI1034A0</td> <td>STAINLESS STEEL WASHER 8,4x16x1</td> <td>1.000</td> <td>PC</td> </tr> <tr> <td>VI1147A0</td> <td>5X25 STAINLESS STEEL SCREW</td> <td>16.000</td> <td>PC</td> </tr> <tr> <td>VI1220A1</td> <td>4,2x12 TCB SELF-TAPPIN G SCREW</td> <td>23.000</td> <td>PC</td> </tr> <tr> <td>VI1996A0</td> <td>M5x35 SCREW</td> <td>13.000</td> <td>PC</td> </tr> </tbody> </table>	Code	Description	Qty	UOM	CE1052A1	MM USB-CONTRO L PANEL CONNECTING CABLE	1.000	PC	CE1053B0	MM MICROFIT LED BAR POWER SUPPLY CABL	1.000	PC	CE1285A0	EMI ROUND FERRITE MOD.26438015 02	1.000	PC	CE1290A0	EXTRACTABL E FEMALE TERMINAL CPF 5/4	1.000	PC	CE1310A1	POWER - CONTROL BOARD CONNECTING CABLE	1.000	PC	GN1525A0	O-RING INT DIAM 9,5 THK 1 NBR 70	1.000	PC	LP1021A0	6 SERIES L600 LED LIGHT BAR - E750	1.000	PC	LP1027A0	L750 MM NO LED LIGHT BAR COVER	1.000	PC	MG1083A2	MM COMPLETE HANDLE	1.000	PC	SL1170A1	S57 BLACK SILICON - 310ml CARTRIDGE	43.000	ML	VE1030A1	MAGNET FOR DOOR MICROSWITC H D=22,9mm	1.000	PC	VI1034A0	STAINLESS STEEL WASHER 8,4x16x1	1.000	PC	VI1147A0	5X25 STAINLESS STEEL SCREW	16.000	PC	VI1220A1	4,2x12 TCB SELF-TAPPIN G SCREW	23.000	PC	VI1996A0	M5x35 SCREW	13.000	PC
Code	Description	Qty	UOM																																																																		
CE1052A1	MM USB-CONTRO L PANEL CONNECTING CABLE	1.000	PC																																																																		
CE1053B0	MM MICROFIT LED BAR POWER SUPPLY CABL	1.000	PC																																																																		
CE1285A0	EMI ROUND FERRITE MOD.26438015 02	1.000	PC																																																																		
CE1290A0	EXTRACTABL E FEMALE TERMINAL CPF 5/4	1.000	PC																																																																		
CE1310A1	POWER - CONTROL BOARD CONNECTING CABLE	1.000	PC																																																																		
GN1525A0	O-RING INT DIAM 9,5 THK 1 NBR 70	1.000	PC																																																																		
LP1021A0	6 SERIES L600 LED LIGHT BAR - E750	1.000	PC																																																																		
LP1027A0	L750 MM NO LED LIGHT BAR COVER	1.000	PC																																																																		
MG1083A2	MM COMPLETE HANDLE	1.000	PC																																																																		
SL1170A1	S57 BLACK SILICON - 310ml CARTRIDGE	43.000	ML																																																																		
VE1030A1	MAGNET FOR DOOR MICROSWITC H D=22,9mm	1.000	PC																																																																		
VI1034A0	STAINLESS STEEL WASHER 8,4x16x1	1.000	PC																																																																		
VI1147A0	5X25 STAINLESS STEEL SCREW	16.000	PC																																																																		
VI1220A1	4,2x12 TCB SELF-TAPPIN G SCREW	23.000	PC																																																																		
VI1996A0	M5x35 SCREW	13.000	PC																																																																		





COMPONENT			SPARE PART					
Code	Description	Image	Code	Description	Kit components			
0B1118B	XEVC-1011 DOOR RIGHT EXTERNAL COLUMN		KDR1263A	1011 RIGHT EXTERNAL DOOR KI	Code	Description	Qty	UOM
					VM1630A1	INTERNAL GLASS PUSHING CAP	1.000	PC
					VM1631A0	PLUS INNER GLASS PUSHING CAP	3.000	PC
					VM2259A1	6 SERIES DOOR LOWER LEFT CAP	1.000	PC
					VM2260A1	6 SERIES DOOR UPPER LEFT CAP	1.000	PC
					VM2261A1	MM DOOR LOWER RIGHT CAP	1.000	PC
					VM2262A1	MM DOOR UPPER RIGHT CAP	1.000	PC
					VM2267A1		2.000	PC
					VM2268A0	DOOR MAGNET COVER	2.000	PC
					VM2269A0	INTERNAL GLASS LOCKING SYSTEM CAP	2.000	PC
					VM2274A0	GROOVED BUSHING	1.000	PC
					VM2275A0	SMOOTH BUSHING	1.000	PC
					VM2284A0	750 SERIES DRIP PROFILE	1.000	PC
					VM2305A0	MM SERIES DOOR CAP FIXING PAWL	14.000	PC
					VM2312A0	MM DRIP PROFILE DRAIN LEFT PIPE	1.000	PC
					VM2313A0	MM DRIP TRAY RIGHT DRAIN PIPE	1.000	PC
					VM2314A0	MM DRIP PROFILE CAP	1.000	PC
					VM2315A0	MIND.Maps INTERNAL GLASS CAP SUPPORT	1.000	PC
					VM2410A0	PLATE TO STOP EXTRUDED LED BAR	2.000	PC



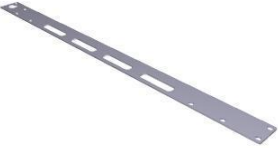

COMPONENT			SPARE PART																																																														
Code	Description	Image	Code	Description	Kit components																																																												
0B1118B	XEVC-1011 DOOR RIGHT EXTERNAL COLUMN		KDR1263A	1011 RIGHT EXTERNAL DOOR KI	<table border="1"> <thead> <tr> <th>Code</th> <th>Description</th> <th>Qty</th> <th>UOM</th> </tr> </thead> <tbody> <tr> <td>VM2505A0</td> <td>MM PLUS INTERNAL GLASS SUPPORT</td> <td>3.000</td> <td>PC</td> </tr> <tr> <td>VM2518A0</td> <td>BOARD COOLING FAN SUPPORT</td> <td>1.000</td> <td>PC</td> </tr> <tr> <td>VN1179A1</td> <td>CONTROL BOARD 40x40x20mm 12V COOLING FAN</td> <td>1.000</td> <td>PC</td> </tr> <tr> <td>VT1278A0</td> <td>EXTERNAL GLASS SER . XEVC-1011-E</td> <td>1.000</td> <td>PC</td> </tr> </tbody> </table>	Code	Description	Qty	UOM	VM2505A0	MM PLUS INTERNAL GLASS SUPPORT	3.000	PC	VM2518A0	BOARD COOLING FAN SUPPORT	1.000	PC	VN1179A1	CONTROL BOARD 40x40x20mm 12V COOLING FAN	1.000	PC	VT1278A0	EXTERNAL GLASS SER . XEVC-1011-E	1.000	PC																																								
Code	Description	Qty	UOM																																																														
VM2505A0	MM PLUS INTERNAL GLASS SUPPORT	3.000	PC																																																														
VM2518A0	BOARD COOLING FAN SUPPORT	1.000	PC																																																														
VN1179A1	CONTROL BOARD 40x40x20mm 12V COOLING FAN	1.000	PC																																																														
VT1278A0	EXTERNAL GLASS SER . XEVC-1011-E	1.000	PC																																																														
0B1119A	1011 RIGHT - DOOR RIGHT INT COLUMN		OUTOFPRODUCTIO	ITEM OUT OF PRODUCTION																																																													
0B1122B	MM CT 750mm DOOR LOWER BEA		K0B1122BR	CHEFTOP MM -M RIGHT DOOR LOWER BEAM KIT	<table border="1"> <thead> <tr> <th>Code</th> <th>Description</th> <th>Qty</th> <th>UOM</th> </tr> </thead> <tbody> <tr> <td>0B1122B0</td> <td>MM CT 750mm DOOR LOWER BEAM</td> <td>1.000</td> <td>PC</td> </tr> <tr> <td>VE1030A1</td> <td>MAGNET FOR DOOR MICROSWITC H D=22,9mm</td> <td>1.000</td> <td>PC</td> </tr> <tr> <td>VI1074A0</td> <td>4X16 SCREW FOR PLASTIC</td> <td>1.000</td> <td>PC</td> </tr> <tr> <td>VI1174A0</td> <td></td> <td>8.000</td> <td>PC</td> </tr> <tr> <td>VI1220A1</td> <td>4,2x12 TCB SELF-TAPPIN G SCREW</td> <td>1.000</td> <td>PC</td> </tr> <tr> <td>VI1996A0</td> <td>M5x35 SCREW</td> <td>7.000</td> <td>PC</td> </tr> <tr> <td>VM1794A0</td> <td>250x4.8 PA66 BLACK CLAMP</td> <td>2.000</td> <td>PC</td> </tr> <tr> <td>VM2103A0</td> <td>CLAMP LOCK</td> <td>2.000</td> <td>PC</td> </tr> <tr> <td>VM2259B0</td> <td>VM2259B0</td> <td>1.000</td> <td>PC</td> </tr> <tr> <td>VM2268A0</td> <td>DOOR MAGNET COVER</td> <td>1.000</td> <td>PC</td> </tr> <tr> <td>VM2274A0</td> <td>GROOVED BUSHING</td> <td>1.000</td> <td>PC</td> </tr> <tr> <td>VM2305A0</td> <td>MM SERIES DOOR CAP FIXING PAWL</td> <td>7.000</td> <td>PC</td> </tr> <tr> <td>VM3010A0</td> <td></td> <td>1.000</td> <td>PC</td> </tr> <tr> <td>VP1080A0</td> <td>UPPER HINGE CAP FOR LOWER INNER GLASS</td> <td>1.000</td> <td>PC</td> </tr> </tbody> </table>	Code	Description	Qty	UOM	0B1122B0	MM CT 750mm DOOR LOWER BEAM	1.000	PC	VE1030A1	MAGNET FOR DOOR MICROSWITC H D=22,9mm	1.000	PC	VI1074A0	4X16 SCREW FOR PLASTIC	1.000	PC	VI1174A0		8.000	PC	VI1220A1	4,2x12 TCB SELF-TAPPIN G SCREW	1.000	PC	VI1996A0	M5x35 SCREW	7.000	PC	VM1794A0	250x4.8 PA66 BLACK CLAMP	2.000	PC	VM2103A0	CLAMP LOCK	2.000	PC	VM2259B0	VM2259B0	1.000	PC	VM2268A0	DOOR MAGNET COVER	1.000	PC	VM2274A0	GROOVED BUSHING	1.000	PC	VM2305A0	MM SERIES DOOR CAP FIXING PAWL	7.000	PC	VM3010A0		1.000	PC	VP1080A0	UPPER HINGE CAP FOR LOWER INNER GLASS	1.000	PC
Code	Description	Qty	UOM																																																														
0B1122B0	MM CT 750mm DOOR LOWER BEAM	1.000	PC																																																														
VE1030A1	MAGNET FOR DOOR MICROSWITC H D=22,9mm	1.000	PC																																																														
VI1074A0	4X16 SCREW FOR PLASTIC	1.000	PC																																																														
VI1174A0		8.000	PC																																																														
VI1220A1	4,2x12 TCB SELF-TAPPIN G SCREW	1.000	PC																																																														
VI1996A0	M5x35 SCREW	7.000	PC																																																														
VM1794A0	250x4.8 PA66 BLACK CLAMP	2.000	PC																																																														
VM2103A0	CLAMP LOCK	2.000	PC																																																														
VM2259B0	VM2259B0	1.000	PC																																																														
VM2268A0	DOOR MAGNET COVER	1.000	PC																																																														
VM2274A0	GROOVED BUSHING	1.000	PC																																																														
VM2305A0	MM SERIES DOOR CAP FIXING PAWL	7.000	PC																																																														
VM3010A0		1.000	PC																																																														
VP1080A0	UPPER HINGE CAP FOR LOWER INNER GLASS	1.000	PC																																																														



COMPONENT			SPARE PART																																																										
Code	Description	Image	Code	Description	Kit components																																																								
0B1122B	MM CT 750mm DOOR LOWER BEA		K0B1122BL	CHEFTOP MM -M LEFT DOOR LOWER BEAM KIT	<table border="1"> <thead> <tr> <th>Code</th> <th>Description</th> <th>Qty</th> <th>UOM</th> </tr> </thead> <tbody> <tr> <td>0B1122B0</td> <td>MM CT 750mm DOOR LOWER BEAM</td> <td>1.000</td> <td>PC</td> </tr> <tr> <td>VE1030A1</td> <td>MAGNET FOR DOOR MICROSWITC H D=22.9mm</td> <td>1.000</td> <td>PC</td> </tr> <tr> <td>VI1074A0</td> <td>4X16 SCREW FOR PLASTIC</td> <td>1.000</td> <td>PC</td> </tr> <tr> <td>VI1174A0</td> <td></td> <td>8.000</td> <td>PC</td> </tr> <tr> <td>VI1220A1</td> <td>4.2x12 TCB SELF-TAPPIN G SCREW</td> <td>1.000</td> <td>PC</td> </tr> <tr> <td>VI1996A0</td> <td>M5x35 SCREW</td> <td>6.000</td> <td>PC</td> </tr> <tr> <td>VM1794A0</td> <td>250x4.8 PA66 BLACK CLAMP</td> <td>2.000</td> <td>PC</td> </tr> <tr> <td>VM2103A0</td> <td>CLAMP LOCK</td> <td>2.000</td> <td>PC</td> </tr> <tr> <td>VM2274A0</td> <td>GROOVED BUSHING</td> <td>1.000</td> <td>PC</td> </tr> <tr> <td>VM2305A0</td> <td>MM SERIES DOOR CAP FIXING PAWL</td> <td>7.000</td> <td>PC</td> </tr> <tr> <td>VM2384B0</td> <td>MM LEFT DOOR RIGHT LOWER CAP</td> <td>1.000</td> <td>PC</td> </tr> <tr> <td>VM3014A0</td> <td></td> <td>1.000</td> <td>PC</td> </tr> <tr> <td>VP1081A0</td> <td>UPPER HINGE CAP FOR UPPER INNER GLASS</td> <td>1.000</td> <td>PC</td> </tr> </tbody> </table>	Code	Description	Qty	UOM	0B1122B0	MM CT 750mm DOOR LOWER BEAM	1.000	PC	VE1030A1	MAGNET FOR DOOR MICROSWITC H D=22.9mm	1.000	PC	VI1074A0	4X16 SCREW FOR PLASTIC	1.000	PC	VI1174A0		8.000	PC	VI1220A1	4.2x12 TCB SELF-TAPPIN G SCREW	1.000	PC	VI1996A0	M5x35 SCREW	6.000	PC	VM1794A0	250x4.8 PA66 BLACK CLAMP	2.000	PC	VM2103A0	CLAMP LOCK	2.000	PC	VM2274A0	GROOVED BUSHING	1.000	PC	VM2305A0	MM SERIES DOOR CAP FIXING PAWL	7.000	PC	VM2384B0	MM LEFT DOOR RIGHT LOWER CAP	1.000	PC	VM3014A0		1.000	PC	VP1081A0	UPPER HINGE CAP FOR UPPER INNER GLASS	1.000	PC
					Code	Description	Qty	UOM																																																					
					0B1122B0	MM CT 750mm DOOR LOWER BEAM	1.000	PC																																																					
					VE1030A1	MAGNET FOR DOOR MICROSWITC H D=22.9mm	1.000	PC																																																					
					VI1074A0	4X16 SCREW FOR PLASTIC	1.000	PC																																																					
					VI1174A0		8.000	PC																																																					
					VI1220A1	4.2x12 TCB SELF-TAPPIN G SCREW	1.000	PC																																																					
					VI1996A0	M5x35 SCREW	6.000	PC																																																					
					VM1794A0	250x4.8 PA66 BLACK CLAMP	2.000	PC																																																					
					VM2103A0	CLAMP LOCK	2.000	PC																																																					
					VM2274A0	GROOVED BUSHING	1.000	PC																																																					
					VM2305A0	MM SERIES DOOR CAP FIXING PAWL	7.000	PC																																																					
					VM2384B0	MM LEFT DOOR RIGHT LOWER CAP	1.000	PC																																																					
VM3014A0		1.000	PC																																																										
VP1081A0	UPPER HINGE CAP FOR UPPER INNER GLASS	1.000	PC																																																										
0B1168A	XEVC-1011-E EXT GLASS SUPPORT PROFILE		0B1168A1	XEVC-1011-E EXT GLASS SUPPORT PROFILE																																																									
0B1216B	MM DOUBLE GLASS DOOR 750mm UPPER BEAM		0B1216B0	MM DOUBLE GLASS DOOR 750mm UPPER BEAM																																																									



COMPONENT			SPARE PART																																		
Code	Description	Image	Code	Description	Kit components																																
0B1217A	MM DOUBLE GLASS DOOR INT UPPER BEAM 750		OUTOFPRODUCTIO	ITEM OUT OF PRODUCTION																																	
VI1930A	5x20 ST. STEEL CHIP SCREW		VI1147A0	5X25 STAINLESS STEEL SCREW																																	
VI1996A	M5x35 SCREW		VI1996A0	M5x35 SCREW																																	
VM2262B	MM -M DOOR RIGHT UPPER CAP		KVM2262B	MIND.MAPS -M DOOR RIGHT UPPER CAP KIT	<table border="1"> <thead> <tr> <th>Code</th> <th>Description</th> <th>Qty</th> <th>UOM</th> </tr> </thead> <tbody> <tr> <td>VE1030A1</td> <td>MAGNET FOR DOOR MICROSWITC H D=22,9mm</td> <td>1.000</td> <td>PC</td> </tr> <tr> <td>VI1220A1</td> <td>4,2x12 TCB SELF-TAPPIN G SCREW</td> <td>1.000</td> <td>PC</td> </tr> <tr> <td>VI1930A1</td> <td>5x20 ST. STEEL CHIP SCREW</td> <td>4.000</td> <td>PC</td> </tr> <tr> <td>VI1996A0</td> <td>M5x35 SCREW</td> <td>4.000</td> <td>PC</td> </tr> <tr> <td>VM2268A0</td> <td>DOOR MAGNET COVER</td> <td>1.000</td> <td>PC</td> </tr> <tr> <td>VM2305A0</td> <td>MM SERIES DOOR CAP FIXING PAWL</td> <td>4.000</td> <td>PC</td> </tr> <tr> <td>VM2956A0</td> <td></td> <td>1.000</td> <td>PC</td> </tr> </tbody> </table>	Code	Description	Qty	UOM	VE1030A1	MAGNET FOR DOOR MICROSWITC H D=22,9mm	1.000	PC	VI1220A1	4,2x12 TCB SELF-TAPPIN G SCREW	1.000	PC	VI1930A1	5x20 ST. STEEL CHIP SCREW	4.000	PC	VI1996A0	M5x35 SCREW	4.000	PC	VM2268A0	DOOR MAGNET COVER	1.000	PC	VM2305A0	MM SERIES DOOR CAP FIXING PAWL	4.000	PC	VM2956A0		1.000	PC
Code	Description	Qty	UOM																																		
VE1030A1	MAGNET FOR DOOR MICROSWITC H D=22,9mm	1.000	PC																																		
VI1220A1	4,2x12 TCB SELF-TAPPIN G SCREW	1.000	PC																																		
VI1930A1	5x20 ST. STEEL CHIP SCREW	4.000	PC																																		
VI1996A0	M5x35 SCREW	4.000	PC																																		
VM2268A0	DOOR MAGNET COVER	1.000	PC																																		
VM2305A0	MM SERIES DOOR CAP FIXING PAWL	4.000	PC																																		
VM2956A0		1.000	PC																																		





COMPONENT			SPARE PART																																		
Code	Description	Image	Code	Description	Kit components																																
VM2267A	INTERNAL GLASS LOCKING SYSTEM SLIDER		KVM2386B	MM -M LEFT DOOR LEFT LOWER CAP KI	<table border="1"> <thead> <tr> <th>Code</th> <th>Description</th> <th>Qty</th> <th>UOM</th> </tr> </thead> <tbody> <tr> <td>VE1030A1</td> <td>MAGNET FOR DOOR MICROSWITC H D=22.9mm</td> <td>1.000</td> <td>PC</td> </tr> <tr> <td>VI1220A1</td> <td>4,2x12 TCB SELF-TAPPIN G SCREW</td> <td>1.000</td> <td>PC</td> </tr> <tr> <td>VI1930A1</td> <td>5x20 ST. STEEL CHIP SCREW</td> <td>4.000</td> <td>PC</td> </tr> <tr> <td>VI1996A0</td> <td>M5x35 SCREW</td> <td>4.000</td> <td>PC</td> </tr> <tr> <td>VM2268A0</td> <td>DOOR MAGNET COVER</td> <td>1.000</td> <td>PC</td> </tr> <tr> <td>VM2305A0</td> <td>MM SERIES DOOR CAP FIXING PAWL</td> <td>4.000</td> <td>PC</td> </tr> <tr> <td>VM2960A0</td> <td></td> <td>1.000</td> <td>PC</td> </tr> </tbody> </table>	Code	Description	Qty	UOM	VE1030A1	MAGNET FOR DOOR MICROSWITC H D=22.9mm	1.000	PC	VI1220A1	4,2x12 TCB SELF-TAPPIN G SCREW	1.000	PC	VI1930A1	5x20 ST. STEEL CHIP SCREW	4.000	PC	VI1996A0	M5x35 SCREW	4.000	PC	VM2268A0	DOOR MAGNET COVER	1.000	PC	VM2305A0	MM SERIES DOOR CAP FIXING PAWL	4.000	PC	VM2960A0		1.000	PC
			Code	Description	Qty	UOM																															
			VE1030A1	MAGNET FOR DOOR MICROSWITC H D=22.9mm	1.000	PC																															
VI1220A1	4,2x12 TCB SELF-TAPPIN G SCREW	1.000	PC																																		
VI1930A1	5x20 ST. STEEL CHIP SCREW	4.000	PC																																		
VI1996A0	M5x35 SCREW	4.000	PC																																		
VM2268A0	DOOR MAGNET COVER	1.000	PC																																		
VM2305A0	MM SERIES DOOR CAP FIXING PAWL	4.000	PC																																		
VM2960A0		1.000	PC																																		
KVM2385B	MM -M LEFT DOOR LEFT UPPER CAP KI	<table border="1"> <thead> <tr> <th>Code</th> <th>Description</th> <th>Qty</th> <th>UOM</th> </tr> </thead> <tbody> <tr> <td>VE1030A1</td> <td>MAGNET FOR DOOR MICROSWITC H D=22.9mm</td> <td>1.000</td> <td>PC</td> </tr> <tr> <td>VI1220A1</td> <td>4,2x12 TCB SELF-TAPPIN G SCREW</td> <td>1.000</td> <td>PC</td> </tr> <tr> <td>VI1930A1</td> <td>5x20 ST. STEEL CHIP SCREW</td> <td>4.000</td> <td>PC</td> </tr> <tr> <td>VI1996A0</td> <td>M5x35 SCREW</td> <td>4.000</td> <td>PC</td> </tr> <tr> <td>VM2268A0</td> <td>DOOR MAGNET COVER</td> <td>1.000</td> <td>PC</td> </tr> <tr> <td>VM2305A0</td> <td>MM SERIES DOOR CAP FIXING PAWL</td> <td>4.000</td> <td>PC</td> </tr> <tr> <td>VM2959A0</td> <td></td> <td>1.000</td> <td>PC</td> </tr> </tbody> </table>	Code	Description	Qty	UOM	VE1030A1	MAGNET FOR DOOR MICROSWITC H D=22.9mm	1.000	PC	VI1220A1	4,2x12 TCB SELF-TAPPIN G SCREW	1.000	PC	VI1930A1	5x20 ST. STEEL CHIP SCREW	4.000	PC	VI1996A0	M5x35 SCREW	4.000	PC	VM2268A0	DOOR MAGNET COVER	1.000	PC	VM2305A0	MM SERIES DOOR CAP FIXING PAWL	4.000	PC	VM2959A0		1.000	PC			
Code	Description	Qty	UOM																																		
VE1030A1	MAGNET FOR DOOR MICROSWITC H D=22.9mm	1.000	PC																																		
VI1220A1	4,2x12 TCB SELF-TAPPIN G SCREW	1.000	PC																																		
VI1930A1	5x20 ST. STEEL CHIP SCREW	4.000	PC																																		
VI1996A0	M5x35 SCREW	4.000	PC																																		
VM2268A0	DOOR MAGNET COVER	1.000	PC																																		
VM2305A0	MM SERIES DOOR CAP FIXING PAWL	4.000	PC																																		
VM2959A0		1.000	PC																																		
KVM2262B	MIND.MAPS -M DOOR RIGHT UPPER CAP KIT	<table border="1"> <thead> <tr> <th>Code</th> <th>Description</th> <th>Qty</th> <th>UOM</th> </tr> </thead> <tbody> <tr> <td>VE1030A1</td> <td>MAGNET FOR DOOR MICROSWITC H D=22.9mm</td> <td>1.000</td> <td>PC</td> </tr> <tr> <td>VI1220A1</td> <td>4,2x12 TCB SELF-TAPPIN G SCREW</td> <td>1.000</td> <td>PC</td> </tr> <tr> <td>VI1930A1</td> <td>5x20 ST. STEEL CHIP SCREW</td> <td>4.000</td> <td>PC</td> </tr> <tr> <td>VI1996A0</td> <td>M5x35 SCREW</td> <td>4.000</td> <td>PC</td> </tr> <tr> <td>VM2268A0</td> <td>DOOR MAGNET COVER</td> <td>1.000</td> <td>PC</td> </tr> </tbody> </table>	Code	Description	Qty	UOM	VE1030A1	MAGNET FOR DOOR MICROSWITC H D=22.9mm	1.000	PC	VI1220A1	4,2x12 TCB SELF-TAPPIN G SCREW	1.000	PC	VI1930A1	5x20 ST. STEEL CHIP SCREW	4.000	PC	VI1996A0	M5x35 SCREW	4.000	PC	VM2268A0	DOOR MAGNET COVER	1.000	PC											
Code	Description	Qty	UOM																																		
VE1030A1	MAGNET FOR DOOR MICROSWITC H D=22.9mm	1.000	PC																																		
VI1220A1	4,2x12 TCB SELF-TAPPIN G SCREW	1.000	PC																																		
VI1930A1	5x20 ST. STEEL CHIP SCREW	4.000	PC																																		
VI1996A0	M5x35 SCREW	4.000	PC																																		
VM2268A0	DOOR MAGNET COVER	1.000	PC																																		

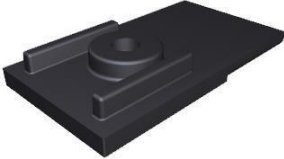

COMPONENT			SPARE PART																																		
Code	Description	Image	Code	Description	Kit components																																
VM2267A	INTERNAL GLASS LOCKING SYSTEM SLIDER		KVM2262B	MIND.MAPS -M DOOR RIGHT UPPER CAP KIT	<table border="1"> <thead> <tr> <th>Code</th> <th>Description</th> <th>Qty</th> <th>UOM</th> </tr> </thead> <tbody> <tr> <td>VM2305A0</td> <td>MM SERIES DOOR CAP FIXING PAWL</td> <td>4.000</td> <td>PC</td> </tr> <tr> <td>VM2956A0</td> <td></td> <td>1.000</td> <td>PC</td> </tr> </tbody> </table>	Code	Description	Qty	UOM	VM2305A0	MM SERIES DOOR CAP FIXING PAWL	4.000	PC	VM2956A0		1.000	PC																				
			Code	Description	Qty	UOM																															
VM2305A0	MM SERIES DOOR CAP FIXING PAWL	4.000	PC																																		
VM2956A0		1.000	PC																																		
KVM2261B	MIND.MAPS -M DOOR RIGHT LOWER CAP KIT	<table border="1"> <thead> <tr> <th>Code</th> <th>Description</th> <th>Qty</th> <th>UOM</th> </tr> </thead> <tbody> <tr> <td>VE1030A1</td> <td>MAGNET FOR DOOR MICROSWITC H D=22,9mm</td> <td>1.000</td> <td>PC</td> </tr> <tr> <td>VI1220A1</td> <td>4,2x12 TCB SELF-TAPPIN G SCREW</td> <td>1.000</td> <td>PC</td> </tr> <tr> <td>VI1930A1</td> <td>5x20 ST. STEEL CHIP SCREW</td> <td>4.000</td> <td>PC</td> </tr> <tr> <td>VI1996A0</td> <td>M5x35 SCREW</td> <td>4.000</td> <td>PC</td> </tr> <tr> <td>VM2268A0</td> <td>DOOR MAGNET COVER</td> <td>1.000</td> <td>PC</td> </tr> <tr> <td>VM2305A0</td> <td>MM SERIES DOOR CAP FIXING PAWL</td> <td>4.000</td> <td>PC</td> </tr> <tr> <td>VM2957A0</td> <td></td> <td>1.000</td> <td>PC</td> </tr> </tbody> </table>	Code	Description	Qty	UOM	VE1030A1	MAGNET FOR DOOR MICROSWITC H D=22,9mm	1.000	PC	VI1220A1	4,2x12 TCB SELF-TAPPIN G SCREW	1.000	PC	VI1930A1	5x20 ST. STEEL CHIP SCREW	4.000	PC	VI1996A0	M5x35 SCREW	4.000	PC	VM2268A0	DOOR MAGNET COVER	1.000	PC	VM2305A0	MM SERIES DOOR CAP FIXING PAWL	4.000	PC	VM2957A0		1.000	PC			
Code	Description	Qty	UOM																																		
VE1030A1	MAGNET FOR DOOR MICROSWITC H D=22,9mm	1.000	PC																																		
VI1220A1	4,2x12 TCB SELF-TAPPIN G SCREW	1.000	PC																																		
VI1930A1	5x20 ST. STEEL CHIP SCREW	4.000	PC																																		
VI1996A0	M5x35 SCREW	4.000	PC																																		
VM2268A0	DOOR MAGNET COVER	1.000	PC																																		
VM2305A0	MM SERIES DOOR CAP FIXING PAWL	4.000	PC																																		
VM2957A0		1.000	PC																																		
VM2269B	INNER GLASS FIXING CAP		KVM2386B	MM -M LEFT DOOR LEFT LOWER CAP KI	<table border="1"> <thead> <tr> <th>Code</th> <th>Description</th> <th>Qty</th> <th>UOM</th> </tr> </thead> <tbody> <tr> <td>VE1030A1</td> <td>MAGNET FOR DOOR MICROSWITC H D=22,9mm</td> <td>1.000</td> <td>PC</td> </tr> <tr> <td>VI1220A1</td> <td>4,2x12 TCB SELF-TAPPIN G SCREW</td> <td>1.000</td> <td>PC</td> </tr> <tr> <td>VI1930A1</td> <td>5x20 ST. STEEL CHIP SCREW</td> <td>4.000</td> <td>PC</td> </tr> <tr> <td>VI1996A0</td> <td>M5x35 SCREW</td> <td>4.000</td> <td>PC</td> </tr> <tr> <td>VM2268A0</td> <td>DOOR MAGNET COVER</td> <td>1.000</td> <td>PC</td> </tr> <tr> <td>VM2305A0</td> <td>MM SERIES DOOR CAP FIXING PAWL</td> <td>4.000</td> <td>PC</td> </tr> <tr> <td>VM2960A0</td> <td></td> <td>1.000</td> <td>PC</td> </tr> </tbody> </table>	Code	Description	Qty	UOM	VE1030A1	MAGNET FOR DOOR MICROSWITC H D=22,9mm	1.000	PC	VI1220A1	4,2x12 TCB SELF-TAPPIN G SCREW	1.000	PC	VI1930A1	5x20 ST. STEEL CHIP SCREW	4.000	PC	VI1996A0	M5x35 SCREW	4.000	PC	VM2268A0	DOOR MAGNET COVER	1.000	PC	VM2305A0	MM SERIES DOOR CAP FIXING PAWL	4.000	PC	VM2960A0		1.000	PC
			Code	Description	Qty	UOM																															
VE1030A1	MAGNET FOR DOOR MICROSWITC H D=22,9mm	1.000	PC																																		
VI1220A1	4,2x12 TCB SELF-TAPPIN G SCREW	1.000	PC																																		
VI1930A1	5x20 ST. STEEL CHIP SCREW	4.000	PC																																		
VI1996A0	M5x35 SCREW	4.000	PC																																		
VM2268A0	DOOR MAGNET COVER	1.000	PC																																		
VM2305A0	MM SERIES DOOR CAP FIXING PAWL	4.000	PC																																		
VM2960A0		1.000	PC																																		
KVM2385B	MM -M LEFT DOOR LEFT UPPER CAP KI	<table border="1"> <thead> <tr> <th>Code</th> <th>Description</th> <th>Qty</th> <th>UOM</th> </tr> </thead> <tbody> <tr> <td>VE1030A1</td> <td>MAGNET FOR DOOR MICROSWITC H D=22,9mm</td> <td>1.000</td> <td>PC</td> </tr> <tr> <td>VI1220A1</td> <td>4,2x12 TCB SELF-TAPPIN G SCREW</td> <td>1.000</td> <td>PC</td> </tr> </tbody> </table>	Code	Description	Qty	UOM	VE1030A1	MAGNET FOR DOOR MICROSWITC H D=22,9mm	1.000	PC	VI1220A1	4,2x12 TCB SELF-TAPPIN G SCREW	1.000	PC																							
Code	Description	Qty	UOM																																		
VE1030A1	MAGNET FOR DOOR MICROSWITC H D=22,9mm	1.000	PC																																		
VI1220A1	4,2x12 TCB SELF-TAPPIN G SCREW	1.000	PC																																		

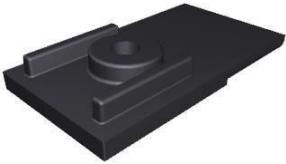

COMPONENT			SPARE PART																															
Code	Description	Image	Code	Description	Kit components																													
VM2269B	INNER GLASS FIXING CAP		KVM2385B	MM -M LEFT DOOR LEFT UPPER CAP KI	<table border="1"> <thead> <tr> <th>Code</th> <th>Description</th> <th>Qty</th> <th>UOM</th> </tr> </thead> <tbody> <tr> <td>VI1930A1</td> <td>5x20 ST. STEEL CHIP SCREW</td> <td>4.000</td> <td>PC</td> </tr> <tr> <td>VI1996A0</td> <td>M5x35 SCREW</td> <td>4.000</td> <td>PC</td> </tr> <tr> <td>VM2268A0</td> <td>DOOR MAGNET COVER</td> <td>1.000</td> <td>PC</td> </tr> <tr> <td>VM2305A0</td> <td>MM SERIES DOOR CAP FIXING PAWL</td> <td>4.000</td> <td>PC</td> </tr> <tr> <td>VM2959A0</td> <td></td> <td>1.000</td> <td>PC</td> </tr> </tbody> </table>	Code	Description	Qty	UOM	VI1930A1	5x20 ST. STEEL CHIP SCREW	4.000	PC	VI1996A0	M5x35 SCREW	4.000	PC	VM2268A0	DOOR MAGNET COVER	1.000	PC	VM2305A0	MM SERIES DOOR CAP FIXING PAWL	4.000	PC	VM2959A0		1.000	PC					
			Code	Description	Qty	UOM																												
			VI1930A1	5x20 ST. STEEL CHIP SCREW	4.000	PC																												
VI1996A0	M5x35 SCREW	4.000	PC																															
VM2268A0	DOOR MAGNET COVER	1.000	PC																															
VM2305A0	MM SERIES DOOR CAP FIXING PAWL	4.000	PC																															
VM2959A0		1.000	PC																															
KVM2262B	MIND.MAPS -M DOOR RIGHT UPPER CAP KIT	<table border="1"> <thead> <tr> <th>Code</th> <th>Description</th> <th>Qty</th> <th>UOM</th> </tr> </thead> <tbody> <tr> <td>VE1030A1</td> <td>MAGNET FOR DOOR MICROSWITC H D=22,9mm</td> <td>1.000</td> <td>PC</td> </tr> <tr> <td>VI1220A1</td> <td>4,2x12 TCB SELF-TAPPIN G SCREW</td> <td>1.000</td> <td>PC</td> </tr> <tr> <td>VI1930A1</td> <td>5x20 ST. STEEL CHIP SCREW</td> <td>4.000</td> <td>PC</td> </tr> <tr> <td>VI1996A0</td> <td>M5x35 SCREW</td> <td>4.000</td> <td>PC</td> </tr> <tr> <td>VM2268A0</td> <td>DOOR MAGNET COVER</td> <td>1.000</td> <td>PC</td> </tr> <tr> <td>VM2305A0</td> <td>MM SERIES DOOR CAP FIXING PAWL</td> <td>4.000</td> <td>PC</td> </tr> <tr> <td>VM2956A0</td> <td></td> <td>1.000</td> <td>PC</td> </tr> </tbody> </table>	Code	Description	Qty	UOM	VE1030A1	MAGNET FOR DOOR MICROSWITC H D=22,9mm	1.000	PC	VI1220A1	4,2x12 TCB SELF-TAPPIN G SCREW	1.000	PC	VI1930A1	5x20 ST. STEEL CHIP SCREW	4.000	PC	VI1996A0	M5x35 SCREW	4.000	PC	VM2268A0	DOOR MAGNET COVER	1.000	PC	VM2305A0	MM SERIES DOOR CAP FIXING PAWL	4.000	PC	VM2956A0		1.000	PC
Code	Description	Qty	UOM																															
VE1030A1	MAGNET FOR DOOR MICROSWITC H D=22,9mm	1.000	PC																															
VI1220A1	4,2x12 TCB SELF-TAPPIN G SCREW	1.000	PC																															
VI1930A1	5x20 ST. STEEL CHIP SCREW	4.000	PC																															
VI1996A0	M5x35 SCREW	4.000	PC																															
VM2268A0	DOOR MAGNET COVER	1.000	PC																															
VM2305A0	MM SERIES DOOR CAP FIXING PAWL	4.000	PC																															
VM2956A0		1.000	PC																															
KVM2261B	MIND.MAPS -M DOOR RIGHT LOWER CAP KIT	<table border="1"> <thead> <tr> <th>Code</th> <th>Description</th> <th>Qty</th> <th>UOM</th> </tr> </thead> <tbody> <tr> <td>VE1030A1</td> <td>MAGNET FOR DOOR MICROSWITC H D=22,9mm</td> <td>1.000</td> <td>PC</td> </tr> <tr> <td>VI1220A1</td> <td>4,2x12 TCB SELF-TAPPIN G SCREW</td> <td>1.000</td> <td>PC</td> </tr> <tr> <td>VI1930A1</td> <td>5x20 ST. STEEL CHIP SCREW</td> <td>4.000</td> <td>PC</td> </tr> <tr> <td>VI1996A0</td> <td>M5x35 SCREW</td> <td>4.000</td> <td>PC</td> </tr> <tr> <td>VM2268A0</td> <td>DOOR MAGNET COVER</td> <td>1.000</td> <td>PC</td> </tr> <tr> <td>VM2305A0</td> <td>MM SERIES DOOR CAP FIXING PAWL</td> <td>4.000</td> <td>PC</td> </tr> <tr> <td>VM2957A0</td> <td></td> <td>1.000</td> <td>PC</td> </tr> </tbody> </table>	Code	Description	Qty	UOM	VE1030A1	MAGNET FOR DOOR MICROSWITC H D=22,9mm	1.000	PC	VI1220A1	4,2x12 TCB SELF-TAPPIN G SCREW	1.000	PC	VI1930A1	5x20 ST. STEEL CHIP SCREW	4.000	PC	VI1996A0	M5x35 SCREW	4.000	PC	VM2268A0	DOOR MAGNET COVER	1.000	PC	VM2305A0	MM SERIES DOOR CAP FIXING PAWL	4.000	PC	VM2957A0		1.000	PC
Code	Description	Qty	UOM																															
VE1030A1	MAGNET FOR DOOR MICROSWITC H D=22,9mm	1.000	PC																															
VI1220A1	4,2x12 TCB SELF-TAPPIN G SCREW	1.000	PC																															
VI1930A1	5x20 ST. STEEL CHIP SCREW	4.000	PC																															
VI1996A0	M5x35 SCREW	4.000	PC																															
VM2268A0	DOOR MAGNET COVER	1.000	PC																															
VM2305A0	MM SERIES DOOR CAP FIXING PAWL	4.000	PC																															
VM2957A0		1.000	PC																															

COMPONENT			SPARE PART																																						
Code	Description	Image	Code	Description	Kit components																																				
VM2305A	MM SERIES DOOR CAP FIXING PAWL		KVM2305A	MM FIXING DOOR THUB SCREWS 10 PCS KIT	<table border="1"> <thead> <tr> <th>Code</th> <th>Description</th> <th>Qty</th> <th>UOM</th> </tr> </thead> <tbody> <tr> <td>VM2305A0</td> <td>MM SERIES DOOR CAP FIXING PAWL</td> <td>10.000</td> <td>PC</td> </tr> </tbody> </table>	Code	Description	Qty	UOM	VM2305A0	MM SERIES DOOR CAP FIXING PAWL	10.000	PC																												
Code	Description	Qty	UOM																																						
VM2305A0	MM SERIES DOOR CAP FIXING PAWL	10.000	PC																																						
VE1030A	MAGNET FOR DOOR MICROSWITCH D=22,9mm		KVE1030A	2 PCS MAGNET KIT FOR DOOR SWITCH	<table border="1"> <thead> <tr> <th>Code</th> <th>Description</th> <th>Qty</th> <th>UOM</th> </tr> </thead> <tbody> <tr> <td>VE1030A1</td> <td>MAGNET FOR DOOR MICROSWITCH H D=22,9mm</td> <td>2.000</td> <td>PC</td> </tr> <tr> <td>VI1220A1</td> <td>4,2x12 TCB SELF-TAPPING SCREW</td> <td>1.000</td> <td>PC</td> </tr> </tbody> </table>	Code	Description	Qty	UOM	VE1030A1	MAGNET FOR DOOR MICROSWITCH H D=22,9mm	2.000	PC	VI1220A1	4,2x12 TCB SELF-TAPPING SCREW	1.000	PC																								
Code	Description	Qty	UOM																																						
VE1030A1	MAGNET FOR DOOR MICROSWITCH H D=22,9mm	2.000	PC																																						
VI1220A1	4,2x12 TCB SELF-TAPPING SCREW	1.000	PC																																						
			KVE1020B	MICROSWITCH KIT	<table border="1"> <thead> <tr> <th>Code</th> <th>Description</th> <th>Qty</th> <th>UOM</th> </tr> </thead> <tbody> <tr> <td>CE1030A0</td> <td>FEMALE FASTON COVER 6.3X0.8 0,5-1mmg</td> <td>2.000</td> <td>PC</td> </tr> <tr> <td>CE1660A0</td> <td>6,3x0,8 FEMALE FASTON COVE</td> <td>2.000</td> <td>PC</td> </tr> <tr> <td>CE1730A0</td> <td>PVC CABLE NP 2 X AWG22 STYLE 2095</td> <td>0.150</td> <td>M</td> </tr> <tr> <td>CE1740A0</td> <td>MINIFIT MALE END FITTING</td> <td>2.000</td> <td>PC</td> </tr> <tr> <td>CE1745A0</td> <td>2 WAYS FEMALE MINIFIT CONNECTOR</td> <td>1.000</td> <td>PC</td> </tr> <tr> <td>VE1020B0</td> <td>MAGNET DOOR MICROSWITCH</td> <td>1.000</td> <td>PC</td> </tr> <tr> <td>VE1030A1</td> <td>MAGNET FOR DOOR MICROSWITCH H D=22,9mm</td> <td>1.000</td> <td>PC</td> </tr> <tr> <td>VI1192A0</td> <td></td> <td>1.000</td> <td>PC</td> </tr> </tbody> </table>	Code	Description	Qty	UOM	CE1030A0	FEMALE FASTON COVER 6.3X0.8 0,5-1mmg	2.000	PC	CE1660A0	6,3x0,8 FEMALE FASTON COVE	2.000	PC	CE1730A0	PVC CABLE NP 2 X AWG22 STYLE 2095	0.150	M	CE1740A0	MINIFIT MALE END FITTING	2.000	PC	CE1745A0	2 WAYS FEMALE MINIFIT CONNECTOR	1.000	PC	VE1020B0	MAGNET DOOR MICROSWITCH	1.000	PC	VE1030A1	MAGNET FOR DOOR MICROSWITCH H D=22,9mm	1.000	PC	VI1192A0		1.000	PC
Code	Description	Qty	UOM																																						
CE1030A0	FEMALE FASTON COVER 6.3X0.8 0,5-1mmg	2.000	PC																																						
CE1660A0	6,3x0,8 FEMALE FASTON COVE	2.000	PC																																						
CE1730A0	PVC CABLE NP 2 X AWG22 STYLE 2095	0.150	M																																						
CE1740A0	MINIFIT MALE END FITTING	2.000	PC																																						
CE1745A0	2 WAYS FEMALE MINIFIT CONNECTOR	1.000	PC																																						
VE1020B0	MAGNET DOOR MICROSWITCH	1.000	PC																																						
VE1030A1	MAGNET FOR DOOR MICROSWITCH H D=22,9mm	1.000	PC																																						
VI1192A0		1.000	PC																																						
VI1930A	5x20 ST. STEEL CHIP SCREW		VI1147A0	5X25 STAINLESS STEEL SCREW																																					





COMPONENT			SPARE PART																																		
Code	Description	Image	Code	Description	Kit components																																
VI1996A	M5x35 SCREW		VI1996A0	M5x35 SCREW																																	
VM2261B	MM -M DOOR RIGHT LOWER CAP		KVM2261B	MIND.MAPS -M DOOR RIGHT LOWER CAP KIT	<table border="1"> <thead> <tr> <th>Code</th> <th>Description</th> <th>Qty</th> <th>UOM</th> </tr> </thead> <tbody> <tr> <td>VE1030A1</td> <td>MAGNET FOR DOOR MICROSWITC H D=22,9mm</td> <td>1.000</td> <td>PC</td> </tr> <tr> <td>VI1220A1</td> <td>4,2x12 TCB SELF-TAPPIN G SCREW</td> <td>1.000</td> <td>PC</td> </tr> <tr> <td>VI1930A1</td> <td>5x20 ST. STEEL CHIP SCREW</td> <td>4.000</td> <td>PC</td> </tr> <tr> <td>VI1996A0</td> <td>M5x35 SCREW</td> <td>4.000</td> <td>PC</td> </tr> <tr> <td>VM2268A0</td> <td>DOOR MAGNET COVER</td> <td>1.000</td> <td>PC</td> </tr> <tr> <td>VM2305A0</td> <td>MM SERIES DOOR CAP FIXING PAWL</td> <td>4.000</td> <td>PC</td> </tr> <tr> <td>VM2957A0</td> <td></td> <td>1.000</td> <td>PC</td> </tr> </tbody> </table>	Code	Description	Qty	UOM	VE1030A1	MAGNET FOR DOOR MICROSWITC H D=22,9mm	1.000	PC	VI1220A1	4,2x12 TCB SELF-TAPPIN G SCREW	1.000	PC	VI1930A1	5x20 ST. STEEL CHIP SCREW	4.000	PC	VI1996A0	M5x35 SCREW	4.000	PC	VM2268A0	DOOR MAGNET COVER	1.000	PC	VM2305A0	MM SERIES DOOR CAP FIXING PAWL	4.000	PC	VM2957A0		1.000	PC
Code	Description	Qty	UOM																																		
VE1030A1	MAGNET FOR DOOR MICROSWITC H D=22,9mm	1.000	PC																																		
VI1220A1	4,2x12 TCB SELF-TAPPIN G SCREW	1.000	PC																																		
VI1930A1	5x20 ST. STEEL CHIP SCREW	4.000	PC																																		
VI1996A0	M5x35 SCREW	4.000	PC																																		
VM2268A0	DOOR MAGNET COVER	1.000	PC																																		
VM2305A0	MM SERIES DOOR CAP FIXING PAWL	4.000	PC																																		
VM2957A0		1.000	PC																																		
VM2267A	INTERNAL GLASS LOCKING SYSTEM SLIDER		KVM2386B	MM -M LEFT DOOR LEFT LOWER CAP KI	<table border="1"> <thead> <tr> <th>Code</th> <th>Description</th> <th>Qty</th> <th>UOM</th> </tr> </thead> <tbody> <tr> <td>VE1030A1</td> <td>MAGNET FOR DOOR MICROSWITC H D=22,9mm</td> <td>1.000</td> <td>PC</td> </tr> <tr> <td>VI1220A1</td> <td>4,2x12 TCB SELF-TAPPIN G SCREW</td> <td>1.000</td> <td>PC</td> </tr> <tr> <td>VI1930A1</td> <td>5x20 ST. STEEL CHIP SCREW</td> <td>4.000</td> <td>PC</td> </tr> <tr> <td>VI1996A0</td> <td>M5x35 SCREW</td> <td>4.000</td> <td>PC</td> </tr> <tr> <td>VM2268A0</td> <td>DOOR MAGNET COVER</td> <td>1.000</td> <td>PC</td> </tr> <tr> <td>VM2305A0</td> <td>MM SERIES DOOR CAP FIXING PAWL</td> <td>4.000</td> <td>PC</td> </tr> <tr> <td>VM2960A0</td> <td></td> <td>1.000</td> <td>PC</td> </tr> </tbody> </table>	Code	Description	Qty	UOM	VE1030A1	MAGNET FOR DOOR MICROSWITC H D=22,9mm	1.000	PC	VI1220A1	4,2x12 TCB SELF-TAPPIN G SCREW	1.000	PC	VI1930A1	5x20 ST. STEEL CHIP SCREW	4.000	PC	VI1996A0	M5x35 SCREW	4.000	PC	VM2268A0	DOOR MAGNET COVER	1.000	PC	VM2305A0	MM SERIES DOOR CAP FIXING PAWL	4.000	PC	VM2960A0		1.000	PC
Code	Description	Qty	UOM																																		
VE1030A1	MAGNET FOR DOOR MICROSWITC H D=22,9mm	1.000	PC																																		
VI1220A1	4,2x12 TCB SELF-TAPPIN G SCREW	1.000	PC																																		
VI1930A1	5x20 ST. STEEL CHIP SCREW	4.000	PC																																		
VI1996A0	M5x35 SCREW	4.000	PC																																		
VM2268A0	DOOR MAGNET COVER	1.000	PC																																		
VM2305A0	MM SERIES DOOR CAP FIXING PAWL	4.000	PC																																		
VM2960A0		1.000	PC																																		
			KVM2385B	MM -M LEFT DOOR LEFT UPPER CAP KI	<table border="1"> <thead> <tr> <th>Code</th> <th>Description</th> <th>Qty</th> <th>UOM</th> </tr> </thead> <tbody> <tr> <td>VE1030A1</td> <td>MAGNET FOR DOOR MICROSWITC H D=22,9mm</td> <td>1.000</td> <td>PC</td> </tr> </tbody> </table>	Code	Description	Qty	UOM	VE1030A1	MAGNET FOR DOOR MICROSWITC H D=22,9mm	1.000	PC																								
Code	Description	Qty	UOM																																		
VE1030A1	MAGNET FOR DOOR MICROSWITC H D=22,9mm	1.000	PC																																		



COMPONENT			SPARE PART																																		
Code	Description	Image	Code	Description	Kit components																																
VM2267A	INTERNAL GLASS LOCKING SYSTEM SLIDER		KVM2385B	MM -M LEFT DOOR LEFT UPPER CAP KI	<table border="1"> <thead> <tr> <th>Code</th> <th>Description</th> <th>Qty</th> <th>UOM</th> </tr> </thead> <tbody> <tr> <td>VI1220A1</td> <td>4,2x12 TCB SELF-TAPPIN G SCREW</td> <td>1.000</td> <td>PC</td> </tr> <tr> <td>VI1930A1</td> <td>5x20 ST. STEEL CHIP SCREW</td> <td>4.000</td> <td>PC</td> </tr> <tr> <td>VI1996A0</td> <td>M5x35 SCREW</td> <td>4.000</td> <td>PC</td> </tr> <tr> <td>VM2268A0</td> <td>DOOR MAGNET COVER</td> <td>1.000</td> <td>PC</td> </tr> <tr> <td>VM2305A0</td> <td>MM SERIES DOOR CAP FIXING PAWL</td> <td>4.000</td> <td>PC</td> </tr> <tr> <td>VM2959A0</td> <td></td> <td>1.000</td> <td>PC</td> </tr> </tbody> </table>	Code	Description	Qty	UOM	VI1220A1	4,2x12 TCB SELF-TAPPIN G SCREW	1.000	PC	VI1930A1	5x20 ST. STEEL CHIP SCREW	4.000	PC	VI1996A0	M5x35 SCREW	4.000	PC	VM2268A0	DOOR MAGNET COVER	1.000	PC	VM2305A0	MM SERIES DOOR CAP FIXING PAWL	4.000	PC	VM2959A0		1.000	PC				
			Code	Description	Qty	UOM																															
			VI1220A1	4,2x12 TCB SELF-TAPPIN G SCREW	1.000	PC																															
			VI1930A1	5x20 ST. STEEL CHIP SCREW	4.000	PC																															
			VI1996A0	M5x35 SCREW	4.000	PC																															
			VM2268A0	DOOR MAGNET COVER	1.000	PC																															
			VM2305A0	MM SERIES DOOR CAP FIXING PAWL	4.000	PC																															
			VM2959A0		1.000	PC																															
			KVM2262B	MIND.MAPS -M DOOR RIGHT UPPER CAP KIT	<table border="1"> <thead> <tr> <th>Code</th> <th>Description</th> <th>Qty</th> <th>UOM</th> </tr> </thead> <tbody> <tr> <td>VE1030A1</td> <td>MAGNET FOR DOOR MICROSWITC H D=22,9mm</td> <td>1.000</td> <td>PC</td> </tr> <tr> <td>VI1220A1</td> <td>4,2x12 TCB SELF-TAPPIN G SCREW</td> <td>1.000</td> <td>PC</td> </tr> <tr> <td>VI1930A1</td> <td>5x20 ST. STEEL CHIP SCREW</td> <td>4.000</td> <td>PC</td> </tr> <tr> <td>VI1996A0</td> <td>M5x35 SCREW</td> <td>4.000</td> <td>PC</td> </tr> <tr> <td>VM2268A0</td> <td>DOOR MAGNET COVER</td> <td>1.000</td> <td>PC</td> </tr> <tr> <td>VM2305A0</td> <td>MM SERIES DOOR CAP FIXING PAWL</td> <td>4.000</td> <td>PC</td> </tr> <tr> <td>VM2956A0</td> <td></td> <td>1.000</td> <td>PC</td> </tr> </tbody> </table>	Code	Description	Qty	UOM	VE1030A1	MAGNET FOR DOOR MICROSWITC H D=22,9mm	1.000	PC	VI1220A1	4,2x12 TCB SELF-TAPPIN G SCREW	1.000	PC	VI1930A1	5x20 ST. STEEL CHIP SCREW	4.000	PC	VI1996A0	M5x35 SCREW	4.000	PC	VM2268A0	DOOR MAGNET COVER	1.000	PC	VM2305A0	MM SERIES DOOR CAP FIXING PAWL	4.000	PC	VM2956A0		1.000	PC
			Code	Description	Qty	UOM																															
			VE1030A1	MAGNET FOR DOOR MICROSWITC H D=22,9mm	1.000	PC																															
			VI1220A1	4,2x12 TCB SELF-TAPPIN G SCREW	1.000	PC																															
VI1930A1	5x20 ST. STEEL CHIP SCREW	4.000	PC																																		
VI1996A0	M5x35 SCREW	4.000	PC																																		
VM2268A0	DOOR MAGNET COVER	1.000	PC																																		
VM2305A0	MM SERIES DOOR CAP FIXING PAWL	4.000	PC																																		
VM2956A0		1.000	PC																																		
KVM2261B	MIND.MAPS -M DOOR RIGHT LOWER CAP KIT	<table border="1"> <thead> <tr> <th>Code</th> <th>Description</th> <th>Qty</th> <th>UOM</th> </tr> </thead> <tbody> <tr> <td>VE1030A1</td> <td>MAGNET FOR DOOR MICROSWITC H D=22,9mm</td> <td>1.000</td> <td>PC</td> </tr> <tr> <td>VI1220A1</td> <td>4,2x12 TCB SELF-TAPPIN G SCREW</td> <td>1.000</td> <td>PC</td> </tr> <tr> <td>VI1930A1</td> <td>5x20 ST. STEEL CHIP SCREW</td> <td>4.000</td> <td>PC</td> </tr> <tr> <td>VI1996A0</td> <td>M5x35 SCREW</td> <td>4.000</td> <td>PC</td> </tr> <tr> <td>VM2268A0</td> <td>DOOR MAGNET COVER</td> <td>1.000</td> <td>PC</td> </tr> <tr> <td>VM2305A0</td> <td>MM SERIES DOOR CAP FIXING PAWL</td> <td>4.000</td> <td>PC</td> </tr> <tr> <td>VM2957A0</td> <td></td> <td>1.000</td> <td>PC</td> </tr> </tbody> </table>	Code	Description	Qty	UOM	VE1030A1	MAGNET FOR DOOR MICROSWITC H D=22,9mm	1.000	PC	VI1220A1	4,2x12 TCB SELF-TAPPIN G SCREW	1.000	PC	VI1930A1	5x20 ST. STEEL CHIP SCREW	4.000	PC	VI1996A0	M5x35 SCREW	4.000	PC	VM2268A0	DOOR MAGNET COVER	1.000	PC	VM2305A0	MM SERIES DOOR CAP FIXING PAWL	4.000	PC	VM2957A0		1.000	PC			
Code	Description	Qty	UOM																																		
VE1030A1	MAGNET FOR DOOR MICROSWITC H D=22,9mm	1.000	PC																																		
VI1220A1	4,2x12 TCB SELF-TAPPIN G SCREW	1.000	PC																																		
VI1930A1	5x20 ST. STEEL CHIP SCREW	4.000	PC																																		
VI1996A0	M5x35 SCREW	4.000	PC																																		
VM2268A0	DOOR MAGNET COVER	1.000	PC																																		
VM2305A0	MM SERIES DOOR CAP FIXING PAWL	4.000	PC																																		
VM2957A0		1.000	PC																																		

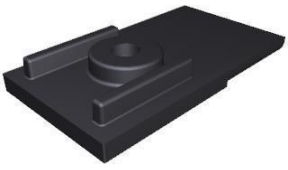

COMPONENT			SPARE PART																																		
Code	Description	Image	Code	Description	Kit components																																
VM2268A	DOOR MAGNET COVER		KVM2268A	DOOR MAGNET COVER KIT	<table border="1"> <thead> <tr> <th>Code</th> <th>Description</th> <th>Qty</th> <th>UOM</th> </tr> </thead> <tbody> <tr> <td>VM2268A0</td> <td>DOOR MAGNET COVER</td> <td>1.000</td> <td>PC</td> </tr> </tbody> </table>	Code	Description	Qty	UOM	VM2268A0	DOOR MAGNET COVER	1.000	PC																								
Code	Description	Qty	UOM																																		
VM2268A0	DOOR MAGNET COVER	1.000	PC																																		
VM2269B	INNER GLASS FIXING CAP		KVM2386B	MM -M LEFT DOOR LEFT LOWER CAP KI	<table border="1"> <thead> <tr> <th>Code</th> <th>Description</th> <th>Qty</th> <th>UOM</th> </tr> </thead> <tbody> <tr> <td>VE1030A1</td> <td>MAGNET FOR DOOR MICROSWITC H D=22,9mm</td> <td>1.000</td> <td>PC</td> </tr> <tr> <td>VI1220A1</td> <td>4,2x12 TCB SELF-TAPPIN G SCREW</td> <td>1.000</td> <td>PC</td> </tr> <tr> <td>VI1930A1</td> <td>5x20 ST. STEEL CHIP SCREW</td> <td>4.000</td> <td>PC</td> </tr> <tr> <td>VI1996A0</td> <td>M5x35 SCREW</td> <td>4.000</td> <td>PC</td> </tr> <tr> <td>VM2268A0</td> <td>DOOR MAGNET COVER</td> <td>1.000</td> <td>PC</td> </tr> <tr> <td>VM2305A0</td> <td>MM SERIES DOOR CAP FIXING PAWL</td> <td>4.000</td> <td>PC</td> </tr> <tr> <td>VM2960A0</td> <td></td> <td>1.000</td> <td>PC</td> </tr> </tbody> </table>	Code	Description	Qty	UOM	VE1030A1	MAGNET FOR DOOR MICROSWITC H D=22,9mm	1.000	PC	VI1220A1	4,2x12 TCB SELF-TAPPIN G SCREW	1.000	PC	VI1930A1	5x20 ST. STEEL CHIP SCREW	4.000	PC	VI1996A0	M5x35 SCREW	4.000	PC	VM2268A0	DOOR MAGNET COVER	1.000	PC	VM2305A0	MM SERIES DOOR CAP FIXING PAWL	4.000	PC	VM2960A0		1.000	PC
			Code	Description	Qty	UOM																															
			VE1030A1	MAGNET FOR DOOR MICROSWITC H D=22,9mm	1.000	PC																															
VI1220A1	4,2x12 TCB SELF-TAPPIN G SCREW	1.000	PC																																		
VI1930A1	5x20 ST. STEEL CHIP SCREW	4.000	PC																																		
VI1996A0	M5x35 SCREW	4.000	PC																																		
VM2268A0	DOOR MAGNET COVER	1.000	PC																																		
VM2305A0	MM SERIES DOOR CAP FIXING PAWL	4.000	PC																																		
VM2960A0		1.000	PC																																		
KVM2385B	MM -M LEFT DOOR LEFT UPPER CAP KI	<table border="1"> <thead> <tr> <th>Code</th> <th>Description</th> <th>Qty</th> <th>UOM</th> </tr> </thead> <tbody> <tr> <td>VE1030A1</td> <td>MAGNET FOR DOOR MICROSWITC H D=22,9mm</td> <td>1.000</td> <td>PC</td> </tr> <tr> <td>VI1220A1</td> <td>4,2x12 TCB SELF-TAPPIN G SCREW</td> <td>1.000</td> <td>PC</td> </tr> <tr> <td>VI1930A1</td> <td>5x20 ST. STEEL CHIP SCREW</td> <td>4.000</td> <td>PC</td> </tr> <tr> <td>VI1996A0</td> <td>M5x35 SCREW</td> <td>4.000</td> <td>PC</td> </tr> <tr> <td>VM2268A0</td> <td>DOOR MAGNET COVER</td> <td>1.000</td> <td>PC</td> </tr> <tr> <td>VM2305A0</td> <td>MM SERIES DOOR CAP FIXING PAWL</td> <td>4.000</td> <td>PC</td> </tr> <tr> <td>VM2959A0</td> <td></td> <td>1.000</td> <td>PC</td> </tr> </tbody> </table>	Code	Description	Qty	UOM	VE1030A1	MAGNET FOR DOOR MICROSWITC H D=22,9mm	1.000	PC	VI1220A1	4,2x12 TCB SELF-TAPPIN G SCREW	1.000	PC	VI1930A1	5x20 ST. STEEL CHIP SCREW	4.000	PC	VI1996A0	M5x35 SCREW	4.000	PC	VM2268A0	DOOR MAGNET COVER	1.000	PC	VM2305A0	MM SERIES DOOR CAP FIXING PAWL	4.000	PC	VM2959A0		1.000	PC			
Code	Description	Qty	UOM																																		
VE1030A1	MAGNET FOR DOOR MICROSWITC H D=22,9mm	1.000	PC																																		
VI1220A1	4,2x12 TCB SELF-TAPPIN G SCREW	1.000	PC																																		
VI1930A1	5x20 ST. STEEL CHIP SCREW	4.000	PC																																		
VI1996A0	M5x35 SCREW	4.000	PC																																		
VM2268A0	DOOR MAGNET COVER	1.000	PC																																		
VM2305A0	MM SERIES DOOR CAP FIXING PAWL	4.000	PC																																		
VM2959A0		1.000	PC																																		
KVM2262B	MIND.MAPS -M DOOR RIGHT UPPER CAP KIT	<table border="1"> <thead> <tr> <th>Code</th> <th>Description</th> <th>Qty</th> <th>UOM</th> </tr> </thead> <tbody> <tr> <td>VE1030A1</td> <td>MAGNET FOR DOOR MICROSWITC H D=22,9mm</td> <td>1.000</td> <td>PC</td> </tr> </tbody> </table>	Code	Description	Qty	UOM	VE1030A1	MAGNET FOR DOOR MICROSWITC H D=22,9mm	1.000	PC																											
Code	Description	Qty	UOM																																		
VE1030A1	MAGNET FOR DOOR MICROSWITC H D=22,9mm	1.000	PC																																		

COMPONENT			SPARE PART																															
Code	Description	Image	Code	Description	Kit components																													
VM2269B	INNER GLASS FIXING CAP		KVM2262B	MIND.MAPS -M DOOR RIGHT UPPER CAP KIT	<table border="1"> <thead> <tr> <th>Code</th> <th>Description</th> <th>Qty</th> <th>UOM</th> </tr> </thead> <tbody> <tr> <td>VI1220A1</td> <td>4,2x12 TCB SELF-TAPPIN G SCREW</td> <td>1.000</td> <td>PC</td> </tr> <tr> <td>VI1930A1</td> <td>5x20 ST. STEEL CHIP SCREW</td> <td>4.000</td> <td>PC</td> </tr> <tr> <td>VI1996A0</td> <td>M5x35 SCREW</td> <td>4.000</td> <td>PC</td> </tr> <tr> <td>VM2268A0</td> <td>DOOR MAGNET COVER</td> <td>1.000</td> <td>PC</td> </tr> <tr> <td>VM2305A0</td> <td>MM SERIES DOOR CAP FIXING PAWL</td> <td>4.000</td> <td>PC</td> </tr> <tr> <td>VM2956A0</td> <td></td> <td>1.000</td> <td>PC</td> </tr> </tbody> </table>	Code	Description	Qty	UOM	VI1220A1	4,2x12 TCB SELF-TAPPIN G SCREW	1.000	PC	VI1930A1	5x20 ST. STEEL CHIP SCREW	4.000	PC	VI1996A0	M5x35 SCREW	4.000	PC	VM2268A0	DOOR MAGNET COVER	1.000	PC	VM2305A0	MM SERIES DOOR CAP FIXING PAWL	4.000	PC	VM2956A0		1.000	PC	
			Code	Description	Qty	UOM																												
VI1220A1	4,2x12 TCB SELF-TAPPIN G SCREW	1.000	PC																															
VI1930A1	5x20 ST. STEEL CHIP SCREW	4.000	PC																															
VI1996A0	M5x35 SCREW	4.000	PC																															
VM2268A0	DOOR MAGNET COVER	1.000	PC																															
VM2305A0	MM SERIES DOOR CAP FIXING PAWL	4.000	PC																															
VM2956A0		1.000	PC																															
KVM2261B	MIND.MAPS -M DOOR RIGHT LOWER CAP KIT	<table border="1"> <thead> <tr> <th>Code</th> <th>Description</th> <th>Qty</th> <th>UOM</th> </tr> </thead> <tbody> <tr> <td>VE1030A1</td> <td>MAGNET FOR DOOR MICROSWITC H D=22,9mm</td> <td>1.000</td> <td>PC</td> </tr> <tr> <td>VI1220A1</td> <td>4,2x12 TCB SELF-TAPPIN G SCREW</td> <td>1.000</td> <td>PC</td> </tr> <tr> <td>VI1930A1</td> <td>5x20 ST. STEEL CHIP SCREW</td> <td>4.000</td> <td>PC</td> </tr> <tr> <td>VI1996A0</td> <td>M5x35 SCREW</td> <td>4.000</td> <td>PC</td> </tr> <tr> <td>VM2268A0</td> <td>DOOR MAGNET COVER</td> <td>1.000</td> <td>PC</td> </tr> <tr> <td>VM2305A0</td> <td>MM SERIES DOOR CAP FIXING PAWL</td> <td>4.000</td> <td>PC</td> </tr> <tr> <td>VM2957A0</td> <td></td> <td>1.000</td> <td>PC</td> </tr> </tbody> </table>	Code	Description	Qty	UOM	VE1030A1	MAGNET FOR DOOR MICROSWITC H D=22,9mm	1.000	PC	VI1220A1	4,2x12 TCB SELF-TAPPIN G SCREW	1.000	PC	VI1930A1	5x20 ST. STEEL CHIP SCREW	4.000	PC	VI1996A0	M5x35 SCREW	4.000	PC	VM2268A0	DOOR MAGNET COVER	1.000	PC	VM2305A0	MM SERIES DOOR CAP FIXING PAWL	4.000	PC	VM2957A0		1.000	PC
Code	Description	Qty	UOM																															
VE1030A1	MAGNET FOR DOOR MICROSWITC H D=22,9mm	1.000	PC																															
VI1220A1	4,2x12 TCB SELF-TAPPIN G SCREW	1.000	PC																															
VI1930A1	5x20 ST. STEEL CHIP SCREW	4.000	PC																															
VI1996A0	M5x35 SCREW	4.000	PC																															
VM2268A0	DOOR MAGNET COVER	1.000	PC																															
VM2305A0	MM SERIES DOOR CAP FIXING PAWL	4.000	PC																															
VM2957A0		1.000	PC																															
VM2305A	MM SERIES DOOR CAP FIXING PAWL		KVM2305A	MM FIXING DOOR THUB SCREWS 10 PCS KIT	<table border="1"> <thead> <tr> <th>Code</th> <th>Description</th> <th>Qty</th> <th>UOM</th> </tr> </thead> <tbody> <tr> <td>VM2305A0</td> <td>MM SERIES DOOR CAP FIXING PAWL</td> <td>10.000</td> <td>PC</td> </tr> </tbody> </table>	Code	Description	Qty	UOM	VM2305A0	MM SERIES DOOR CAP FIXING PAWL	10.000	PC																					
Code	Description	Qty	UOM																															
VM2305A0	MM SERIES DOOR CAP FIXING PAWL	10.000	PC																															
VI1074A	4X16 SCREW FOR PLASTIC		VI1074A0	4X16 SCREW FOR PLASTIC																														



COMPONENT			SPARE PART																										
Code	Description	Image	Code	Description	Kit components																								
VI1930A	5x20 ST. STEEL CHIP SCREW		VI1147A0	5X25 STAINLESS STEEL SCREW																									
VI1996A	M5x35 SCREW		VI1996A0	M5x35 SCREW																									
VM2260B	S6 LEFT UPPER CAP		KVM2260B	MM M RIGHT DOOR -LEFT UPPER CAP KI	<table border="1"> <thead> <tr> <th>Code</th> <th>Description</th> <th>Qty</th> <th>UOM</th> </tr> </thead> <tbody> <tr> <td>VI1930A1</td> <td>5x20 ST. STEEL CHIP SCREW</td> <td>4.000</td> <td>PC</td> </tr> <tr> <td>VI1996A0</td> <td>M5x35 SCREW</td> <td>2.000</td> <td>PC</td> </tr> <tr> <td>VM2275A0</td> <td>SMOOTH BUSHING</td> <td>1.000</td> <td>PC</td> </tr> <tr> <td>VM2305A0</td> <td>MM SERIES DOOR CAP FIXING PAWL</td> <td>3.000</td> <td>PC</td> </tr> <tr> <td>VM2958A0</td> <td>MM - M DOOR LEFT UPPPER CAP ASSEMBL</td> <td>1.000</td> <td>PC</td> </tr> </tbody> </table>	Code	Description	Qty	UOM	VI1930A1	5x20 ST. STEEL CHIP SCREW	4.000	PC	VI1996A0	M5x35 SCREW	2.000	PC	VM2275A0	SMOOTH BUSHING	1.000	PC	VM2305A0	MM SERIES DOOR CAP FIXING PAWL	3.000	PC	VM2958A0	MM - M DOOR LEFT UPPPER CAP ASSEMBL	1.000	PC
Code	Description	Qty	UOM																										
VI1930A1	5x20 ST. STEEL CHIP SCREW	4.000	PC																										
VI1996A0	M5x35 SCREW	2.000	PC																										
VM2275A0	SMOOTH BUSHING	1.000	PC																										
VM2305A0	MM SERIES DOOR CAP FIXING PAWL	3.000	PC																										
VM2958A0	MM - M DOOR LEFT UPPPER CAP ASSEMBL	1.000	PC																										
VM2275A	SMOOTH BUSHING		KVM2275A	SMOOTH PIN BUSHING KIT	<table border="1"> <thead> <tr> <th>Code</th> <th>Description</th> <th>Qty</th> <th>UOM</th> </tr> </thead> <tbody> <tr> <td>VM2275A0</td> <td>SMOOTH BUSHING</td> <td>1.000</td> <td>PC</td> </tr> </tbody> </table>	Code	Description	Qty	UOM	VM2275A0	SMOOTH BUSHING	1.000	PC																
Code	Description	Qty	UOM																										
VM2275A0	SMOOTH BUSHING	1.000	PC																										
VM2305A	MM SERIES DOOR CAP FIXING PAWL		KVM2305A	MM FIXING DOOR THUB SCREWS 10 PCS KIT	<table border="1"> <thead> <tr> <th>Code</th> <th>Description</th> <th>Qty</th> <th>UOM</th> </tr> </thead> <tbody> <tr> <td>VM2305A0</td> <td>MM SERIES DOOR CAP FIXING PAWL</td> <td>10.000</td> <td>PC</td> </tr> </tbody> </table>	Code	Description	Qty	UOM	VM2305A0	MM SERIES DOOR CAP FIXING PAWL	10.000	PC																
Code	Description	Qty	UOM																										
VM2305A0	MM SERIES DOOR CAP FIXING PAWL	10.000	PC																										



COMPONENT			SPARE PART																										
Code	Description	Image	Code	Description	Kit components																								
VP1081A	UPPER HINGE CAP FOR UPPER INNER GLASS		KVM2260B	MM M RIGHT DOOR -LEFT UPPER CAP KI	<table border="1"> <thead> <tr> <th>Code</th> <th>Description</th> <th>Qty</th> <th>UOM</th> </tr> </thead> <tbody> <tr> <td>VI1930A1</td> <td>5x20 ST. STEEL CHIP SCREW</td> <td>4.000</td> <td>PC</td> </tr> <tr> <td>VI1996A0</td> <td>M5x35 SCREW</td> <td>2.000</td> <td>PC</td> </tr> <tr> <td>VM2275A0</td> <td>SMOOTH BUSHING</td> <td>1.000</td> <td>PC</td> </tr> <tr> <td>VM2305A0</td> <td>MM SERIES DOOR CAP FIXING PAWL</td> <td>3.000</td> <td>PC</td> </tr> <tr> <td>VM2958A0</td> <td>MM - M DOOR LEFT UPPER CAP ASSEMBL</td> <td>1.000</td> <td>PC</td> </tr> </tbody> </table>	Code	Description	Qty	UOM	VI1930A1	5x20 ST. STEEL CHIP SCREW	4.000	PC	VI1996A0	M5x35 SCREW	2.000	PC	VM2275A0	SMOOTH BUSHING	1.000	PC	VM2305A0	MM SERIES DOOR CAP FIXING PAWL	3.000	PC	VM2958A0	MM - M DOOR LEFT UPPER CAP ASSEMBL	1.000	PC
Code	Description	Qty	UOM																										
VI1930A1	5x20 ST. STEEL CHIP SCREW	4.000	PC																										
VI1996A0	M5x35 SCREW	2.000	PC																										
VM2275A0	SMOOTH BUSHING	1.000	PC																										
VM2305A0	MM SERIES DOOR CAP FIXING PAWL	3.000	PC																										
VM2958A0	MM - M DOOR LEFT UPPER CAP ASSEMBL	1.000	PC																										
VI1074A	4X16 SCREW FOR PLASTIC		VI1074A0	4X16 SCREW FOR PLASTIC																									
VI1930A	5x20 ST. STEEL CHIP SCREW		VI1147A0	5X25 STAINLESS STEEL SCREW																									
VI1996A	M5x35 SCREW		VI1996A0	M5x35 SCREW																									
VM2259B	VM2259B0		KVM2259B	MM -M RIGHT DOOR LEFT LOWER CAP KI	<table border="1"> <thead> <tr> <th>Code</th> <th>Description</th> <th>Qty</th> <th>UOM</th> </tr> </thead> <tbody> <tr> <td>VI1103A0</td> <td>40X12 TBSP SCREW FOR PLASTIC</td> <td>1.000</td> <td>PC</td> </tr> <tr> <td>VI1930A1</td> <td>5x20 ST. STEEL CHIP SCREW</td> <td>4.000</td> <td>PC</td> </tr> <tr> <td>VI1996A0</td> <td>M5x35 SCREW</td> <td>3.000</td> <td>PC</td> </tr> <tr> <td>VM2259B0</td> <td>VM2259B0</td> <td>1.000</td> <td>PC</td> </tr> <tr> <td>VM2274A0</td> <td>GROOVED BUSHING</td> <td>1.000</td> <td>PC</td> </tr> </tbody> </table>	Code	Description	Qty	UOM	VI1103A0	40X12 TBSP SCREW FOR PLASTIC	1.000	PC	VI1930A1	5x20 ST. STEEL CHIP SCREW	4.000	PC	VI1996A0	M5x35 SCREW	3.000	PC	VM2259B0	VM2259B0	1.000	PC	VM2274A0	GROOVED BUSHING	1.000	PC
Code	Description	Qty	UOM																										
VI1103A0	40X12 TBSP SCREW FOR PLASTIC	1.000	PC																										
VI1930A1	5x20 ST. STEEL CHIP SCREW	4.000	PC																										
VI1996A0	M5x35 SCREW	3.000	PC																										
VM2259B0	VM2259B0	1.000	PC																										
VM2274A0	GROOVED BUSHING	1.000	PC																										



COMPONENT			SPARE PART																																																																		
Code	Description	Image	Code	Description	Kit components																																																																
VM2259B	VM2259B0		KVM2259B	MM -M RIGHT DOOR LEFT LOWER CAP KI	<table border="1"> <thead> <tr> <th>Code</th> <th>Description</th> <th>Qty</th> <th>UOM</th> </tr> </thead> <tbody> <tr> <td>VM2305A0</td> <td>MM SERIES DOOR CAP FIXING PAWL</td> <td>3.000</td> <td>PC</td> </tr> <tr> <td>VP1080A0</td> <td>UPPER HINGE CAP FOR LOWER INNER GLASS</td> <td>1.000</td> <td>PC</td> </tr> </tbody> </table>	Code	Description	Qty	UOM	VM2305A0	MM SERIES DOOR CAP FIXING PAWL	3.000	PC	VP1080A0	UPPER HINGE CAP FOR LOWER INNER GLASS	1.000	PC																																																				
Code	Description	Qty	UOM																																																																		
VM2305A0	MM SERIES DOOR CAP FIXING PAWL	3.000	PC																																																																		
VP1080A0	UPPER HINGE CAP FOR LOWER INNER GLASS	1.000	PC																																																																		
VM2274A	GROOVED BUSHING		KVM2274A K0B1126AR K0B1126AL	GROOVED PIN BUSHING KIT BAKERTOP MM RIGHT DOOR LOWER BEAM KIT EU AND 2/1 MM LEFT DOOR LOWER BEAM KIT	<table border="1"> <thead> <tr> <th>Code</th> <th>Description</th> <th>Qty</th> <th>UOM</th> </tr> </thead> <tbody> <tr> <td>VM2274A0</td> <td>GROOVED BUSHING</td> <td>1.000</td> <td>PC</td> </tr> <tr> <td>0B1126A1</td> <td>860mm DOOR LOWER FRAME SHAPE</td> <td>1.000</td> <td>PC</td> </tr> <tr> <td>RC1200A0</td> <td>ED=4 WIRE D=0.5 H24 COMPRESSIO N SPRING</td> <td>2.000</td> <td>PC</td> </tr> <tr> <td>VI1220A1</td> <td>4,2x12 TCB SELF-TAPPIN G SCREW</td> <td>1.000</td> <td>PC</td> </tr> <tr> <td>VI1996A0</td> <td>M5x35 SCREW</td> <td>7.000</td> <td>PC</td> </tr> <tr> <td>VM1794A0</td> <td>250x4.8 PA66 BLACK CLAMP</td> <td>2.000</td> <td>PC</td> </tr> <tr> <td>VM2103A0</td> <td>CLAMP LOCK</td> <td>2.000</td> <td>PC</td> </tr> <tr> <td>VM2259A1</td> <td>6 SERIES DOOR LOWER LEFT CAP</td> <td>1.000</td> <td>PC</td> </tr> <tr> <td>VM2261A1</td> <td>MM DOOR LOWER RIGHT CAP</td> <td>1.000</td> <td>PC</td> </tr> <tr> <td>VM2267A1</td> <td></td> <td>1.000</td> <td>PC</td> </tr> <tr> <td>VM2269A0</td> <td>INTERNAL GLASS LOCKING SYSTEM CAP</td> <td>1.000</td> <td>PC</td> </tr> <tr> <td>VM2274A0</td> <td>GROOVED BUSHING</td> <td>1.000</td> <td>PC</td> </tr> <tr> <td>VM2305A0</td> <td>MM SERIES DOOR CAP FIXING PAWL</td> <td>7.000</td> <td>PC</td> </tr> <tr> <td>0B1126A1</td> <td>860mm DOOR LOWER FRAME SHAPE</td> <td>1.000</td> <td>PC</td> </tr> <tr> <td>RC1200A0</td> <td>ED=4 WIRE D=0.5 H24 COMPRESSIO N SPRING</td> <td>2.000</td> <td>PC</td> </tr> </tbody> </table>	Code	Description	Qty	UOM	VM2274A0	GROOVED BUSHING	1.000	PC	0B1126A1	860mm DOOR LOWER FRAME SHAPE	1.000	PC	RC1200A0	ED=4 WIRE D=0.5 H24 COMPRESSIO N SPRING	2.000	PC	VI1220A1	4,2x12 TCB SELF-TAPPIN G SCREW	1.000	PC	VI1996A0	M5x35 SCREW	7.000	PC	VM1794A0	250x4.8 PA66 BLACK CLAMP	2.000	PC	VM2103A0	CLAMP LOCK	2.000	PC	VM2259A1	6 SERIES DOOR LOWER LEFT CAP	1.000	PC	VM2261A1	MM DOOR LOWER RIGHT CAP	1.000	PC	VM2267A1		1.000	PC	VM2269A0	INTERNAL GLASS LOCKING SYSTEM CAP	1.000	PC	VM2274A0	GROOVED BUSHING	1.000	PC	VM2305A0	MM SERIES DOOR CAP FIXING PAWL	7.000	PC	0B1126A1	860mm DOOR LOWER FRAME SHAPE	1.000	PC	RC1200A0	ED=4 WIRE D=0.5 H24 COMPRESSIO N SPRING	2.000	PC
Code	Description	Qty	UOM																																																																		
VM2274A0	GROOVED BUSHING	1.000	PC																																																																		
0B1126A1	860mm DOOR LOWER FRAME SHAPE	1.000	PC																																																																		
RC1200A0	ED=4 WIRE D=0.5 H24 COMPRESSIO N SPRING	2.000	PC																																																																		
VI1220A1	4,2x12 TCB SELF-TAPPIN G SCREW	1.000	PC																																																																		
VI1996A0	M5x35 SCREW	7.000	PC																																																																		
VM1794A0	250x4.8 PA66 BLACK CLAMP	2.000	PC																																																																		
VM2103A0	CLAMP LOCK	2.000	PC																																																																		
VM2259A1	6 SERIES DOOR LOWER LEFT CAP	1.000	PC																																																																		
VM2261A1	MM DOOR LOWER RIGHT CAP	1.000	PC																																																																		
VM2267A1		1.000	PC																																																																		
VM2269A0	INTERNAL GLASS LOCKING SYSTEM CAP	1.000	PC																																																																		
VM2274A0	GROOVED BUSHING	1.000	PC																																																																		
VM2305A0	MM SERIES DOOR CAP FIXING PAWL	7.000	PC																																																																		
0B1126A1	860mm DOOR LOWER FRAME SHAPE	1.000	PC																																																																		
RC1200A0	ED=4 WIRE D=0.5 H24 COMPRESSIO N SPRING	2.000	PC																																																																		





COMPONENT			SPARE PART																																														
Code	Description	Image	Code	Description	Kit components																																												
VM2274A	GROOVED BUSHING		K0B1126AL	EU AND 2/1 MM LEFT DOOR LOWER BEAM KIT	<table border="1"> <thead> <tr> <th>Code</th> <th>Description</th> <th>Qty</th> <th>UOM</th> </tr> </thead> <tbody> <tr> <td>VI1220A1</td> <td>4,2x12 TCB SELF-TAPPIN G SCREW</td> <td>1.000</td> <td>PC</td> </tr> <tr> <td>VI1996A0</td> <td>M5x35 SCREW</td> <td>7.000</td> <td>PC</td> </tr> <tr> <td>VM1794A0</td> <td>250x4.8 PA66 BLACK CLAMP</td> <td>2.000</td> <td>PC</td> </tr> <tr> <td>VM2103A0</td> <td>CLAMP LOCK</td> <td>2.000</td> <td>PC</td> </tr> <tr> <td>VM2267A1</td> <td></td> <td>1.000</td> <td>PC</td> </tr> <tr> <td>VM2269A0</td> <td>INTERNAL GLASS LOCKING SYSTEM CAP</td> <td>1.000</td> <td>PC</td> </tr> <tr> <td>VM2274A0</td> <td>GROOVED BUSHING</td> <td>1.000</td> <td>PC</td> </tr> <tr> <td>VM2305A0</td> <td>MM SERIES DOOR CAP FIXING PAWL</td> <td>7.000</td> <td>PC</td> </tr> <tr> <td>VM2384A0</td> <td>MM LEFT DOOR RIGHT LOWER CAP</td> <td>1.000</td> <td>PC</td> </tr> <tr> <td>VM2386A1</td> <td>LEFT MM DOOR LOWER LEFT CAP</td> <td>1.000</td> <td>PC</td> </tr> </tbody> </table>	Code	Description	Qty	UOM	VI1220A1	4,2x12 TCB SELF-TAPPIN G SCREW	1.000	PC	VI1996A0	M5x35 SCREW	7.000	PC	VM1794A0	250x4.8 PA66 BLACK CLAMP	2.000	PC	VM2103A0	CLAMP LOCK	2.000	PC	VM2267A1		1.000	PC	VM2269A0	INTERNAL GLASS LOCKING SYSTEM CAP	1.000	PC	VM2274A0	GROOVED BUSHING	1.000	PC	VM2305A0	MM SERIES DOOR CAP FIXING PAWL	7.000	PC	VM2384A0	MM LEFT DOOR RIGHT LOWER CAP	1.000	PC	VM2386A1	LEFT MM DOOR LOWER LEFT CAP	1.000	PC
			Code	Description	Qty	UOM																																											
VI1220A1	4,2x12 TCB SELF-TAPPIN G SCREW	1.000	PC																																														
VI1996A0	M5x35 SCREW	7.000	PC																																														
VM1794A0	250x4.8 PA66 BLACK CLAMP	2.000	PC																																														
VM2103A0	CLAMP LOCK	2.000	PC																																														
VM2267A1		1.000	PC																																														
VM2269A0	INTERNAL GLASS LOCKING SYSTEM CAP	1.000	PC																																														
VM2274A0	GROOVED BUSHING	1.000	PC																																														
VM2305A0	MM SERIES DOOR CAP FIXING PAWL	7.000	PC																																														
VM2384A0	MM LEFT DOOR RIGHT LOWER CAP	1.000	PC																																														
VM2386A1	LEFT MM DOOR LOWER LEFT CAP	1.000	PC																																														
K0B1122AR	CHEFTOP MM RIGHT DOOR LOWER BEAM KIT	<table border="1"> <thead> <tr> <th>Code</th> <th>Description</th> <th>Qty</th> <th>UOM</th> </tr> </thead> <tbody> <tr> <td>OB1122A1</td> <td>750MM DOOR LOWER FRAME SHAPE</td> <td>1.000</td> <td>PC</td> </tr> <tr> <td>RC1200A0</td> <td>ED=4 WIRE D=0.5 H24 COMPRESSION N SPRING</td> <td>2.000</td> <td>PC</td> </tr> <tr> <td>VI1220A1</td> <td>4,2x12 TCB SELF-TAPPIN G SCREW</td> <td>1.000</td> <td>PC</td> </tr> <tr> <td>VI1996A0</td> <td>M5x35 SCREW</td> <td>7.000</td> <td>PC</td> </tr> <tr> <td>VM2259A1</td> <td>6 SERIES DOOR LOWER LEFT CAP</td> <td>1.000</td> <td>PC</td> </tr> <tr> <td>VM2261A1</td> <td>MM DOOR LOWER RIGHT CAP</td> <td>1.000</td> <td>PC</td> </tr> <tr> <td>VM2267A1</td> <td></td> <td>1.000</td> <td>PC</td> </tr> <tr> <td>VM2269A0</td> <td>INTERNAL GLASS LOCKING SYSTEM CAP</td> <td>1.000</td> <td>PC</td> </tr> <tr> <td>VM2274A0</td> <td>GROOVED BUSHING</td> <td>1.000</td> <td>PC</td> </tr> <tr> <td>VM2305A0</td> <td>MM SERIES DOOR CAP FIXING PAWL</td> <td>7.000</td> <td>PC</td> </tr> </tbody> </table>	Code	Description	Qty	UOM	OB1122A1	750MM DOOR LOWER FRAME SHAPE	1.000	PC	RC1200A0	ED=4 WIRE D=0.5 H24 COMPRESSION N SPRING	2.000	PC	VI1220A1	4,2x12 TCB SELF-TAPPIN G SCREW	1.000	PC	VI1996A0	M5x35 SCREW	7.000	PC	VM2259A1	6 SERIES DOOR LOWER LEFT CAP	1.000	PC	VM2261A1	MM DOOR LOWER RIGHT CAP	1.000	PC	VM2267A1		1.000	PC	VM2269A0	INTERNAL GLASS LOCKING SYSTEM CAP	1.000	PC	VM2274A0	GROOVED BUSHING	1.000	PC	VM2305A0	MM SERIES DOOR CAP FIXING PAWL	7.000	PC			
Code	Description	Qty	UOM																																														
OB1122A1	750MM DOOR LOWER FRAME SHAPE	1.000	PC																																														
RC1200A0	ED=4 WIRE D=0.5 H24 COMPRESSION N SPRING	2.000	PC																																														
VI1220A1	4,2x12 TCB SELF-TAPPIN G SCREW	1.000	PC																																														
VI1996A0	M5x35 SCREW	7.000	PC																																														
VM2259A1	6 SERIES DOOR LOWER LEFT CAP	1.000	PC																																														
VM2261A1	MM DOOR LOWER RIGHT CAP	1.000	PC																																														
VM2267A1		1.000	PC																																														
VM2269A0	INTERNAL GLASS LOCKING SYSTEM CAP	1.000	PC																																														
VM2274A0	GROOVED BUSHING	1.000	PC																																														
VM2305A0	MM SERIES DOOR CAP FIXING PAWL	7.000	PC																																														



COMPONENT			SPARE PART																																																						
Code	Description	Image	Code	Description	Kit components																																																				
VM2274A	GROOVED BUSHING		K0B1122AL	CHEFTOP MM LEFT DOOR LOWER BEAM KIT	<table border="1"> <thead> <tr> <th>Code</th> <th>Description</th> <th>Qty</th> <th>UOM</th> </tr> </thead> <tbody> <tr> <td>0B1122A1</td> <td>750MM DOOR LOWER FRAME SHAPE</td> <td>1.000</td> <td>PC</td> </tr> <tr> <td>RC1200A0</td> <td>ED=4 WIRE D=0.5 H24 COMPRESSION SPRING</td> <td>2.000</td> <td>PC</td> </tr> <tr> <td>V11220A1</td> <td>4,2x12 TCB SELF-TAPPING SCREW</td> <td>1.000</td> <td>PC</td> </tr> <tr> <td>V11996A0</td> <td>M5x35 SCREW</td> <td>7.000</td> <td>PC</td> </tr> <tr> <td>VM1794A0</td> <td>250x4.8 PA66 BLACK CLAMP</td> <td>2.000</td> <td>PC</td> </tr> <tr> <td>VM2103A0</td> <td>CLAMP LOCK</td> <td>2.000</td> <td>PC</td> </tr> <tr> <td>VM2267A1</td> <td></td> <td>1.000</td> <td>PC</td> </tr> <tr> <td>VM2269A0</td> <td>INTERNAL GLASS LOCKING SYSTEM CAP</td> <td>1.000</td> <td>PC</td> </tr> <tr> <td>VM2274A0</td> <td>GROOVED BUSHING</td> <td>1.000</td> <td>PC</td> </tr> <tr> <td>VM2305A0</td> <td>MM SERIES DOOR CAP FIXING PAWL</td> <td>7.000</td> <td>PC</td> </tr> <tr> <td>VM2384A0</td> <td>MM LEFT DOOR RIGHT LOWER CAP</td> <td>1.000</td> <td>PC</td> </tr> <tr> <td>VM2386A1</td> <td>LEFT MM DOOR LOWER LEFT CAP</td> <td>1.000</td> <td>PC</td> </tr> </tbody> </table>	Code	Description	Qty	UOM	0B1122A1	750MM DOOR LOWER FRAME SHAPE	1.000	PC	RC1200A0	ED=4 WIRE D=0.5 H24 COMPRESSION SPRING	2.000	PC	V11220A1	4,2x12 TCB SELF-TAPPING SCREW	1.000	PC	V11996A0	M5x35 SCREW	7.000	PC	VM1794A0	250x4.8 PA66 BLACK CLAMP	2.000	PC	VM2103A0	CLAMP LOCK	2.000	PC	VM2267A1		1.000	PC	VM2269A0	INTERNAL GLASS LOCKING SYSTEM CAP	1.000	PC	VM2274A0	GROOVED BUSHING	1.000	PC	VM2305A0	MM SERIES DOOR CAP FIXING PAWL	7.000	PC	VM2384A0	MM LEFT DOOR RIGHT LOWER CAP	1.000	PC	VM2386A1	LEFT MM DOOR LOWER LEFT CAP	1.000	PC
Code	Description	Qty	UOM																																																						
0B1122A1	750MM DOOR LOWER FRAME SHAPE	1.000	PC																																																						
RC1200A0	ED=4 WIRE D=0.5 H24 COMPRESSION SPRING	2.000	PC																																																						
V11220A1	4,2x12 TCB SELF-TAPPING SCREW	1.000	PC																																																						
V11996A0	M5x35 SCREW	7.000	PC																																																						
VM1794A0	250x4.8 PA66 BLACK CLAMP	2.000	PC																																																						
VM2103A0	CLAMP LOCK	2.000	PC																																																						
VM2267A1		1.000	PC																																																						
VM2269A0	INTERNAL GLASS LOCKING SYSTEM CAP	1.000	PC																																																						
VM2274A0	GROOVED BUSHING	1.000	PC																																																						
VM2305A0	MM SERIES DOOR CAP FIXING PAWL	7.000	PC																																																						
VM2384A0	MM LEFT DOOR RIGHT LOWER CAP	1.000	PC																																																						
VM2386A1	LEFT MM DOOR LOWER LEFT CAP	1.000	PC																																																						
VM2305A	MM SERIES DOOR CAP FIXING PAWL		KVM2305A	MM FIXING DOOR THUB SCREWS 10 PCS KIT	<table border="1"> <thead> <tr> <th>Code</th> <th>Description</th> <th>Qty</th> <th>UOM</th> </tr> </thead> <tbody> <tr> <td>VM2305A0</td> <td>MM SERIES DOOR CAP FIXING PAWL</td> <td>10.000</td> <td>PC</td> </tr> </tbody> </table>	Code	Description	Qty	UOM	VM2305A0	MM SERIES DOOR CAP FIXING PAWL	10.000	PC																																												
Code	Description	Qty	UOM																																																						
VM2305A0	MM SERIES DOOR CAP FIXING PAWL	10.000	PC																																																						
VP1080A	UPPER HINGE CAP FOR LOWER INNER GLASS		KVM2259B	MM -M RIGHT DOOR LEFT LOWER CAP KI	<table border="1"> <thead> <tr> <th>Code</th> <th>Description</th> <th>Qty</th> <th>UOM</th> </tr> </thead> <tbody> <tr> <td>V1103A0</td> <td>40X12 TBSP SCREW FOR PLASTIC</td> <td>1.000</td> <td>PC</td> </tr> <tr> <td>V11930A1</td> <td>5x20 ST. STEEL CHIP SCREW</td> <td>4.000</td> <td>PC</td> </tr> <tr> <td>V11996A0</td> <td>M5x35 SCREW</td> <td>3.000</td> <td>PC</td> </tr> <tr> <td>VM2259B0</td> <td>VM2259B0</td> <td>1.000</td> <td>PC</td> </tr> <tr> <td>VM2274A0</td> <td>GROOVED BUSHING</td> <td>1.000</td> <td>PC</td> </tr> <tr> <td>VM2305A0</td> <td>MM SERIES DOOR CAP FIXING PAWL</td> <td>3.000</td> <td>PC</td> </tr> <tr> <td>VP1080A0</td> <td>UPPER HINGE CAP FOR LOWER INNER GLASS</td> <td>1.000</td> <td>PC</td> </tr> </tbody> </table>	Code	Description	Qty	UOM	V1103A0	40X12 TBSP SCREW FOR PLASTIC	1.000	PC	V11930A1	5x20 ST. STEEL CHIP SCREW	4.000	PC	V11996A0	M5x35 SCREW	3.000	PC	VM2259B0	VM2259B0	1.000	PC	VM2274A0	GROOVED BUSHING	1.000	PC	VM2305A0	MM SERIES DOOR CAP FIXING PAWL	3.000	PC	VP1080A0	UPPER HINGE CAP FOR LOWER INNER GLASS	1.000	PC																				
Code	Description	Qty	UOM																																																						
V1103A0	40X12 TBSP SCREW FOR PLASTIC	1.000	PC																																																						
V11930A1	5x20 ST. STEEL CHIP SCREW	4.000	PC																																																						
V11996A0	M5x35 SCREW	3.000	PC																																																						
VM2259B0	VM2259B0	1.000	PC																																																						
VM2274A0	GROOVED BUSHING	1.000	PC																																																						
VM2305A0	MM SERIES DOOR CAP FIXING PAWL	3.000	PC																																																						
VP1080A0	UPPER HINGE CAP FOR LOWER INNER GLASS	1.000	PC																																																						



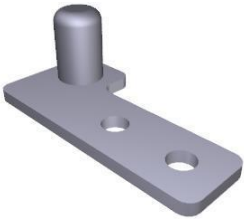



COMPONENT			SPARE PART																		
Code	Description	Image	Code	Description	Kit components																
VM2284B	750 SERIES DRIP PROFILE KIT		KVM2284B	750 -M SERIES DRIP PROFILE KIT	<table border="1"> <thead> <tr> <th>Code</th> <th>Description</th> <th>Qty</th> <th>UOM</th> </tr> </thead> <tbody> <tr> <td>VM2284B0</td> <td>750 SERIES DRIP PROFILE KIT</td> <td>1.000</td> <td>PC</td> </tr> </tbody> </table>	Code	Description	Qty	UOM	VM2284B0	750 SERIES DRIP PROFILE KIT	1.000	PC								
Code	Description	Qty	UOM																		
VM2284B0	750 SERIES DRIP PROFILE KIT	1.000	PC																		
VM2312A	MM DRIP PROFILE DRAIN LEFT PIPE		KVM2312A	M.M. DRIP TRAY LEFT DRAIN PIPE KI	<table border="1"> <thead> <tr> <th>Code</th> <th>Description</th> <th>Qty</th> <th>UOM</th> </tr> </thead> <tbody> <tr> <td>VI1220A1</td> <td>4,2x12 TCB SELF-TAPPIN G SCREW</td> <td>1.000</td> <td>PC</td> </tr> <tr> <td>VM2312A0</td> <td>MM DRIP PROFILE DRAIN LEFT PIPE</td> <td>1.000</td> <td>PC</td> </tr> </tbody> </table>	Code	Description	Qty	UOM	VI1220A1	4,2x12 TCB SELF-TAPPIN G SCREW	1.000	PC	VM2312A0	MM DRIP PROFILE DRAIN LEFT PIPE	1.000	PC				
Code	Description	Qty	UOM																		
VI1220A1	4,2x12 TCB SELF-TAPPIN G SCREW	1.000	PC																		
VM2312A0	MM DRIP PROFILE DRAIN LEFT PIPE	1.000	PC																		
VM2314A	MM DRIP PROFILE CAP		KVM2314A	MIND.Maps DRIP TRAY CAP	<table border="1"> <thead> <tr> <th>Code</th> <th>Description</th> <th>Qty</th> <th>UOM</th> </tr> </thead> <tbody> <tr> <td>GN1525A0</td> <td>O-RING INT DIAM 9,5 THK 1 NBR 70</td> <td>1.000</td> <td>PC</td> </tr> <tr> <td>VI1103A0</td> <td>40X12 TBSP SCREW FOR PLASTIC</td> <td>1.000</td> <td>PC</td> </tr> <tr> <td>VM2314A0</td> <td>MM DRIP PROFILE CAP</td> <td>1.000</td> <td>PC</td> </tr> </tbody> </table>	Code	Description	Qty	UOM	GN1525A0	O-RING INT DIAM 9,5 THK 1 NBR 70	1.000	PC	VI1103A0	40X12 TBSP SCREW FOR PLASTIC	1.000	PC	VM2314A0	MM DRIP PROFILE CAP	1.000	PC
Code	Description	Qty	UOM																		
GN1525A0	O-RING INT DIAM 9,5 THK 1 NBR 70	1.000	PC																		
VI1103A0	40X12 TBSP SCREW FOR PLASTIC	1.000	PC																		
VM2314A0	MM DRIP PROFILE CAP	1.000	PC																		
VM1631A	PLUS INNER GLASS PUSHING CAP		KVM1631A	CAP FOR INTERNAL GLASS 10 PCS KIT	<table border="1"> <thead> <tr> <th>Code</th> <th>Description</th> <th>Qty</th> <th>UOM</th> </tr> </thead> <tbody> <tr> <td>VM1631A0</td> <td>PLUS INNER GLASS PUSHING CAP</td> <td>10.000</td> <td>PC</td> </tr> </tbody> </table>	Code	Description	Qty	UOM	VM1631A0	PLUS INNER GLASS PUSHING CAP	10.000	PC								
Code	Description	Qty	UOM																		
VM1631A0	PLUS INNER GLASS PUSHING CAP	10.000	PC																		
VM2505B	MM PLUS INTERNAL GLASS SUPPORT		KVM2505B	CAP FOR INTERNAL DOUBLE GLASS 3PCS KIT	<table border="1"> <thead> <tr> <th>Code</th> <th>Description</th> <th>Qty</th> <th>UOM</th> </tr> </thead> <tbody> <tr> <td>VI1220A1</td> <td>4,2x12 TCB SELF-TAPPIN G SCREW</td> <td>3.000</td> <td>PC</td> </tr> <tr> <td>VM1631A0</td> <td>PLUS INNER GLASS PUSHING CAP</td> <td>3.000</td> <td>PC</td> </tr> <tr> <td>VM2505B1</td> <td>MM PLUS INTERNAL GLASS SUPPORT</td> <td>3.000</td> <td>PC</td> </tr> </tbody> </table>	Code	Description	Qty	UOM	VI1220A1	4,2x12 TCB SELF-TAPPIN G SCREW	3.000	PC	VM1631A0	PLUS INNER GLASS PUSHING CAP	3.000	PC	VM2505B1	MM PLUS INTERNAL GLASS SUPPORT	3.000	PC
Code	Description	Qty	UOM																		
VI1220A1	4,2x12 TCB SELF-TAPPIN G SCREW	3.000	PC																		
VM1631A0	PLUS INNER GLASS PUSHING CAP	3.000	PC																		
VM2505B1	MM PLUS INTERNAL GLASS SUPPORT	3.000	PC																		

COMPONENT			SPARE PART																																										
Code	Description	Image	Code	Description	Kit components																																								
CR1105A	HINGES INTERNAL GLASS DOUBLE		KCR1105A	MIND.Maps PLUS INTERNAL GLASS HINGES KIT	<table border="1"> <thead> <tr> <th>Code</th> <th>Description</th> <th>Qty</th> <th>UOM</th> </tr> </thead> <tbody> <tr> <td>CR1105A0</td> <td>HINGES INTERNAL GLASS DOUBL</td> <td>1.000</td> <td>PC</td> </tr> <tr> <td>CR1106A0</td> <td>HINGES INTERNAL GLASS DOUBL</td> <td>1.000</td> <td>PC</td> </tr> <tr> <td>VI1220A1</td> <td>4,2x12 TCB SELF-TAPPIN G SCREW</td> <td>4.000</td> <td>PC</td> </tr> </tbody> </table>	Code	Description	Qty	UOM	CR1105A0	HINGES INTERNAL GLASS DOUBL	1.000	PC	CR1106A0	HINGES INTERNAL GLASS DOUBL	1.000	PC	VI1220A1	4,2x12 TCB SELF-TAPPIN G SCREW	4.000	PC																								
Code	Description	Qty	UOM																																										
CR1105A0	HINGES INTERNAL GLASS DOUBL	1.000	PC																																										
CR1106A0	HINGES INTERNAL GLASS DOUBL	1.000	PC																																										
VI1220A1	4,2x12 TCB SELF-TAPPIN G SCREW	4.000	PC																																										
CR1106A	HINGES INTERNAL GLASS DOUBLE		KCR1105A	MIND.Maps PLUS INTERNAL GLASS HINGES KIT	<table border="1"> <thead> <tr> <th>Code</th> <th>Description</th> <th>Qty</th> <th>UOM</th> </tr> </thead> <tbody> <tr> <td>CR1105A0</td> <td>HINGES INTERNAL GLASS DOUBL</td> <td>1.000</td> <td>PC</td> </tr> <tr> <td>CR1106A0</td> <td>HINGES INTERNAL GLASS DOUBL</td> <td>1.000</td> <td>PC</td> </tr> <tr> <td>VI1220A1</td> <td>4,2x12 TCB SELF-TAPPIN G SCREW</td> <td>4.000</td> <td>PC</td> </tr> </tbody> </table>	Code	Description	Qty	UOM	CR1105A0	HINGES INTERNAL GLASS DOUBL	1.000	PC	CR1106A0	HINGES INTERNAL GLASS DOUBL	1.000	PC	VI1220A1	4,2x12 TCB SELF-TAPPIN G SCREW	4.000	PC																								
Code	Description	Qty	UOM																																										
CR1105A0	HINGES INTERNAL GLASS DOUBL	1.000	PC																																										
CR1106A0	HINGES INTERNAL GLASS DOUBL	1.000	PC																																										
VI1220A1	4,2x12 TCB SELF-TAPPIN G SCREW	4.000	PC																																										
VT1286B	1011 639x789x4 INNER DOUBLE GLASS		KVT1286B	1011 INTERNAL DOUBLE GLASS KIT	<table border="1"> <thead> <tr> <th>Code</th> <th>Description</th> <th>Qty</th> <th>UOM</th> </tr> </thead> <tbody> <tr> <td>0B1180A0</td> <td>GN1/1 INT DOUBLE GLASS INF-SUP BEAM</td> <td>2.000</td> <td>PC</td> </tr> <tr> <td>0B1183A0</td> <td>1011 DOUBLE GLASS RIGHT-LEFT PROFILE</td> <td>2.000</td> <td>PC</td> </tr> <tr> <td>0B1210A1</td> <td>GN1/1 DOUBLE GLASS EXT SUP-INF PROFILE</td> <td>2.000</td> <td>PC</td> </tr> <tr> <td>0B1214A3</td> <td>1011 DOUBLE GLASS LEFT-RIGHT EXT PROFILE</td> <td>2.000</td> <td>PC</td> </tr> <tr> <td>CR1105A0</td> <td>HINGES INTERNAL GLASS DOUBL</td> <td>1.000</td> <td>PC</td> </tr> <tr> <td>CR1106A0</td> <td>HINGES INTERNAL GLASS DOUBL</td> <td>1.000</td> <td>PC</td> </tr> <tr> <td>VI1220A1</td> <td>4,2x12 TCB SELF-TAPPIN G SCREW</td> <td>4.000</td> <td>PC</td> </tr> <tr> <td>VI1225A0</td> <td>STAINLESS STEEL STRUCTURE RIVET 4x10.1</td> <td>20.000</td> <td>PC</td> </tr> <tr> <td>VT1286B0</td> <td>1011 639x789x4 INNER DOUBLE GLAS</td> <td>2.000</td> <td>PC</td> </tr> </tbody> </table>	Code	Description	Qty	UOM	0B1180A0	GN1/1 INT DOUBLE GLASS INF-SUP BEAM	2.000	PC	0B1183A0	1011 DOUBLE GLASS RIGHT-LEFT PROFILE	2.000	PC	0B1210A1	GN1/1 DOUBLE GLASS EXT SUP-INF PROFILE	2.000	PC	0B1214A3	1011 DOUBLE GLASS LEFT-RIGHT EXT PROFILE	2.000	PC	CR1105A0	HINGES INTERNAL GLASS DOUBL	1.000	PC	CR1106A0	HINGES INTERNAL GLASS DOUBL	1.000	PC	VI1220A1	4,2x12 TCB SELF-TAPPIN G SCREW	4.000	PC	VI1225A0	STAINLESS STEEL STRUCTURE RIVET 4x10.1	20.000	PC	VT1286B0	1011 639x789x4 INNER DOUBLE GLAS	2.000	PC
Code	Description	Qty	UOM																																										
0B1180A0	GN1/1 INT DOUBLE GLASS INF-SUP BEAM	2.000	PC																																										
0B1183A0	1011 DOUBLE GLASS RIGHT-LEFT PROFILE	2.000	PC																																										
0B1210A1	GN1/1 DOUBLE GLASS EXT SUP-INF PROFILE	2.000	PC																																										
0B1214A3	1011 DOUBLE GLASS LEFT-RIGHT EXT PROFILE	2.000	PC																																										
CR1105A0	HINGES INTERNAL GLASS DOUBL	1.000	PC																																										
CR1106A0	HINGES INTERNAL GLASS DOUBL	1.000	PC																																										
VI1220A1	4,2x12 TCB SELF-TAPPIN G SCREW	4.000	PC																																										
VI1225A0	STAINLESS STEEL STRUCTURE RIVET 4x10.1	20.000	PC																																										
VT1286B0	1011 639x789x4 INNER DOUBLE GLAS	2.000	PC																																										



COMPONENT			SPARE PART														
Code	Description	Image	Code	Description	Kit components												
VM2518A	BOARD COOLING FAN SUPPORT		KVM2518A	PANEL COOLING FAN SUPPORT KIT	<table border="1"> <thead> <tr> <th>Code</th> <th>Description</th> <th>Qty</th> <th>UOM</th> </tr> </thead> <tbody> <tr> <td>VM2518A0</td> <td>BOARD COOLING FAN SUPPORT</td> <td>1.000</td> <td>PC</td> </tr> </tbody> </table>	Code	Description	Qty	UOM	VM2518A0	BOARD COOLING FAN SUPPORT	1.000	PC				
Code	Description	Qty	UOM														
VM2518A0	BOARD COOLING FAN SUPPORT	1.000	PC														
VN1179A	CONTROL BOARD 40x40x20mm 12V COOLING FAN		KVN1179A	CONTROL BOARD COOLING FAN KIT	<table border="1"> <thead> <tr> <th>Code</th> <th>Description</th> <th>Qty</th> <th>UOM</th> </tr> </thead> <tbody> <tr> <td>VN1179A1</td> <td>CONTROL BOARD 40x40x20mm 12V COOLING FAN</td> <td>1.000</td> <td>PC</td> </tr> </tbody> </table>	Code	Description	Qty	UOM	VN1179A1	CONTROL BOARD 40x40x20mm 12V COOLING FAN	1.000	PC				
Code	Description	Qty	UOM														
VN1179A1	CONTROL BOARD 40x40x20mm 12V COOLING FAN	1.000	PC														
CE1097A	4M SIHF 4 POLES MICROFIT CANBUS		KCE1097A	POWER-CONTROL 4POLES 4M BUS CABLE KIT	<table border="1"> <thead> <tr> <th>Code</th> <th>Description</th> <th>Qty</th> <th>UOM</th> </tr> </thead> <tbody> <tr> <td>CE1097A0</td> <td>4M SIHF 4 POLES MICROFIT CANBUS</td> <td>1.000</td> <td>PC</td> </tr> <tr> <td>CE1285A0</td> <td>EMI ROUND FERRITE MOD.26438015 02</td> <td>2.000</td> <td>PC</td> </tr> </tbody> </table>	Code	Description	Qty	UOM	CE1097A0	4M SIHF 4 POLES MICROFIT CANBUS	1.000	PC	CE1285A0	EMI ROUND FERRITE MOD.26438015 02	2.000	PC
Code	Description	Qty	UOM														
CE1097A0	4M SIHF 4 POLES MICROFIT CANBUS	1.000	PC														
CE1285A0	EMI ROUND FERRITE MOD.26438015 02	2.000	PC														
CE1285A	EMI ROUND FERRITE MOD.2643801502		KCE1285A	ROUND FERRITE ELECTROMAGN PROT. 2PCS KIT	<table border="1"> <thead> <tr> <th>Code</th> <th>Description</th> <th>Qty</th> <th>UOM</th> </tr> </thead> <tbody> <tr> <td>CE1285A0</td> <td>EMI ROUND FERRITE MOD.26438015 02</td> <td>2.000</td> <td>PC</td> </tr> </tbody> </table>	Code	Description	Qty	UOM	CE1285A0	EMI ROUND FERRITE MOD.26438015 02	2.000	PC				
Code	Description	Qty	UOM														
CE1285A0	EMI ROUND FERRITE MOD.26438015 02	2.000	PC														
VI1074A	4X16 SCREW FOR PLASTIC		VI1074A0	4X16 SCREW FOR PLASTIC													



COMPONENT			SPARE PART																		
Code	Description	Image	Code	Description	Kit components																
MG1091B	MM ENERGY STAR COMPLETE HANDLE		KMG1091B	MM ENERGY STAR HANDLE KIT -M	<table border="1"> <thead> <tr> <th>Code</th> <th>Description</th> <th>Qty</th> <th>UOM</th> </tr> </thead> <tbody> <tr> <td>MG1091B1</td> <td>MM ENERGY STAR COMPLETE HANDLE</td> <td>1.000</td> <td>PC</td> </tr> <tr> <td>V11074A0</td> <td>4X16 SCREW FOR PLASTIC</td> <td>4.000</td> <td>PC</td> </tr> <tr> <td>VM1490A0</td> <td>CHEFTOP/BAK ERTOP HANDLE SCREWS COVER</td> <td>2.000</td> <td>PC</td> </tr> </tbody> </table>	Code	Description	Qty	UOM	MG1091B1	MM ENERGY STAR COMPLETE HANDLE	1.000	PC	V11074A0	4X16 SCREW FOR PLASTIC	4.000	PC	VM1490A0	CHEFTOP/BAK ERTOP HANDLE SCREWS COVER	2.000	PC
					Code	Description	Qty	UOM													
					MG1091B1	MM ENERGY STAR COMPLETE HANDLE	1.000	PC													
					V11074A0	4X16 SCREW FOR PLASTIC	4.000	PC													
VM1490A0	CHEFTOP/BAK ERTOP HANDLE SCREWS COVER	2.000	PC																		
CE1052A	MM USB-CONTROL PANEL CONNECTING CABL		KCE1052A	CONTROL BOARD-USB 650 CONN. CABLE KIT	<table border="1"> <thead> <tr> <th>Code</th> <th>Description</th> <th>Qty</th> <th>UOM</th> </tr> </thead> <tbody> <tr> <td>CE1052A1</td> <td>MM USB-CONTROL L PANEL CONNECTING CABLE</td> <td>1.000</td> <td>PC</td> </tr> </tbody> </table>	Code	Description	Qty	UOM	CE1052A1	MM USB-CONTROL L PANEL CONNECTING CABLE	1.000	PC								
Code	Description	Qty	UOM																		
CE1052A1	MM USB-CONTROL L PANEL CONNECTING CABLE	1.000	PC																		
CE1053B	MM MICROFIT LED BAR POWER SUPPLY CABLE		KCE1053B	LED BAR EXTENSION CABLE KIT	<table border="1"> <thead> <tr> <th>Code</th> <th>Description</th> <th>Qty</th> <th>UOM</th> </tr> </thead> <tbody> <tr> <td>CE1053B0</td> <td>MM MICROFIT LED BAR POWER SUPPLY CABL</td> <td>1.000</td> <td>PC</td> </tr> </tbody> </table>	Code	Description	Qty	UOM	CE1053B0	MM MICROFIT LED BAR POWER SUPPLY CABL	1.000	PC								
Code	Description	Qty	UOM																		
CE1053B0	MM MICROFIT LED BAR POWER SUPPLY CABL	1.000	PC																		
LP1021A	6 SERIES L600 LED LIGHT BAR - E750		KLP1021A	L600 E750 LED LIGHT BAR KIT	<table border="1"> <thead> <tr> <th>Code</th> <th>Description</th> <th>Qty</th> <th>UOM</th> </tr> </thead> <tbody> <tr> <td>LP1021A0</td> <td>6 SERIES L600 LED LIGHT BAR - E750</td> <td>1.000</td> <td>PC</td> </tr> </tbody> </table>	Code	Description	Qty	UOM	LP1021A0	6 SERIES L600 LED LIGHT BAR - E750	1.000	PC								
Code	Description	Qty	UOM																		
LP1021A0	6 SERIES L600 LED LIGHT BAR - E750	1.000	PC																		
LP1027A	L750 MM NO LED LIGHT BAR COVER		KLP1027A	L750 MM NO LED LIGHT HOLDER KIT	<table border="1"> <thead> <tr> <th>Code</th> <th>Description</th> <th>Qty</th> <th>UOM</th> </tr> </thead> <tbody> <tr> <td>LP1027A0</td> <td>L750 MM NO LED LIGHT BAR COVER</td> <td>1.000</td> <td>PC</td> </tr> </tbody> </table>	Code	Description	Qty	UOM	LP1027A0	L750 MM NO LED LIGHT BAR COVER	1.000	PC								
Code	Description	Qty	UOM																		
LP1027A0	L750 MM NO LED LIGHT BAR COVER	1.000	PC																		



COMPONENT			SPARE PART																														
Code	Description	Image	Code	Description	Kit components																												
PE1057A	MM PLUS CAPACITIVE CONTROL PANEL		KPE1057B	MM PLUS CAPACITIVE CONTROL BOARD KIT	<table border="1"> <thead> <tr> <th>Code</th> <th>Description</th> <th>Qty</th> <th>UOM</th> </tr> </thead> <tbody> <tr> <td>CE2007A0</td> <td>4PM-MINIFIT 4PF 100mm MICROFIT CABLE</td> <td>1.000</td> <td>PC</td> </tr> <tr> <td>PE1057B0</td> <td>MM PLUS CAPACITIVE CONTROL PANEL</td> <td>1.000</td> <td>PC</td> </tr> <tr> <td>VI1074A0</td> <td>4X16 SCREW FOR PLASTIC</td> <td>2.000</td> <td>PC</td> </tr> <tr> <td>VM2295A1</td> <td>MIND.MAPS TOUCH CONTROL STYLUS</td> <td>1.000</td> <td>PC</td> </tr> <tr> <td>VP1067A0</td> <td>MM CONTROL BOARD RETROFIT SPACER</td> <td>1.000</td> <td>PC</td> </tr> <tr> <td>VP1078A0</td> <td>MM CONTROL BOARD RETROFIT FRAME</td> <td>1.000</td> <td>PC</td> </tr> </tbody> </table>	Code	Description	Qty	UOM	CE2007A0	4PM-MINIFIT 4PF 100mm MICROFIT CABLE	1.000	PC	PE1057B0	MM PLUS CAPACITIVE CONTROL PANEL	1.000	PC	VI1074A0	4X16 SCREW FOR PLASTIC	2.000	PC	VM2295A1	MIND.MAPS TOUCH CONTROL STYLUS	1.000	PC	VP1067A0	MM CONTROL BOARD RETROFIT SPACER	1.000	PC	VP1078A0	MM CONTROL BOARD RETROFIT FRAME	1.000	PC
					Code	Description	Qty	UOM																									
					CE2007A0	4PM-MINIFIT 4PF 100mm MICROFIT CABLE	1.000	PC																									
					PE1057B0	MM PLUS CAPACITIVE CONTROL PANEL	1.000	PC																									
					VI1074A0	4X16 SCREW FOR PLASTIC	2.000	PC																									
					VM2295A1	MIND.MAPS TOUCH CONTROL STYLUS	1.000	PC																									
					VP1067A0	MM CONTROL BOARD RETROFIT SPACER	1.000	PC																									
VP1078A0	MM CONTROL BOARD RETROFIT FRAME	1.000	PC																														
PE1059A	MM USB-RESET SUPPORT		KPE1059A	MM USB-RESET SUPPORT KIT	<table border="1"> <thead> <tr> <th>Code</th> <th>Description</th> <th>Qty</th> <th>UOM</th> </tr> </thead> <tbody> <tr> <td>PE1059A0</td> <td>MM USB-RESET SUPPORT</td> <td>1.000</td> <td>PC</td> </tr> <tr> <td>VI1220A1</td> <td>4.2x12 TCB SELF-TAPPIN G SCREW</td> <td>2.000</td> <td>PC</td> </tr> </tbody> </table>	Code	Description	Qty	UOM	PE1059A0	MM USB-RESET SUPPORT	1.000	PC	VI1220A1	4.2x12 TCB SELF-TAPPIN G SCREW	2.000	PC																
					Code	Description	Qty	UOM																									
PE1059A0	MM USB-RESET SUPPORT	1.000	PC																														
VI1220A1	4.2x12 TCB SELF-TAPPIN G SCREW	2.000	PC																														
VI1034A	STAINLESS STEEL WASHER 8.4x16x1		KVI1034A	STAINLESS STEEL WASHER 10 PCS KIT	<table border="1"> <thead> <tr> <th>Code</th> <th>Description</th> <th>Qty</th> <th>UOM</th> </tr> </thead> <tbody> <tr> <td>VI1034A0</td> <td>STAINLESS STEEL WASHER 8.4x16x1</td> <td>10.000</td> <td>PC</td> </tr> </tbody> </table>	Code	Description	Qty	UOM	VI1034A0	STAINLESS STEEL WASHER 8.4x16x1	10.000	PC																				
Code	Description	Qty	UOM																														
VI1034A0	STAINLESS STEEL WASHER 8.4x16x1	10.000	PC																														
VM2410A	PLATE TO STOP EXTRUDED LED BAR		KVM2410A	PLATE TO STOP EXTRUDED LED BAR 2P KIT	<table border="1"> <thead> <tr> <th>Code</th> <th>Description</th> <th>Qty</th> <th>UOM</th> </tr> </thead> <tbody> <tr> <td>0B1190A0</td> <td>PLATE TO STOP EXTRUDED LED BAR</td> <td>2.000</td> <td>PC</td> </tr> <tr> <td>VM2410A0</td> <td>PLATE TO STOP EXTRUDED LED BAR</td> <td>2.000</td> <td>PC</td> </tr> </tbody> </table>	Code	Description	Qty	UOM	0B1190A0	PLATE TO STOP EXTRUDED LED BAR	2.000	PC	VM2410A0	PLATE TO STOP EXTRUDED LED BAR	2.000	PC																
					Code	Description	Qty	UOM																									
0B1190A0	PLATE TO STOP EXTRUDED LED BAR	2.000	PC																														
VM2410A0	PLATE TO STOP EXTRUDED LED BAR	2.000	PC																														



COMPONENT			SPARE PART																																															
Code	Description	Image	Code	Description	Kit components																																													
VT1278A	EXTERNAL GLASS SER. XEVC-1011-E		KVT1278A	1011 EXTERNAL GLASS KIT	<table border="1"> <thead> <tr> <th>Code</th> <th>Description</th> <th>Qty</th> <th>UOM</th> </tr> </thead> <tbody> <tr> <td>0B1168A1</td> <td>XEVC-1011-E EXT GLASS SUPPORT PROFILE</td> <td>2.000</td> <td>PC</td> </tr> <tr> <td>SL1221A0</td> <td>GN1/1 EXTERNAL GLASS UPPER SILICONE</td> <td>1.000</td> <td>PC</td> </tr> <tr> <td>SL1226A0</td> <td>1011 EXTERNAL GLASS LATERAL SILICONE</td> <td>4.000</td> <td>PC</td> </tr> <tr> <td>VT1278A0</td> <td>EXTERNAL GLASS SER. XEVC-1011-E</td> <td>1.000</td> <td>PC</td> </tr> </tbody> </table>	Code	Description	Qty	UOM	0B1168A1	XEVC-1011-E EXT GLASS SUPPORT PROFILE	2.000	PC	SL1221A0	GN1/1 EXTERNAL GLASS UPPER SILICONE	1.000	PC	SL1226A0	1011 EXTERNAL GLASS LATERAL SILICONE	4.000	PC	VT1278A0	EXTERNAL GLASS SER. XEVC-1011-E	1.000	PC																									
			Code	Description	Qty	UOM																																												
0B1168A1	XEVC-1011-E EXT GLASS SUPPORT PROFILE	2.000	PC																																															
SL1221A0	GN1/1 EXTERNAL GLASS UPPER SILICONE	1.000	PC																																															
SL1226A0	1011 EXTERNAL GLASS LATERAL SILICONE	4.000	PC																																															
VT1278A0	EXTERNAL GLASS SER. XEVC-1011-E	1.000	PC																																															
KDR1309A	1011 ZERO -M LEFT COMPLETE DOOR KIT	<table border="1"> <thead> <tr> <th>Code</th> <th>Description</th> <th>Qty</th> <th>UOM</th> </tr> </thead> <tbody> <tr> <td>0B1122B0</td> <td>MM CT 750mm DOOR LOWER BEAM</td> <td>1.000</td> <td>PC</td> </tr> <tr> <td>0B1168A1</td> <td>XEVC-1011-E EXT GLASS SUPPORT PROFILE</td> <td>2.000</td> <td>PC</td> </tr> <tr> <td>0B1201B1</td> <td>LEFT 1011 DOOR LEFT EXT COLUMN</td> <td>1.000</td> <td>PC</td> </tr> <tr> <td>0B1202A2</td> <td>LEFT 1011 DOOR RIGHT INT COLUMN</td> <td>1.000</td> <td>PC</td> </tr> <tr> <td>0B1203A2</td> <td>LEFT 1011 DOOR LEFT INT COLUMN</td> <td>1.000</td> <td>PC</td> </tr> <tr> <td>0B1208A0</td> <td>LEFT 1011 DOOR RIGHT EXT COLUMN</td> <td>1.000</td> <td>PC</td> </tr> <tr> <td>0B1216B0</td> <td>MM DOUBLE GLASS DOOR 750mm UPPER BEAM</td> <td>1.000</td> <td>PC</td> </tr> <tr> <td>0B1217A1</td> <td>MM DOUBLE GLASS DOOR INT UPPER BEAM 750</td> <td>1.000</td> <td>PC</td> </tr> <tr> <td>0H2892A0</td> <td>LED BAR UPPER CAP PLATE</td> <td>1.000</td> <td>PC</td> </tr> <tr> <td>0H2893A0</td> <td>LED BAR LOWER CAP PLATE</td> <td>1.000</td> <td>PC</td> </tr> <tr> <td>CE1097A0</td> <td>4M SIHF 4 POLES MICROFIT CANBUS</td> <td>1.000</td> <td>PC</td> </tr> </tbody> </table>	Code	Description	Qty	UOM	0B1122B0	MM CT 750mm DOOR LOWER BEAM	1.000	PC	0B1168A1	XEVC-1011-E EXT GLASS SUPPORT PROFILE	2.000	PC	0B1201B1	LEFT 1011 DOOR LEFT EXT COLUMN	1.000	PC	0B1202A2	LEFT 1011 DOOR RIGHT INT COLUMN	1.000	PC	0B1203A2	LEFT 1011 DOOR LEFT INT COLUMN	1.000	PC	0B1208A0	LEFT 1011 DOOR RIGHT EXT COLUMN	1.000	PC	0B1216B0	MM DOUBLE GLASS DOOR 750mm UPPER BEAM	1.000	PC	0B1217A1	MM DOUBLE GLASS DOOR INT UPPER BEAM 750	1.000	PC	0H2892A0	LED BAR UPPER CAP PLATE	1.000	PC	0H2893A0	LED BAR LOWER CAP PLATE	1.000	PC	CE1097A0	4M SIHF 4 POLES MICROFIT CANBUS	1.000	PC
Code	Description	Qty	UOM																																															
0B1122B0	MM CT 750mm DOOR LOWER BEAM	1.000	PC																																															
0B1168A1	XEVC-1011-E EXT GLASS SUPPORT PROFILE	2.000	PC																																															
0B1201B1	LEFT 1011 DOOR LEFT EXT COLUMN	1.000	PC																																															
0B1202A2	LEFT 1011 DOOR RIGHT INT COLUMN	1.000	PC																																															
0B1203A2	LEFT 1011 DOOR LEFT INT COLUMN	1.000	PC																																															
0B1208A0	LEFT 1011 DOOR RIGHT EXT COLUMN	1.000	PC																																															
0B1216B0	MM DOUBLE GLASS DOOR 750mm UPPER BEAM	1.000	PC																																															
0B1217A1	MM DOUBLE GLASS DOOR INT UPPER BEAM 750	1.000	PC																																															
0H2892A0	LED BAR UPPER CAP PLATE	1.000	PC																																															
0H2893A0	LED BAR LOWER CAP PLATE	1.000	PC																																															
CE1097A0	4M SIHF 4 POLES MICROFIT CANBUS	1.000	PC																																															





COMPONENT			SPARE PART					
Code	Description	Image	Code	Description	Kit components			
VT1278A	EXTERNAL GLASS SER. XEVC-1011-E		KDR1309A	1011 ZERO -M LEFT COMPLETE DOOR KIT	Code	Description	Qty	UOM
					CE1285A0	EMI ROUND FERRITE MOD.26438015 02	2.000	PC
					CE1851A0	MICROFIT CABLE 2P M-F-F AWG22	1.000	PC
					CE2006A1	MICROFIT CABLE 2PM-400-AMP MODU2 2PF	1.000	PC
					GN1525A0	O-RING INT DIAM 9,5 THK 1 NBR 70	1.000	PC
					LP1056A0	S6 L400 E750 LED BAR	1.000	PC
					MG1099A1	MM COMPLETE HANDLE	1.000	PC
					SL1170A1	S57 BLACK SILICON - 310ml CARTRIDGE	43.000	ML
					SL1221A0	GN1/1 EXTERNAL GLASS UPPER SILICONE	1.000	PC
					SL1226A0	1011 EXTERNAL GLASS LATERAL SILICONE	4.000	PC
					VE1030A1	MAGNET FOR DOOR MICROSWITC H D=22.9mm	1.000	PC
					VI1034A0	STAINLESS STEEL WASHER 8,4x16x1	1.000	PC
					VI1074A0	4X16 SCREW FOR PLASTIC	4.000	PC
					VI1174A0		16.000	PC
					VI1220A1	4,2x12 TCB SELF-TAPPIN G SCREW	30.000	PC
VI1565A0	WASHER INTD=4.2 EXTD=20 TH=125/10 INO	1.000	PC					
VI1996A0	M5x35 SCREW	13.000	PC					



COMPONENT			SPARE PART																																																																																			
Code	Description	Image	Code	Description	Kit components																																																																																	
VT1278A	EXTERNAL GLASS SER. XEVC-1011-E		KDR1309A	1011 ZERO -M LEFT COMPLETE DOOR KIT	<table border="1"> <thead> <tr> <th>Code</th> <th>Description</th> <th>Qty</th> <th>UOM</th> </tr> </thead> <tbody> <tr> <td>VM1490A0</td> <td>CHEFTOP/BAK ERTOP HANDLE SCREWS COVER</td> <td>2.000</td> <td>PC</td> </tr> <tr> <td>VM1630A1</td> <td>INTERNAL GLASS PUSHING CAP</td> <td>5.000</td> <td>PC</td> </tr> <tr> <td>VM1631A0</td> <td>PLUS INNER GLASS PUSHING CAP</td> <td>5.000</td> <td>PC</td> </tr> <tr> <td>VM2268A0</td> <td>DOOR MAGNET COVER</td> <td>1.000</td> <td>PC</td> </tr> <tr> <td>VM2274A0</td> <td>GROOVED BUSHING</td> <td>1.000</td> <td>PC</td> </tr> <tr> <td>VM2275A0</td> <td>SMOOTH BUSHING</td> <td>1.000</td> <td>PC</td> </tr> <tr> <td>VM2284B0</td> <td>750 SERIES DRIP PROFILE KIT</td> <td>1.000</td> <td>PC</td> </tr> <tr> <td>VM2305A0</td> <td>MM SERIES DOOR CAP FIXING PAWL</td> <td>14.000</td> <td>PC</td> </tr> <tr> <td>VM2313A0</td> <td>MM DRIP TRAY RIGHT DRAIN PIPE</td> <td>1.000</td> <td>PC</td> </tr> <tr> <td>VM2314A0</td> <td>MM DRIP PROFILE CAP</td> <td>1.000</td> <td>PC</td> </tr> <tr> <td>VM2315B0</td> <td>MM - M INNER GLASS PUSHING CAP HOLDER</td> <td>5.000</td> <td>PC</td> </tr> <tr> <td>VM2384B0</td> <td>MM LEFT DOOR RIGHT LOWER CAP</td> <td>1.000</td> <td>PC</td> </tr> <tr> <td>VM2410A0</td> <td>PLATE TO STOP EXTRUDED LED BAR</td> <td>1.000</td> <td>PC</td> </tr> <tr> <td>VM2505B1</td> <td>MM PLUS INTERNAL GLASS SUPPORT</td> <td>5.000</td> <td>PC</td> </tr> <tr> <td>VM2959A0</td> <td></td> <td>1.000</td> <td>PC</td> </tr> <tr> <td>VM2960A0</td> <td></td> <td>1.000</td> <td>PC</td> </tr> <tr> <td>VM2961A0</td> <td></td> <td>1.000</td> <td>PC</td> </tr> <tr> <td>VP1081A0</td> <td>UPPER HINGE CAP FOR UPPER INNER GLASS</td> <td>1.000</td> <td>PC</td> </tr> <tr> <td>VT1278A0</td> <td>EXTERNAL GLASS SER. XEVC-1011-E</td> <td></td> <td>1.000</td> <td>PC</td> </tr> </tbody> </table>	Code	Description	Qty	UOM	VM1490A0	CHEFTOP/BAK ERTOP HANDLE SCREWS COVER	2.000	PC	VM1630A1	INTERNAL GLASS PUSHING CAP	5.000	PC	VM1631A0	PLUS INNER GLASS PUSHING CAP	5.000	PC	VM2268A0	DOOR MAGNET COVER	1.000	PC	VM2274A0	GROOVED BUSHING	1.000	PC	VM2275A0	SMOOTH BUSHING	1.000	PC	VM2284B0	750 SERIES DRIP PROFILE KIT	1.000	PC	VM2305A0	MM SERIES DOOR CAP FIXING PAWL	14.000	PC	VM2313A0	MM DRIP TRAY RIGHT DRAIN PIPE	1.000	PC	VM2314A0	MM DRIP PROFILE CAP	1.000	PC	VM2315B0	MM - M INNER GLASS PUSHING CAP HOLDER	5.000	PC	VM2384B0	MM LEFT DOOR RIGHT LOWER CAP	1.000	PC	VM2410A0	PLATE TO STOP EXTRUDED LED BAR	1.000	PC	VM2505B1	MM PLUS INTERNAL GLASS SUPPORT	5.000	PC	VM2959A0		1.000	PC	VM2960A0		1.000	PC	VM2961A0		1.000	PC	VP1081A0	UPPER HINGE CAP FOR UPPER INNER GLASS	1.000	PC	VT1278A0	EXTERNAL GLASS SER. XEVC-1011-E		1.000	PC
Code	Description	Qty	UOM																																																																																			
VM1490A0	CHEFTOP/BAK ERTOP HANDLE SCREWS COVER	2.000	PC																																																																																			
VM1630A1	INTERNAL GLASS PUSHING CAP	5.000	PC																																																																																			
VM1631A0	PLUS INNER GLASS PUSHING CAP	5.000	PC																																																																																			
VM2268A0	DOOR MAGNET COVER	1.000	PC																																																																																			
VM2274A0	GROOVED BUSHING	1.000	PC																																																																																			
VM2275A0	SMOOTH BUSHING	1.000	PC																																																																																			
VM2284B0	750 SERIES DRIP PROFILE KIT	1.000	PC																																																																																			
VM2305A0	MM SERIES DOOR CAP FIXING PAWL	14.000	PC																																																																																			
VM2313A0	MM DRIP TRAY RIGHT DRAIN PIPE	1.000	PC																																																																																			
VM2314A0	MM DRIP PROFILE CAP	1.000	PC																																																																																			
VM2315B0	MM - M INNER GLASS PUSHING CAP HOLDER	5.000	PC																																																																																			
VM2384B0	MM LEFT DOOR RIGHT LOWER CAP	1.000	PC																																																																																			
VM2410A0	PLATE TO STOP EXTRUDED LED BAR	1.000	PC																																																																																			
VM2505B1	MM PLUS INTERNAL GLASS SUPPORT	5.000	PC																																																																																			
VM2959A0		1.000	PC																																																																																			
VM2960A0		1.000	PC																																																																																			
VM2961A0		1.000	PC																																																																																			
VP1081A0	UPPER HINGE CAP FOR UPPER INNER GLASS	1.000	PC																																																																																			
VT1278A0	EXTERNAL GLASS SER. XEVC-1011-E		1.000	PC																																																																																		



COMPONENT			SPARE PART																																																																							
Code	Description	Image	Code	Description	Kit components																																																																					
VT1278A	EXTERNAL GLASS SER. XEVC-1011-E		KDR1308A	1011 ZERO -M RIGHT COMPLETE DOOR KIT	<table border="1"> <thead> <tr> <th>Code</th> <th>Description</th> <th>Qty</th> <th>UOM</th> </tr> </thead> <tbody> <tr> <td>0B1116A0</td> <td>XEVC-1011-E LEFT EXT DOOR COLUM</td> <td>1.000</td> <td>PC</td> </tr> <tr> <td>0B1117A2</td> <td>1011 RIGHT - DOOR LEFT INT COLUMN</td> <td>1.000</td> <td>PC</td> </tr> <tr> <td>0B1118B1</td> <td>XEVC-1011 DOOR RIGHT EXTERNAL COLUMN</td> <td>1.000</td> <td>PC</td> </tr> <tr> <td>0B1119A2</td> <td>1011 RIGHT - DOOR RIGHT INT COLUMN</td> <td>1.000</td> <td>PC</td> </tr> <tr> <td>0B1122B0</td> <td>MM CT 750mm DOOR LOWER BEAM</td> <td>1.000</td> <td>PC</td> </tr> <tr> <td>0B1168A1</td> <td>XEVC-1011-E EXT GLASS SUPPORT PROFILE</td> <td>2.000</td> <td>PC</td> </tr> <tr> <td>0B1216B0</td> <td>MM DOUBLE GLASS DOOR 750mm UPPER BEAM</td> <td>1.000</td> <td>PC</td> </tr> <tr> <td>0B1217A1</td> <td>MM DOUBLE GLASS DOOR INT UPPER BEAM 750</td> <td>1.000</td> <td>PC</td> </tr> <tr> <td>0H2892A0</td> <td>LED BAR UPPER CAP PLATE</td> <td>1.000</td> <td>PC</td> </tr> <tr> <td>0H2893A0</td> <td>LED BAR LOWER CAP PLATE</td> <td>1.000</td> <td>PC</td> </tr> <tr> <td>CE1097A0</td> <td>4M SIHF 4 POLES MICROFIT CANBUS</td> <td>1.000</td> <td>PC</td> </tr> <tr> <td>CE1285A0</td> <td>EMI ROUND FERRITE MOD.26438015 02</td> <td>2.000</td> <td>PC</td> </tr> <tr> <td>CE1851A0</td> <td>MICROFIT CABLE 2P M-F-F AWG22</td> <td>1.000</td> <td>PC</td> </tr> <tr> <td>CE2006A1</td> <td>MICROFIT CABLE 2PM-400-AMP MODU2 2PF</td> <td>1.000</td> <td>PC</td> </tr> <tr> <td>GN1525A0</td> <td>O-RING INT DIAM 9,5 THK 1 NBR 70</td> <td>1.000</td> <td>PC</td> </tr> <tr> <td>LP1056A0</td> <td>S6 L400 E750 LED BAR</td> <td>1.000</td> <td>PC</td> </tr> </tbody> </table>	Code	Description	Qty	UOM	0B1116A0	XEVC-1011-E LEFT EXT DOOR COLUM	1.000	PC	0B1117A2	1011 RIGHT - DOOR LEFT INT COLUMN	1.000	PC	0B1118B1	XEVC-1011 DOOR RIGHT EXTERNAL COLUMN	1.000	PC	0B1119A2	1011 RIGHT - DOOR RIGHT INT COLUMN	1.000	PC	0B1122B0	MM CT 750mm DOOR LOWER BEAM	1.000	PC	0B1168A1	XEVC-1011-E EXT GLASS SUPPORT PROFILE	2.000	PC	0B1216B0	MM DOUBLE GLASS DOOR 750mm UPPER BEAM	1.000	PC	0B1217A1	MM DOUBLE GLASS DOOR INT UPPER BEAM 750	1.000	PC	0H2892A0	LED BAR UPPER CAP PLATE	1.000	PC	0H2893A0	LED BAR LOWER CAP PLATE	1.000	PC	CE1097A0	4M SIHF 4 POLES MICROFIT CANBUS	1.000	PC	CE1285A0	EMI ROUND FERRITE MOD.26438015 02	2.000	PC	CE1851A0	MICROFIT CABLE 2P M-F-F AWG22	1.000	PC	CE2006A1	MICROFIT CABLE 2PM-400-AMP MODU2 2PF	1.000	PC	GN1525A0	O-RING INT DIAM 9,5 THK 1 NBR 70	1.000	PC	LP1056A0	S6 L400 E750 LED BAR	1.000	PC	
Code	Description	Qty	UOM																																																																							
0B1116A0	XEVC-1011-E LEFT EXT DOOR COLUM	1.000	PC																																																																							
0B1117A2	1011 RIGHT - DOOR LEFT INT COLUMN	1.000	PC																																																																							
0B1118B1	XEVC-1011 DOOR RIGHT EXTERNAL COLUMN	1.000	PC																																																																							
0B1119A2	1011 RIGHT - DOOR RIGHT INT COLUMN	1.000	PC																																																																							
0B1122B0	MM CT 750mm DOOR LOWER BEAM	1.000	PC																																																																							
0B1168A1	XEVC-1011-E EXT GLASS SUPPORT PROFILE	2.000	PC																																																																							
0B1216B0	MM DOUBLE GLASS DOOR 750mm UPPER BEAM	1.000	PC																																																																							
0B1217A1	MM DOUBLE GLASS DOOR INT UPPER BEAM 750	1.000	PC																																																																							
0H2892A0	LED BAR UPPER CAP PLATE	1.000	PC																																																																							
0H2893A0	LED BAR LOWER CAP PLATE	1.000	PC																																																																							
CE1097A0	4M SIHF 4 POLES MICROFIT CANBUS	1.000	PC																																																																							
CE1285A0	EMI ROUND FERRITE MOD.26438015 02	2.000	PC																																																																							
CE1851A0	MICROFIT CABLE 2P M-F-F AWG22	1.000	PC																																																																							
CE2006A1	MICROFIT CABLE 2PM-400-AMP MODU2 2PF	1.000	PC																																																																							
GN1525A0	O-RING INT DIAM 9,5 THK 1 NBR 70	1.000	PC																																																																							
LP1056A0	S6 L400 E750 LED BAR	1.000	PC																																																																							

COMPONENT			SPARE PART																																																																															
Code	Description	Image	Code	Description	Kit components																																																																													
VT1278A	EXTERNAL GLASS SER. XEVC-1011-E		KDR1308A	1011 ZERO -M RIGHT COMPLETE DOOR KIT	<table border="1"> <thead> <tr> <th>Code</th> <th>Description</th> <th>Qty</th> <th>UOM</th> </tr> </thead> <tbody> <tr> <td>MG1099A1</td> <td>MM COMPLETE HANDLE</td> <td>1.000</td> <td>PC</td> </tr> <tr> <td>SL1170A1</td> <td>S57 BLACK SILICON - 310ml CARTRIDGE</td> <td>43.000</td> <td>ML</td> </tr> <tr> <td>SL1221A0</td> <td>GN1/1 EXTERNAL GLASS UPPER SILICONE</td> <td>1.000</td> <td>PC</td> </tr> <tr> <td>SL1226A0</td> <td>1011 EXTERNAL GLASS LATERAL SILICONE</td> <td>4.000</td> <td>PC</td> </tr> <tr> <td>VE1030A1</td> <td>MAGNET FOR DOOR MICROSWITC H D=22,9mm</td> <td>1.000</td> <td>PC</td> </tr> <tr> <td>VI1034A0</td> <td>STAINLESS STEEL WASHER 8,4x16x1</td> <td>1.000</td> <td>PC</td> </tr> <tr> <td>VI1074A0</td> <td>4X16 SCREW FOR PLASTIC</td> <td>4.000</td> <td>PC</td> </tr> <tr> <td>VI1174A0</td> <td></td> <td>16.000</td> <td>PC</td> </tr> <tr> <td>VI1220A1</td> <td>4,2x12 TCB SELF-TAPPIN G SCREW</td> <td>30.000</td> <td>PC</td> </tr> <tr> <td>VI1565A0</td> <td>WASHER INTD=4.2 EXTD=20 TH=125/10 INO</td> <td>1.000</td> <td>PC</td> </tr> <tr> <td>VI1996A0</td> <td>M5x35 SCREW</td> <td>13.000</td> <td>PC</td> </tr> <tr> <td>VM1490A0</td> <td>CHEFTOP/BAK ERTOP HANDLE SCREWS COVER</td> <td>2.000</td> <td>PC</td> </tr> <tr> <td>VM1630A1</td> <td>INTERNAL GLASS PUSHING CAP</td> <td>5.000</td> <td>PC</td> </tr> <tr> <td>VM1631A0</td> <td>PLUS INNER GLASS PUSHING CAP</td> <td>5.000</td> <td>PC</td> </tr> <tr> <td>VM2259B0</td> <td>VM2259B0</td> <td>1.000</td> <td>PC</td> </tr> <tr> <td>VM2268A0</td> <td>DOOR MAGNET COVER</td> <td>1.000</td> <td>PC</td> </tr> <tr> <td>VM2274A0</td> <td>GROOVED BUSHING</td> <td>1.000</td> <td>PC</td> </tr> <tr> <td>VM2275A0</td> <td>SMOOTH BUSHING</td> <td>1.000</td> <td>PC</td> </tr> </tbody> </table>	Code	Description	Qty	UOM	MG1099A1	MM COMPLETE HANDLE	1.000	PC	SL1170A1	S57 BLACK SILICON - 310ml CARTRIDGE	43.000	ML	SL1221A0	GN1/1 EXTERNAL GLASS UPPER SILICONE	1.000	PC	SL1226A0	1011 EXTERNAL GLASS LATERAL SILICONE	4.000	PC	VE1030A1	MAGNET FOR DOOR MICROSWITC H D=22,9mm	1.000	PC	VI1034A0	STAINLESS STEEL WASHER 8,4x16x1	1.000	PC	VI1074A0	4X16 SCREW FOR PLASTIC	4.000	PC	VI1174A0		16.000	PC	VI1220A1	4,2x12 TCB SELF-TAPPIN G SCREW	30.000	PC	VI1565A0	WASHER INTD=4.2 EXTD=20 TH=125/10 INO	1.000	PC	VI1996A0	M5x35 SCREW	13.000	PC	VM1490A0	CHEFTOP/BAK ERTOP HANDLE SCREWS COVER	2.000	PC	VM1630A1	INTERNAL GLASS PUSHING CAP	5.000	PC	VM1631A0	PLUS INNER GLASS PUSHING CAP	5.000	PC	VM2259B0	VM2259B0	1.000	PC	VM2268A0	DOOR MAGNET COVER	1.000	PC	VM2274A0	GROOVED BUSHING	1.000	PC	VM2275A0	SMOOTH BUSHING	1.000	PC	
Code	Description	Qty	UOM																																																																															
MG1099A1	MM COMPLETE HANDLE	1.000	PC																																																																															
SL1170A1	S57 BLACK SILICON - 310ml CARTRIDGE	43.000	ML																																																																															
SL1221A0	GN1/1 EXTERNAL GLASS UPPER SILICONE	1.000	PC																																																																															
SL1226A0	1011 EXTERNAL GLASS LATERAL SILICONE	4.000	PC																																																																															
VE1030A1	MAGNET FOR DOOR MICROSWITC H D=22,9mm	1.000	PC																																																																															
VI1034A0	STAINLESS STEEL WASHER 8,4x16x1	1.000	PC																																																																															
VI1074A0	4X16 SCREW FOR PLASTIC	4.000	PC																																																																															
VI1174A0		16.000	PC																																																																															
VI1220A1	4,2x12 TCB SELF-TAPPIN G SCREW	30.000	PC																																																																															
VI1565A0	WASHER INTD=4.2 EXTD=20 TH=125/10 INO	1.000	PC																																																																															
VI1996A0	M5x35 SCREW	13.000	PC																																																																															
VM1490A0	CHEFTOP/BAK ERTOP HANDLE SCREWS COVER	2.000	PC																																																																															
VM1630A1	INTERNAL GLASS PUSHING CAP	5.000	PC																																																																															
VM1631A0	PLUS INNER GLASS PUSHING CAP	5.000	PC																																																																															
VM2259B0	VM2259B0	1.000	PC																																																																															
VM2268A0	DOOR MAGNET COVER	1.000	PC																																																																															
VM2274A0	GROOVED BUSHING	1.000	PC																																																																															
VM2275A0	SMOOTH BUSHING	1.000	PC																																																																															



COMPONENT			SPARE PART																																																																																	
Code	Description	Image	Code	Description	Kit components																																																																															
VT1278A	EXTERNAL GLASS SER. XEVC-1011-E		KDR1308A	1011 ZERO -M RIGHT COMPLETE DOOR KIT	<table border="1"> <thead> <tr> <th>Code</th> <th>Description</th> <th>Qty</th> <th>UOM</th> </tr> </thead> <tbody> <tr> <td>VM2284B0</td> <td>750 SERIES DRIP PROFILE KIT</td> <td>1.000</td> <td>PC</td> </tr> <tr> <td>VM2305A0</td> <td>MM SERIES DOOR CAP FIXING PAWL</td> <td>14.000</td> <td>PC</td> </tr> <tr> <td>VM2312A0</td> <td>MM DRIP PROFILE DRAIN LEFT PIPE</td> <td>1.000</td> <td>PC</td> </tr> <tr> <td>VM2314A0</td> <td>MM DRIP PROFILE CAP</td> <td>1.000</td> <td>PC</td> </tr> <tr> <td>VM2315B0</td> <td>MM - M INNER GLASS PUSHING CAP HOLDER</td> <td>5.000</td> <td>PC</td> </tr> <tr> <td>VM2410A0</td> <td>PLATE TO STOP EXTRUDED LED BAR</td> <td>1.000</td> <td>PC</td> </tr> <tr> <td>VM2505B1</td> <td>MM PLUS INTERNAL GLASS SUPPORT</td> <td>5.000</td> <td>PC</td> </tr> <tr> <td>VM2956A0</td> <td></td> <td>1.000</td> <td>PC</td> </tr> <tr> <td>VM2957A0</td> <td></td> <td>1.000</td> <td>PC</td> </tr> <tr> <td>VM2958A0</td> <td>MM - M DOOR LEFT UPPPER CAP ASSEMBL</td> <td>1.000</td> <td>PC</td> </tr> <tr> <td>VP1080A0</td> <td>UPPER HINGE CAP FOR LOWER INNER GLASS</td> <td>1.000</td> <td>PC</td> </tr> <tr> <td>VT1278A0</td> <td>EXTERNAL GLASS SER. XEVC-1011-E</td> <td>1.000</td> <td>PC</td> </tr> </tbody> </table>	Code	Description	Qty	UOM	VM2284B0	750 SERIES DRIP PROFILE KIT	1.000	PC	VM2305A0	MM SERIES DOOR CAP FIXING PAWL	14.000	PC	VM2312A0	MM DRIP PROFILE DRAIN LEFT PIPE	1.000	PC	VM2314A0	MM DRIP PROFILE CAP	1.000	PC	VM2315B0	MM - M INNER GLASS PUSHING CAP HOLDER	5.000	PC	VM2410A0	PLATE TO STOP EXTRUDED LED BAR	1.000	PC	VM2505B1	MM PLUS INTERNAL GLASS SUPPORT	5.000	PC	VM2956A0		1.000	PC	VM2957A0		1.000	PC	VM2958A0	MM - M DOOR LEFT UPPPER CAP ASSEMBL	1.000	PC	VP1080A0	UPPER HINGE CAP FOR LOWER INNER GLASS	1.000	PC	VT1278A0	EXTERNAL GLASS SER. XEVC-1011-E	1.000	PC	KDR1267B	1011 -M LEFT EXTERNAL DOOR	<table border="1"> <thead> <tr> <th>Code</th> <th>Description</th> <th>Qty</th> <th>UOM</th> </tr> </thead> <tbody> <tr> <td>0B1122B0</td> <td>MM CT 750mm DOOR LOWER BEAM</td> <td>1.000</td> <td>PC</td> </tr> <tr> <td>0B1168A1</td> <td>XEVC-1011-E EXT GLASS SUPPORT PROFILE</td> <td>2.000</td> <td>PC</td> </tr> <tr> <td>0B1201B1</td> <td>LEFT 1011 DOOR LEFT EXT COLUMN</td> <td>1.000</td> <td>PC</td> </tr> <tr> <td>0B1202A2</td> <td>LEFT 1011 DOOR RIGHT INT COLUMN</td> <td>1.000</td> <td>PC</td> </tr> <tr> <td>0B1203A2</td> <td>LEFT 1011 DOOR LEFT INT COLUMN</td> <td>1.000</td> <td>PC</td> </tr> </tbody> </table>	Code	Description	Qty	UOM	0B1122B0	MM CT 750mm DOOR LOWER BEAM	1.000	PC	0B1168A1	XEVC-1011-E EXT GLASS SUPPORT PROFILE	2.000	PC	0B1201B1	LEFT 1011 DOOR LEFT EXT COLUMN	1.000	PC	0B1202A2	LEFT 1011 DOOR RIGHT INT COLUMN	1.000	PC	0B1203A2	LEFT 1011 DOOR LEFT INT COLUMN	1.000	PC
			Code	Description	Qty	UOM																																																																														
VM2284B0	750 SERIES DRIP PROFILE KIT	1.000	PC																																																																																	
VM2305A0	MM SERIES DOOR CAP FIXING PAWL	14.000	PC																																																																																	
VM2312A0	MM DRIP PROFILE DRAIN LEFT PIPE	1.000	PC																																																																																	
VM2314A0	MM DRIP PROFILE CAP	1.000	PC																																																																																	
VM2315B0	MM - M INNER GLASS PUSHING CAP HOLDER	5.000	PC																																																																																	
VM2410A0	PLATE TO STOP EXTRUDED LED BAR	1.000	PC																																																																																	
VM2505B1	MM PLUS INTERNAL GLASS SUPPORT	5.000	PC																																																																																	
VM2956A0		1.000	PC																																																																																	
VM2957A0		1.000	PC																																																																																	
VM2958A0	MM - M DOOR LEFT UPPPER CAP ASSEMBL	1.000	PC																																																																																	
VP1080A0	UPPER HINGE CAP FOR LOWER INNER GLASS	1.000	PC																																																																																	
VT1278A0	EXTERNAL GLASS SER. XEVC-1011-E	1.000	PC																																																																																	
Code	Description	Qty	UOM																																																																																	
0B1122B0	MM CT 750mm DOOR LOWER BEAM	1.000	PC																																																																																	
0B1168A1	XEVC-1011-E EXT GLASS SUPPORT PROFILE	2.000	PC																																																																																	
0B1201B1	LEFT 1011 DOOR LEFT EXT COLUMN	1.000	PC																																																																																	
0B1202A2	LEFT 1011 DOOR RIGHT INT COLUMN	1.000	PC																																																																																	
0B1203A2	LEFT 1011 DOOR LEFT INT COLUMN	1.000	PC																																																																																	



COMPONENT			SPARE PART																																																														
Code	Description	Image	Code	Description	Kit components																																																												
VT1278A	EXTERNAL GLASS SER. XEVC-1011-E		KDR1267B	1011 -M LEFT EXTERNAL DOOR	<table border="1"> <thead> <tr> <th>Code</th> <th>Description</th> <th>Qty</th> <th>UOM</th> </tr> </thead> <tbody> <tr> <td>0B1208A0</td> <td>LEFT 1011 DOOR RIGHT EXT COLUMN</td> <td>1.000</td> <td>PC</td> </tr> <tr> <td>0B1216B0</td> <td>MM DOUBLE GLASS DOOR 750mm UPPER BEAM</td> <td>1.000</td> <td>PC</td> </tr> <tr> <td>0B1217A1</td> <td>MM DOUBLE GLASS DOOR INT UPPER BEAM 750</td> <td>1.000</td> <td>PC</td> </tr> <tr> <td>CE1052A1</td> <td>MM USB-CONTRO L PANEL CONNECTING CABLE</td> <td>1.000</td> <td>PC</td> </tr> <tr> <td>CE1053B0</td> <td>MM MICROFIT LED BAR POWER SUPPLY CABL</td> <td>1.000</td> <td>PC</td> </tr> <tr> <td>CE1097A0</td> <td>4M SIHF 4 POLES MICROFIT CANBUS</td> <td>1.000</td> <td>PC</td> </tr> <tr> <td>CE1285A0</td> <td>EMI ROUND FERRITE MOD.26438015 02</td> <td>2.000</td> <td>PC</td> </tr> <tr> <td>GN1525A0</td> <td>O-RING INT DIAM 9,5 THK 1 NBR 70</td> <td>1.000</td> <td>PC</td> </tr> <tr> <td>LP1021A0</td> <td>6 SERIES L600 LED LIGHT BAR - E750</td> <td>1.000</td> <td>PC</td> </tr> <tr> <td>LP1027A0</td> <td>L750 MM NO LED LIGHT BAR COVER</td> <td>1.000</td> <td>PC</td> </tr> <tr> <td>MG1099A1</td> <td>MM COMPLETE HANDLE</td> <td>1.000</td> <td>PC</td> </tr> <tr> <td>SL1170A1</td> <td>S57 BLACK SILICON - 310ml CARTRIDGE</td> <td>43.000</td> <td>ML</td> </tr> <tr> <td>SL1221A0</td> <td>GN1/1 EXTERNAL GLASS UPPER SILICONE</td> <td>1.000</td> <td>PC</td> </tr> <tr> <td>SL1226A0</td> <td>1011 EXTERNAL GLASS LATERAL SILICONE</td> <td>4.000</td> <td>PC</td> </tr> </tbody> </table>	Code	Description	Qty	UOM	0B1208A0	LEFT 1011 DOOR RIGHT EXT COLUMN	1.000	PC	0B1216B0	MM DOUBLE GLASS DOOR 750mm UPPER BEAM	1.000	PC	0B1217A1	MM DOUBLE GLASS DOOR INT UPPER BEAM 750	1.000	PC	CE1052A1	MM USB-CONTRO L PANEL CONNECTING CABLE	1.000	PC	CE1053B0	MM MICROFIT LED BAR POWER SUPPLY CABL	1.000	PC	CE1097A0	4M SIHF 4 POLES MICROFIT CANBUS	1.000	PC	CE1285A0	EMI ROUND FERRITE MOD.26438015 02	2.000	PC	GN1525A0	O-RING INT DIAM 9,5 THK 1 NBR 70	1.000	PC	LP1021A0	6 SERIES L600 LED LIGHT BAR - E750	1.000	PC	LP1027A0	L750 MM NO LED LIGHT BAR COVER	1.000	PC	MG1099A1	MM COMPLETE HANDLE	1.000	PC	SL1170A1	S57 BLACK SILICON - 310ml CARTRIDGE	43.000	ML	SL1221A0	GN1/1 EXTERNAL GLASS UPPER SILICONE	1.000	PC	SL1226A0	1011 EXTERNAL GLASS LATERAL SILICONE	4.000	PC
Code	Description	Qty	UOM																																																														
0B1208A0	LEFT 1011 DOOR RIGHT EXT COLUMN	1.000	PC																																																														
0B1216B0	MM DOUBLE GLASS DOOR 750mm UPPER BEAM	1.000	PC																																																														
0B1217A1	MM DOUBLE GLASS DOOR INT UPPER BEAM 750	1.000	PC																																																														
CE1052A1	MM USB-CONTRO L PANEL CONNECTING CABLE	1.000	PC																																																														
CE1053B0	MM MICROFIT LED BAR POWER SUPPLY CABL	1.000	PC																																																														
CE1097A0	4M SIHF 4 POLES MICROFIT CANBUS	1.000	PC																																																														
CE1285A0	EMI ROUND FERRITE MOD.26438015 02	2.000	PC																																																														
GN1525A0	O-RING INT DIAM 9,5 THK 1 NBR 70	1.000	PC																																																														
LP1021A0	6 SERIES L600 LED LIGHT BAR - E750	1.000	PC																																																														
LP1027A0	L750 MM NO LED LIGHT BAR COVER	1.000	PC																																																														
MG1099A1	MM COMPLETE HANDLE	1.000	PC																																																														
SL1170A1	S57 BLACK SILICON - 310ml CARTRIDGE	43.000	ML																																																														
SL1221A0	GN1/1 EXTERNAL GLASS UPPER SILICONE	1.000	PC																																																														
SL1226A0	1011 EXTERNAL GLASS LATERAL SILICONE	4.000	PC																																																														



COMPONENT			SPARE PART																																																																																		
Code	Description	Image	Code	Description	Kit components																																																																																
VT1278A	EXTERNAL GLASS SER. XEVC-1011-E		KDR1267B	1011 -M LEFT EXTERNAL DOOR	<table border="1"> <thead> <tr> <th>Code</th> <th>Description</th> <th>Qty</th> <th>UOM</th> </tr> </thead> <tbody> <tr> <td>VE1030A1</td> <td>MAGNET FOR DOOR MICROSWITC H D=22.9mm</td> <td>1.000</td> <td>PC</td> </tr> <tr> <td>VI1034A0</td> <td>STAINLESS STEEL WASHER 8.4x16x1</td> <td>1.000</td> <td>PC</td> </tr> <tr> <td>VI1074A0</td> <td>4X16 SCREW FOR PLASTIC</td> <td>4.000</td> <td>PC</td> </tr> <tr> <td>VI1174A0</td> <td></td> <td>16.000</td> <td>PC</td> </tr> <tr> <td>VI1220A1</td> <td>4,2x12 TCB SELF-TAPPIN G SCREW</td> <td>30.000</td> <td>PC</td> </tr> <tr> <td>VI1996A0</td> <td>M5x35 SCREW</td> <td>13.000</td> <td>PC</td> </tr> <tr> <td>VM1490A0</td> <td>CHEFTOP/BAK ERTOP HANDLE SCREWS COVER</td> <td>2.000</td> <td>PC</td> </tr> <tr> <td>VM1630A1</td> <td>INTERNAL GLASS PUSHING CAP</td> <td>5.000</td> <td>PC</td> </tr> <tr> <td>VM1631A0</td> <td>PLUS INNER GLASS PUSHING CAP</td> <td>5.000</td> <td>PC</td> </tr> <tr> <td>VM2268A0</td> <td>DOOR MAGNET COVER</td> <td>1.000</td> <td>PC</td> </tr> <tr> <td>VM2274A0</td> <td>GROOVED BUSHING</td> <td>1.000</td> <td>PC</td> </tr> <tr> <td>VM2275A0</td> <td>SMOOTH BUSHING</td> <td>1.000</td> <td>PC</td> </tr> <tr> <td>VM2284B0</td> <td>750 SERIES DRIP PROFILE KIT</td> <td>1.000</td> <td>PC</td> </tr> <tr> <td>VM2305A0</td> <td>MM SERIES DOOR CAP FIXING PAWL</td> <td>14.000</td> <td>PC</td> </tr> <tr> <td>VM2313A0</td> <td>MM DRIP TRAY RIGHT DRAIN PIPE</td> <td>1.000</td> <td>PC</td> </tr> <tr> <td>VM2314A0</td> <td>MM DRIP PROFILE CAP</td> <td>1.000</td> <td>PC</td> </tr> <tr> <td>VM2315B0</td> <td>MM - M INNER GLASS PUSHING CAP HOLDER</td> <td>5.000</td> <td>PC</td> </tr> <tr> <td>VM2384B0</td> <td>MM LEFT DOOR RIGHT LOWER CAP</td> <td>1.000</td> <td>PC</td> </tr> <tr> <td>VM2410A0</td> <td>PLATE TO STOP EXTRUDED LED BAR</td> <td>2.000</td> <td>PC</td> </tr> </tbody> </table>	Code	Description	Qty	UOM	VE1030A1	MAGNET FOR DOOR MICROSWITC H D=22.9mm	1.000	PC	VI1034A0	STAINLESS STEEL WASHER 8.4x16x1	1.000	PC	VI1074A0	4X16 SCREW FOR PLASTIC	4.000	PC	VI1174A0		16.000	PC	VI1220A1	4,2x12 TCB SELF-TAPPIN G SCREW	30.000	PC	VI1996A0	M5x35 SCREW	13.000	PC	VM1490A0	CHEFTOP/BAK ERTOP HANDLE SCREWS COVER	2.000	PC	VM1630A1	INTERNAL GLASS PUSHING CAP	5.000	PC	VM1631A0	PLUS INNER GLASS PUSHING CAP	5.000	PC	VM2268A0	DOOR MAGNET COVER	1.000	PC	VM2274A0	GROOVED BUSHING	1.000	PC	VM2275A0	SMOOTH BUSHING	1.000	PC	VM2284B0	750 SERIES DRIP PROFILE KIT	1.000	PC	VM2305A0	MM SERIES DOOR CAP FIXING PAWL	14.000	PC	VM2313A0	MM DRIP TRAY RIGHT DRAIN PIPE	1.000	PC	VM2314A0	MM DRIP PROFILE CAP	1.000	PC	VM2315B0	MM - M INNER GLASS PUSHING CAP HOLDER	5.000	PC	VM2384B0	MM LEFT DOOR RIGHT LOWER CAP	1.000	PC	VM2410A0	PLATE TO STOP EXTRUDED LED BAR	2.000	PC
Code	Description	Qty	UOM																																																																																		
VE1030A1	MAGNET FOR DOOR MICROSWITC H D=22.9mm	1.000	PC																																																																																		
VI1034A0	STAINLESS STEEL WASHER 8.4x16x1	1.000	PC																																																																																		
VI1074A0	4X16 SCREW FOR PLASTIC	4.000	PC																																																																																		
VI1174A0		16.000	PC																																																																																		
VI1220A1	4,2x12 TCB SELF-TAPPIN G SCREW	30.000	PC																																																																																		
VI1996A0	M5x35 SCREW	13.000	PC																																																																																		
VM1490A0	CHEFTOP/BAK ERTOP HANDLE SCREWS COVER	2.000	PC																																																																																		
VM1630A1	INTERNAL GLASS PUSHING CAP	5.000	PC																																																																																		
VM1631A0	PLUS INNER GLASS PUSHING CAP	5.000	PC																																																																																		
VM2268A0	DOOR MAGNET COVER	1.000	PC																																																																																		
VM2274A0	GROOVED BUSHING	1.000	PC																																																																																		
VM2275A0	SMOOTH BUSHING	1.000	PC																																																																																		
VM2284B0	750 SERIES DRIP PROFILE KIT	1.000	PC																																																																																		
VM2305A0	MM SERIES DOOR CAP FIXING PAWL	14.000	PC																																																																																		
VM2313A0	MM DRIP TRAY RIGHT DRAIN PIPE	1.000	PC																																																																																		
VM2314A0	MM DRIP PROFILE CAP	1.000	PC																																																																																		
VM2315B0	MM - M INNER GLASS PUSHING CAP HOLDER	5.000	PC																																																																																		
VM2384B0	MM LEFT DOOR RIGHT LOWER CAP	1.000	PC																																																																																		
VM2410A0	PLATE TO STOP EXTRUDED LED BAR	2.000	PC																																																																																		



COMPONENT			SPARE PART																																															
Code	Description	Image	Code	Description	Kit components																																													
VT1278A	EXTERNAL GLASS SER. XEVC-1011-E		KDR1267B	1011 -M LEFT EXTERNAL DOOR	<table border="1"> <thead> <tr> <th>Code</th> <th>Description</th> <th>Qty</th> <th>UOM</th> </tr> </thead> <tbody> <tr> <td>VM2505B1</td> <td>MM PLUS INTERNAL GLASS SUPPORT</td> <td>5.000</td> <td>PC</td> </tr> <tr> <td>VM3012A0</td> <td></td> <td>1.000</td> <td>PC</td> </tr> <tr> <td>VM3013A0</td> <td></td> <td>1.000</td> <td>PC</td> </tr> <tr> <td>VM3014A0</td> <td></td> <td>1.000</td> <td>PC</td> </tr> <tr> <td>VP1081A0</td> <td>UPPER HINGE CAP FOR UPPER INNER GLASS</td> <td>1.000</td> <td>PC</td> </tr> <tr> <td>VT1278A0</td> <td>EXTERNAL GLASS SER. XEVC-1011-E</td> <td>1.000</td> <td>PC</td> </tr> </tbody> </table>	Code	Description	Qty	UOM	VM2505B1	MM PLUS INTERNAL GLASS SUPPORT	5.000	PC	VM3012A0		1.000	PC	VM3013A0		1.000	PC	VM3014A0		1.000	PC	VP1081A0	UPPER HINGE CAP FOR UPPER INNER GLASS	1.000	PC	VT1278A0	EXTERNAL GLASS SER. XEVC-1011-E	1.000	PC																	
			Code	Description	Qty	UOM																																												
VM2505B1	MM PLUS INTERNAL GLASS SUPPORT	5.000	PC																																															
VM3012A0		1.000	PC																																															
VM3013A0		1.000	PC																																															
VM3014A0		1.000	PC																																															
VP1081A0	UPPER HINGE CAP FOR UPPER INNER GLASS	1.000	PC																																															
VT1278A0	EXTERNAL GLASS SER. XEVC-1011-E	1.000	PC																																															
KDR1267A	1011 LEFT EXTERNAL DOOR	<table border="1"> <thead> <tr> <th>Code</th> <th>Description</th> <th>Qty</th> <th>UOM</th> </tr> </thead> <tbody> <tr> <td>0B1122A1</td> <td>750MM DOOR LOWER FRAME SHAPE</td> <td>1.000</td> <td>PC</td> </tr> <tr> <td>0B1168A1</td> <td>XEVC-1011-E EXT GLASS SUPPORT PROFILE</td> <td>2.000</td> <td>PC</td> </tr> <tr> <td>0B1201B1</td> <td>LEFT 1011 DOOR LEFT EXT COLUMN</td> <td>1.000</td> <td>PC</td> </tr> <tr> <td>0B1202A2</td> <td>LEFT 1011 DOOR RIGHT INT COLUMN</td> <td>1.000</td> <td>PC</td> </tr> <tr> <td>0B1203A2</td> <td>LEFT 1011 DOOR LEFT INT COLUMN</td> <td>1.000</td> <td>PC</td> </tr> <tr> <td>0B1208A0</td> <td>LEFT 1011 DOOR RIGHT EXT COLUMN</td> <td>1.000</td> <td>PC</td> </tr> <tr> <td>0B1216A1</td> <td>MM CT DOUBLE GLASS DOOR UPPER BEAM</td> <td>1.000</td> <td>PC</td> </tr> <tr> <td>0B1217A1</td> <td>MM DOUBLE GLASS DOOR INT UPPER BEAM 750</td> <td>1.000</td> <td>PC</td> </tr> <tr> <td>CE1052A1</td> <td>MM USB-CONTRO L PANEL CONNECTING CABLE</td> <td>1.000</td> <td>PC</td> </tr> <tr> <td>CE1053B0</td> <td>MM MICROFIT LED BAR POWER SUPPLY CABL</td> <td>1.000</td> <td>PC</td> </tr> <tr> <td>CE1285A0</td> <td>EMI ROUND FERRITE MOD.26438015 02</td> <td>1.000</td> <td>PC</td> </tr> </tbody> </table>	Code	Description	Qty	UOM	0B1122A1	750MM DOOR LOWER FRAME SHAPE	1.000	PC	0B1168A1	XEVC-1011-E EXT GLASS SUPPORT PROFILE	2.000	PC	0B1201B1	LEFT 1011 DOOR LEFT EXT COLUMN	1.000	PC	0B1202A2	LEFT 1011 DOOR RIGHT INT COLUMN	1.000	PC	0B1203A2	LEFT 1011 DOOR LEFT INT COLUMN	1.000	PC	0B1208A0	LEFT 1011 DOOR RIGHT EXT COLUMN	1.000	PC	0B1216A1	MM CT DOUBLE GLASS DOOR UPPER BEAM	1.000	PC	0B1217A1	MM DOUBLE GLASS DOOR INT UPPER BEAM 750	1.000	PC	CE1052A1	MM USB-CONTRO L PANEL CONNECTING CABLE	1.000	PC	CE1053B0	MM MICROFIT LED BAR POWER SUPPLY CABL	1.000	PC	CE1285A0	EMI ROUND FERRITE MOD.26438015 02	1.000	PC
Code	Description	Qty	UOM																																															
0B1122A1	750MM DOOR LOWER FRAME SHAPE	1.000	PC																																															
0B1168A1	XEVC-1011-E EXT GLASS SUPPORT PROFILE	2.000	PC																																															
0B1201B1	LEFT 1011 DOOR LEFT EXT COLUMN	1.000	PC																																															
0B1202A2	LEFT 1011 DOOR RIGHT INT COLUMN	1.000	PC																																															
0B1203A2	LEFT 1011 DOOR LEFT INT COLUMN	1.000	PC																																															
0B1208A0	LEFT 1011 DOOR RIGHT EXT COLUMN	1.000	PC																																															
0B1216A1	MM CT DOUBLE GLASS DOOR UPPER BEAM	1.000	PC																																															
0B1217A1	MM DOUBLE GLASS DOOR INT UPPER BEAM 750	1.000	PC																																															
CE1052A1	MM USB-CONTRO L PANEL CONNECTING CABLE	1.000	PC																																															
CE1053B0	MM MICROFIT LED BAR POWER SUPPLY CABL	1.000	PC																																															
CE1285A0	EMI ROUND FERRITE MOD.26438015 02	1.000	PC																																															



COMPONENT			SPARE PART																																																																										
Code	Description	Image	Code	Description	Kit components																																																																								
VT1278A	EXTERNAL GLASS SER. XEVC-1011-E		KDR1267A	1011 LEFT EXTERNAL DOOR	<table border="1"> <thead> <tr> <th>Code</th> <th>Description</th> <th>Qty</th> <th>UOM</th> </tr> </thead> <tbody> <tr> <td>CE1290A0</td> <td>EXTRACTABL E FEMALE TERMINAL CPF 5/4</td> <td>1.000</td> <td>PC</td> </tr> <tr> <td>CE1310A1</td> <td>POWER - CONTROL BOARD CONNECTING CABLE</td> <td>1.000</td> <td>PC</td> </tr> <tr> <td>GN1525A0</td> <td>O-RING INT DIAM 9,5 THK 1 NBR 70</td> <td>1.000</td> <td>PC</td> </tr> <tr> <td>LP1021A0</td> <td>6 SERIES L600 LED LIGHT BAR - E750</td> <td>1.000</td> <td>PC</td> </tr> <tr> <td>LP1027A0</td> <td>L750 MM NO LED LIGHT BAR COVER</td> <td>1.000</td> <td>PC</td> </tr> <tr> <td>MG1083A2</td> <td>MM COMPLETE HANDLE</td> <td>1.000</td> <td>PC</td> </tr> <tr> <td>SL1170A1</td> <td>S57 BLACK SILICON - 310ml CARTRIDGE</td> <td>43.000</td> <td>ML</td> </tr> <tr> <td>VE1030A1</td> <td>MAGNET FOR DOOR MICROSWITC H D=22,9mm</td> <td>1.000</td> <td>PC</td> </tr> <tr> <td>VI1034A0</td> <td>STAINLESS STEEL WASHER 8,4x16x1</td> <td>1.000</td> <td>PC</td> </tr> <tr> <td>VI1147A0</td> <td>5X25 STAINLESS STEEL SCREW</td> <td>16.000</td> <td>PC</td> </tr> <tr> <td>VI1220A1</td> <td>4,2x12 TCB SELF-TAPPIN G SCREW</td> <td>21.000</td> <td>PC</td> </tr> <tr> <td>VI1996A0</td> <td>M5x35 SCREW</td> <td>13.000</td> <td>PC</td> </tr> <tr> <td>VM1630A1</td> <td>INTERNAL GLASS PUSHING CAP</td> <td>1.000</td> <td>PC</td> </tr> <tr> <td>VM1631A0</td> <td>PLUS INNER GLASS PUSHING CAP</td> <td>3.000</td> <td>PC</td> </tr> <tr> <td>VM2260A1</td> <td>6 SERIES DOOR UPPER LEFT CAP</td> <td>1.000</td> <td>PC</td> </tr> <tr> <td>VM2267A1</td> <td></td> <td>2.000</td> <td>PC</td> </tr> <tr> <td>VM2268A0</td> <td>DOOR MAGNET COVER</td> <td>2.000</td> <td>PC</td> </tr> </tbody> </table>	Code	Description	Qty	UOM	CE1290A0	EXTRACTABL E FEMALE TERMINAL CPF 5/4	1.000	PC	CE1310A1	POWER - CONTROL BOARD CONNECTING CABLE	1.000	PC	GN1525A0	O-RING INT DIAM 9,5 THK 1 NBR 70	1.000	PC	LP1021A0	6 SERIES L600 LED LIGHT BAR - E750	1.000	PC	LP1027A0	L750 MM NO LED LIGHT BAR COVER	1.000	PC	MG1083A2	MM COMPLETE HANDLE	1.000	PC	SL1170A1	S57 BLACK SILICON - 310ml CARTRIDGE	43.000	ML	VE1030A1	MAGNET FOR DOOR MICROSWITC H D=22,9mm	1.000	PC	VI1034A0	STAINLESS STEEL WASHER 8,4x16x1	1.000	PC	VI1147A0	5X25 STAINLESS STEEL SCREW	16.000	PC	VI1220A1	4,2x12 TCB SELF-TAPPIN G SCREW	21.000	PC	VI1996A0	M5x35 SCREW	13.000	PC	VM1630A1	INTERNAL GLASS PUSHING CAP	1.000	PC	VM1631A0	PLUS INNER GLASS PUSHING CAP	3.000	PC	VM2260A1	6 SERIES DOOR UPPER LEFT CAP	1.000	PC	VM2267A1		2.000	PC	VM2268A0	DOOR MAGNET COVER	2.000	PC
Code	Description	Qty	UOM																																																																										
CE1290A0	EXTRACTABL E FEMALE TERMINAL CPF 5/4	1.000	PC																																																																										
CE1310A1	POWER - CONTROL BOARD CONNECTING CABLE	1.000	PC																																																																										
GN1525A0	O-RING INT DIAM 9,5 THK 1 NBR 70	1.000	PC																																																																										
LP1021A0	6 SERIES L600 LED LIGHT BAR - E750	1.000	PC																																																																										
LP1027A0	L750 MM NO LED LIGHT BAR COVER	1.000	PC																																																																										
MG1083A2	MM COMPLETE HANDLE	1.000	PC																																																																										
SL1170A1	S57 BLACK SILICON - 310ml CARTRIDGE	43.000	ML																																																																										
VE1030A1	MAGNET FOR DOOR MICROSWITC H D=22,9mm	1.000	PC																																																																										
VI1034A0	STAINLESS STEEL WASHER 8,4x16x1	1.000	PC																																																																										
VI1147A0	5X25 STAINLESS STEEL SCREW	16.000	PC																																																																										
VI1220A1	4,2x12 TCB SELF-TAPPIN G SCREW	21.000	PC																																																																										
VI1996A0	M5x35 SCREW	13.000	PC																																																																										
VM1630A1	INTERNAL GLASS PUSHING CAP	1.000	PC																																																																										
VM1631A0	PLUS INNER GLASS PUSHING CAP	3.000	PC																																																																										
VM2260A1	6 SERIES DOOR UPPER LEFT CAP	1.000	PC																																																																										
VM2267A1		2.000	PC																																																																										
VM2268A0	DOOR MAGNET COVER	2.000	PC																																																																										



COMPONENT			SPARE PART																																																																										
Code	Description	Image	Code	Description	Kit components																																																																								
VT1278A	EXTERNAL GLASS SER. XEVC-1011-E		KDR1267A	1011 LEFT EXTERNAL DOOR	<table border="1"> <thead> <tr> <th>Code</th> <th>Description</th> <th>Qty</th> <th>UOM</th> </tr> </thead> <tbody> <tr> <td>VM2269A0</td> <td>INTERNAL GLASS LOCKING SYSTEM CAP</td> <td>2.000</td> <td>PC</td> </tr> <tr> <td>VM2274A0</td> <td>GROOVED BUSHING</td> <td>1.000</td> <td>PC</td> </tr> <tr> <td>VM2275A0</td> <td>SMOOTH BUSHING</td> <td>1.000</td> <td>PC</td> </tr> <tr> <td>VM2284A0</td> <td>750 SERIES DRIP PROFILE</td> <td>1.000</td> <td>PC</td> </tr> <tr> <td>VM2305A0</td> <td>MM SERIES DOOR CAP FIXING PAWL</td> <td>14.000</td> <td>PC</td> </tr> <tr> <td>VM2312A0</td> <td>MM DRIP PROFILE DRAIN LEFT PIPE</td> <td>1.000</td> <td>PC</td> </tr> <tr> <td>VM2313A0</td> <td>MM DRIP TRAY RIGHT DRAIN PIPE</td> <td>1.000</td> <td>PC</td> </tr> <tr> <td>VM2314A0</td> <td>MM DRIP PROFILE CAP</td> <td>1.000</td> <td>PC</td> </tr> <tr> <td>VM2315A0</td> <td>MIND.Maps INTERNAL GLASS CAP SUPPORT</td> <td>1.000</td> <td>PC</td> </tr> <tr> <td>VM2383A0</td> <td>MM LEFT DOOR RIGHT UPPER CAP</td> <td>1.000</td> <td>PC</td> </tr> <tr> <td>VM2385A1</td> <td>LEFT MM DOOR UPPER LEFT CAP</td> <td>1.000</td> <td>PC</td> </tr> <tr> <td>VM2386A1</td> <td>LEFT MM DOOR LOWER LEFT CAP</td> <td>1.000</td> <td>PC</td> </tr> <tr> <td>VM2410A0</td> <td>PLATE TO STOP EXTRUDED LED BAR</td> <td>2.000</td> <td>PC</td> </tr> <tr> <td>VM2505A0</td> <td>MM PLUS INTERNAL GLASS SUPPORT</td> <td>3.000</td> <td>PC</td> </tr> <tr> <td>VM2518A0</td> <td>BOARD COOLING FAN SUPPORT</td> <td>1.000</td> <td>PC</td> </tr> <tr> <td>VN1179A1</td> <td>CONTROL BOARD 40x40x20mm 12V COOLING FAN</td> <td>1.000</td> <td>PC</td> </tr> <tr> <td>VT1278A0</td> <td>EXTERNAL GLASS SER. XEVC-1011-E</td> <td>1.000</td> <td>PC</td> </tr> </tbody> </table>	Code	Description	Qty	UOM	VM2269A0	INTERNAL GLASS LOCKING SYSTEM CAP	2.000	PC	VM2274A0	GROOVED BUSHING	1.000	PC	VM2275A0	SMOOTH BUSHING	1.000	PC	VM2284A0	750 SERIES DRIP PROFILE	1.000	PC	VM2305A0	MM SERIES DOOR CAP FIXING PAWL	14.000	PC	VM2312A0	MM DRIP PROFILE DRAIN LEFT PIPE	1.000	PC	VM2313A0	MM DRIP TRAY RIGHT DRAIN PIPE	1.000	PC	VM2314A0	MM DRIP PROFILE CAP	1.000	PC	VM2315A0	MIND.Maps INTERNAL GLASS CAP SUPPORT	1.000	PC	VM2383A0	MM LEFT DOOR RIGHT UPPER CAP	1.000	PC	VM2385A1	LEFT MM DOOR UPPER LEFT CAP	1.000	PC	VM2386A1	LEFT MM DOOR LOWER LEFT CAP	1.000	PC	VM2410A0	PLATE TO STOP EXTRUDED LED BAR	2.000	PC	VM2505A0	MM PLUS INTERNAL GLASS SUPPORT	3.000	PC	VM2518A0	BOARD COOLING FAN SUPPORT	1.000	PC	VN1179A1	CONTROL BOARD 40x40x20mm 12V COOLING FAN	1.000	PC	VT1278A0	EXTERNAL GLASS SER. XEVC-1011-E	1.000	PC
					Code	Description	Qty	UOM																																																																					
					VM2269A0	INTERNAL GLASS LOCKING SYSTEM CAP	2.000	PC																																																																					
					VM2274A0	GROOVED BUSHING	1.000	PC																																																																					
					VM2275A0	SMOOTH BUSHING	1.000	PC																																																																					
					VM2284A0	750 SERIES DRIP PROFILE	1.000	PC																																																																					
					VM2305A0	MM SERIES DOOR CAP FIXING PAWL	14.000	PC																																																																					
					VM2312A0	MM DRIP PROFILE DRAIN LEFT PIPE	1.000	PC																																																																					
					VM2313A0	MM DRIP TRAY RIGHT DRAIN PIPE	1.000	PC																																																																					
					VM2314A0	MM DRIP PROFILE CAP	1.000	PC																																																																					
					VM2315A0	MIND.Maps INTERNAL GLASS CAP SUPPORT	1.000	PC																																																																					
					VM2383A0	MM LEFT DOOR RIGHT UPPER CAP	1.000	PC																																																																					
					VM2385A1	LEFT MM DOOR UPPER LEFT CAP	1.000	PC																																																																					
					VM2386A1	LEFT MM DOOR LOWER LEFT CAP	1.000	PC																																																																					
					VM2410A0	PLATE TO STOP EXTRUDED LED BAR	2.000	PC																																																																					
					VM2505A0	MM PLUS INTERNAL GLASS SUPPORT	3.000	PC																																																																					
					VM2518A0	BOARD COOLING FAN SUPPORT	1.000	PC																																																																					
					VN1179A1	CONTROL BOARD 40x40x20mm 12V COOLING FAN	1.000	PC																																																																					
					VT1278A0	EXTERNAL GLASS SER. XEVC-1011-E	1.000	PC																																																																					



COMPONENT			SPARE PART																																																																		
Code	Description	Image	Code	Description	Kit components																																																																
VT1278A	EXTERNAL GLASS SER. XEVC-1011-E		KDR1263B	1011 -M RIGHT EXTERNAL DOOR	<table border="1"> <thead> <tr> <th>Code</th> <th>Description</th> <th>Qty</th> <th>UOM</th> </tr> </thead> <tbody> <tr> <td>0B1116A0</td> <td>XEVC-1011-E LEFT EXT DOOR COLUM</td> <td>1.000</td> <td>PC</td> </tr> <tr> <td>0B1117A2</td> <td>1011 RIGHT - DOOR LEFT INT COLUMN</td> <td>1.000</td> <td>PC</td> </tr> <tr> <td>0B1118B1</td> <td>XEVC-1011 DOOR RIGHT EXTERNAL COLUMN</td> <td>1.000</td> <td>PC</td> </tr> <tr> <td>0B1119A2</td> <td>1011 RIGHT - DOOR RIGHT INT COLUMN</td> <td>1.000</td> <td>PC</td> </tr> <tr> <td>0B1122B0</td> <td>MM CT 750mm DOOR LOWER BEAM</td> <td>1.000</td> <td>PC</td> </tr> <tr> <td>0B1168A1</td> <td>XEVC-1011-E EXT GLASS SUPPORT PROFILE</td> <td>2.000</td> <td>PC</td> </tr> <tr> <td>0B1216B0</td> <td>MM DOUBLE GLASS DOOR 750mm UPPER BEAM</td> <td>1.000</td> <td>PC</td> </tr> <tr> <td>0B1217A1</td> <td>MM DOUBLE GLASS DOOR INT UPPER BEAM 750</td> <td>1.000</td> <td>PC</td> </tr> <tr> <td>CE1052A1</td> <td>MM USB-CONTRO L PANEL CONNECTING CABLE</td> <td>1.000</td> <td>PC</td> </tr> <tr> <td>CE1053B0</td> <td>MM MICROFIT LED BAR POWER SUPPLY CABL</td> <td>1.000</td> <td>PC</td> </tr> <tr> <td>CE1097A0</td> <td>4M SIHF 4 POLES MICROFIT CANBUS</td> <td>1.000</td> <td>PC</td> </tr> <tr> <td>CE1285A0</td> <td>EMI ROUND FERRITE MOD.26438015 02</td> <td>2.000</td> <td>PC</td> </tr> <tr> <td>GN1525A0</td> <td>O-RING INT DIAM 9,5 THK 1 NBR 70</td> <td>1.000</td> <td>PC</td> </tr> <tr> <td>LP1021A0</td> <td>6 SERIES L600 LED LIGHT BAR - E750</td> <td>1.000</td> <td>PC</td> </tr> <tr> <td>LP1027A0</td> <td>L750 MM NO LED LIGHT BAR COVER</td> <td>1.000</td> <td>PC</td> </tr> </tbody> </table>	Code	Description	Qty	UOM	0B1116A0	XEVC-1011-E LEFT EXT DOOR COLUM	1.000	PC	0B1117A2	1011 RIGHT - DOOR LEFT INT COLUMN	1.000	PC	0B1118B1	XEVC-1011 DOOR RIGHT EXTERNAL COLUMN	1.000	PC	0B1119A2	1011 RIGHT - DOOR RIGHT INT COLUMN	1.000	PC	0B1122B0	MM CT 750mm DOOR LOWER BEAM	1.000	PC	0B1168A1	XEVC-1011-E EXT GLASS SUPPORT PROFILE	2.000	PC	0B1216B0	MM DOUBLE GLASS DOOR 750mm UPPER BEAM	1.000	PC	0B1217A1	MM DOUBLE GLASS DOOR INT UPPER BEAM 750	1.000	PC	CE1052A1	MM USB-CONTRO L PANEL CONNECTING CABLE	1.000	PC	CE1053B0	MM MICROFIT LED BAR POWER SUPPLY CABL	1.000	PC	CE1097A0	4M SIHF 4 POLES MICROFIT CANBUS	1.000	PC	CE1285A0	EMI ROUND FERRITE MOD.26438015 02	2.000	PC	GN1525A0	O-RING INT DIAM 9,5 THK 1 NBR 70	1.000	PC	LP1021A0	6 SERIES L600 LED LIGHT BAR - E750	1.000	PC	LP1027A0	L750 MM NO LED LIGHT BAR COVER	1.000	PC
Code	Description	Qty	UOM																																																																		
0B1116A0	XEVC-1011-E LEFT EXT DOOR COLUM	1.000	PC																																																																		
0B1117A2	1011 RIGHT - DOOR LEFT INT COLUMN	1.000	PC																																																																		
0B1118B1	XEVC-1011 DOOR RIGHT EXTERNAL COLUMN	1.000	PC																																																																		
0B1119A2	1011 RIGHT - DOOR RIGHT INT COLUMN	1.000	PC																																																																		
0B1122B0	MM CT 750mm DOOR LOWER BEAM	1.000	PC																																																																		
0B1168A1	XEVC-1011-E EXT GLASS SUPPORT PROFILE	2.000	PC																																																																		
0B1216B0	MM DOUBLE GLASS DOOR 750mm UPPER BEAM	1.000	PC																																																																		
0B1217A1	MM DOUBLE GLASS DOOR INT UPPER BEAM 750	1.000	PC																																																																		
CE1052A1	MM USB-CONTRO L PANEL CONNECTING CABLE	1.000	PC																																																																		
CE1053B0	MM MICROFIT LED BAR POWER SUPPLY CABL	1.000	PC																																																																		
CE1097A0	4M SIHF 4 POLES MICROFIT CANBUS	1.000	PC																																																																		
CE1285A0	EMI ROUND FERRITE MOD.26438015 02	2.000	PC																																																																		
GN1525A0	O-RING INT DIAM 9,5 THK 1 NBR 70	1.000	PC																																																																		
LP1021A0	6 SERIES L600 LED LIGHT BAR - E750	1.000	PC																																																																		
LP1027A0	L750 MM NO LED LIGHT BAR COVER	1.000	PC																																																																		



COMPONENT			SPARE PART					
Code	Description	Image	Code	Description	Kit components			
VT1278A	EXTERNAL GLASS SER. XEVC-1011-E		KDR1263B	1011 -M RIGHT EXTERNAL DOOR	Code	Description	Qty	UOM
					MG1099A1	MM COMPLETE HANDLE	1.000	PC
					SL1170A1	S57 BLACK SILICON - 310ml CARTRIDGE	43.000	ML
					SL1221A0	GN1/1 EXTERNAL GLASS UPPER SILICONE	1.000	PC
					SL1226A0	1011 EXTERNAL GLASS LATERAL SILICONE	4.000	PC
					VE1030A1	MAGNET FOR DOOR MICROSWITC H D=22,9mm	1.000	PC
					VI1034A0	STAINLESS STEEL WASHER 8,4x16x1	1.000	PC
					VI1074A0	4X16 SCREW FOR PLASTIC	4.000	PC
					VI1174A0		16.000	PC
					VI1220A1	4,2x12 TCB SELF-TAPPIN G SCREW	30.000	PC
					VI1996A0	M5x35 SCREW	13.000	PC
					VM1490A0	CHEFTOP/BAK ERTOP HANDLE SCREWS COVER	2.000	PC
					VM1630A1	INTERNAL GLASS PUSHING CAP	5.000	PC
					VM1631A0	PLUS INNER GLASS PUSHING CAP	5.000	PC
					VM2259B0	VM2259B0	1.000	PC
					VM2268A0	DOOR MAGNET COVER	1.000	PC
					VM2274A0	GROOVED BUSHING	1.000	PC
VM2275A0	SMOOTH BUSHING	1.000	PC					
VM2284B0	750 SERIES DRIP PROFILE KIT	1.000	PC					



COMPONENT			SPARE PART																																																		
Code	Description	Image	Code	Description	Kit components																																																
VT1278A	EXTERNAL GLASS SER. XEVC-1011-E		KDR1263B	1011 -M RIGHT EXTERNAL DOOR	<table border="1"> <thead> <tr> <th>Code</th> <th>Description</th> <th>Qty</th> <th>UOM</th> </tr> </thead> <tbody> <tr> <td>VM2305A0</td> <td>MM SERIES DOOR CAP FIXING PAWL</td> <td>14.000</td> <td>PC</td> </tr> <tr> <td>VM2312A0</td> <td>MM DRIP PROFILE DRAIN LEFT PIPE</td> <td>1.000</td> <td>PC</td> </tr> <tr> <td>VM2314A0</td> <td>MM DRIP PROFILE CAP</td> <td>1.000</td> <td>PC</td> </tr> <tr> <td>VM2315B0</td> <td>MM - M INNER GLASS PUSHING CAP HOLDER</td> <td>5.000</td> <td>PC</td> </tr> <tr> <td>VM2410A0</td> <td>PLATE TO STOP EXTRUDED LED BAR</td> <td>2.000</td> <td>PC</td> </tr> <tr> <td>VM2505B1</td> <td>MM PLUS INTERNAL GLASS SUPPORT</td> <td>5.000</td> <td>PC</td> </tr> <tr> <td>VM3008A0</td> <td></td> <td>1.000</td> <td>PC</td> </tr> <tr> <td>VM3010A0</td> <td></td> <td>1.000</td> <td>PC</td> </tr> <tr> <td>VM3011A0</td> <td></td> <td>1.000</td> <td>PC</td> </tr> <tr> <td>VP1080A0</td> <td>UPPER HINGE CAP FOR LOWER INNER GLASS</td> <td>1.000</td> <td>PC</td> </tr> <tr> <td>VT1278A0</td> <td>EXTERNAL GLASS SER. XEVC-1011-E</td> <td>1.000</td> <td>PC</td> </tr> </tbody> </table>	Code	Description	Qty	UOM	VM2305A0	MM SERIES DOOR CAP FIXING PAWL	14.000	PC	VM2312A0	MM DRIP PROFILE DRAIN LEFT PIPE	1.000	PC	VM2314A0	MM DRIP PROFILE CAP	1.000	PC	VM2315B0	MM - M INNER GLASS PUSHING CAP HOLDER	5.000	PC	VM2410A0	PLATE TO STOP EXTRUDED LED BAR	2.000	PC	VM2505B1	MM PLUS INTERNAL GLASS SUPPORT	5.000	PC	VM3008A0		1.000	PC	VM3010A0		1.000	PC	VM3011A0		1.000	PC	VP1080A0	UPPER HINGE CAP FOR LOWER INNER GLASS	1.000	PC	VT1278A0	EXTERNAL GLASS SER. XEVC-1011-E	1.000	PC
			Code	Description	Qty	UOM																																															
VM2305A0	MM SERIES DOOR CAP FIXING PAWL	14.000	PC																																																		
VM2312A0	MM DRIP PROFILE DRAIN LEFT PIPE	1.000	PC																																																		
VM2314A0	MM DRIP PROFILE CAP	1.000	PC																																																		
VM2315B0	MM - M INNER GLASS PUSHING CAP HOLDER	5.000	PC																																																		
VM2410A0	PLATE TO STOP EXTRUDED LED BAR	2.000	PC																																																		
VM2505B1	MM PLUS INTERNAL GLASS SUPPORT	5.000	PC																																																		
VM3008A0		1.000	PC																																																		
VM3010A0		1.000	PC																																																		
VM3011A0		1.000	PC																																																		
VP1080A0	UPPER HINGE CAP FOR LOWER INNER GLASS	1.000	PC																																																		
VT1278A0	EXTERNAL GLASS SER. XEVC-1011-E	1.000	PC																																																		
KDR1263A	1011 RIGHT EXTERNAL DOOR KI	<table border="1"> <thead> <tr> <th>Code</th> <th>Description</th> <th>Qty</th> <th>UOM</th> </tr> </thead> <tbody> <tr> <td>0B1116A0</td> <td>XEVC-1011-E LEFT EXT DOOR COLUMN</td> <td>1.000</td> <td>PC</td> </tr> <tr> <td>0B1117A2</td> <td>1011 RIGHT - DOOR LEFT INT COLUMN</td> <td>1.000</td> <td>PC</td> </tr> <tr> <td>0B1118B1</td> <td>XEVC-1011 DOOR RIGHT EXTERNAL COLUMN</td> <td>1.000</td> <td>PC</td> </tr> <tr> <td>0B1119A2</td> <td>1011 RIGHT - DOOR RIGHT INT COLUMN</td> <td>1.000</td> <td>PC</td> </tr> <tr> <td>0B1122A1</td> <td>750MM DOOR LOWER FRAME SHAPE</td> <td>1.000</td> <td>PC</td> </tr> <tr> <td>0B1168A1</td> <td>XEVC-1011-E EXT GLASS SUPPORT PROFILE</td> <td>2.000</td> <td>PC</td> </tr> </tbody> </table>	Code	Description	Qty	UOM	0B1116A0	XEVC-1011-E LEFT EXT DOOR COLUMN	1.000	PC	0B1117A2	1011 RIGHT - DOOR LEFT INT COLUMN	1.000	PC	0B1118B1	XEVC-1011 DOOR RIGHT EXTERNAL COLUMN	1.000	PC	0B1119A2	1011 RIGHT - DOOR RIGHT INT COLUMN	1.000	PC	0B1122A1	750MM DOOR LOWER FRAME SHAPE	1.000	PC	0B1168A1	XEVC-1011-E EXT GLASS SUPPORT PROFILE	2.000	PC																							
Code	Description	Qty	UOM																																																		
0B1116A0	XEVC-1011-E LEFT EXT DOOR COLUMN	1.000	PC																																																		
0B1117A2	1011 RIGHT - DOOR LEFT INT COLUMN	1.000	PC																																																		
0B1118B1	XEVC-1011 DOOR RIGHT EXTERNAL COLUMN	1.000	PC																																																		
0B1119A2	1011 RIGHT - DOOR RIGHT INT COLUMN	1.000	PC																																																		
0B1122A1	750MM DOOR LOWER FRAME SHAPE	1.000	PC																																																		
0B1168A1	XEVC-1011-E EXT GLASS SUPPORT PROFILE	2.000	PC																																																		



COMPONENT			SPARE PART					
Code	Description	Image	Code	Description	Kit components			
VT1278A	EXTERNAL GLASS SER. XEVC-1011-E		KDR1263A	1011 RIGHT EXTERNAL DOOR KI	Code	Description	Qty	UOM
					0B1216A1	MM CT DOUBLE GLASS DOOR UPPER BEAM	1.000	PC
					0B1217A1	MM DOUBLE GLASS DOOR INT UPPER BEAM 750	1.000	PC
					CE1052A1	MM USB-CONTRO L PANEL CONNECTING CABLE	1.000	PC
					CE1053B0	MM MICROFIT LED BAR POWER SUPPLY CABL	1.000	PC
					CE1285A0	EMI ROUND FERRITE MOD.26438015 02	1.000	PC
					CE1290A0	EXTRACTABL E FEMALE TERMINAL CPF 5/4	1.000	PC
					CE1310A1	POWER - CONTROL BOARD CONNECTING CABLE	1.000	PC
					GN1525A0	O-RING INT DIAM 9,5 THK 1 NBR 70	1.000	PC
					LP1021A0	6 SERIES L600 LED LIGHT BAR - E750	1.000	PC
					LP1027A0	L750 MM NO LED LIGHT BAR COVER	1.000	PC
					MG1083A2	MM COMPLETE HANDLE	1.000	PC
					SL1170A1	S57 BLACK SILICON - 310ml CARTRIDGE	43.000	ML
					VE1030A1	MAGNET FOR DOOR MICROSWITC H D=22,9mm	1.000	PC
					VI1034A0	STAINLESS STEEL WASHER 8.4x16x1	1.000	PC



COMPONENT			SPARE PART																																																																																							
Code	Description	Image	Code	Description	Kit components																																																																																					
VT1278A	EXTERNAL GLASS SER. XEVC-1011-E		KDR1263A	1011 RIGHT EXTERNAL DOOR KI	<table border="1"> <thead> <tr> <th>Code</th> <th>Description</th> <th>Qty</th> <th>UOM</th> </tr> </thead> <tbody> <tr> <td>VI1147A0</td> <td>5X25 STAINLESS STEEL SCREW</td> <td>16.000</td> <td>PC</td> </tr> <tr> <td>VI1220A1</td> <td>4,2x12 TCB SELF-TAPPIN G SCREW</td> <td>23.000</td> <td>PC</td> </tr> <tr> <td>VI1996A0</td> <td>M5x35 SCREW</td> <td>13.000</td> <td>PC</td> </tr> <tr> <td>VM1630A1</td> <td>INTERNAL GLASS PUSHING CAP</td> <td>1.000</td> <td>PC</td> </tr> <tr> <td>VM1631A0</td> <td>PLUS INNER GLASS PUSHING CAP</td> <td>3.000</td> <td>PC</td> </tr> <tr> <td>VM2259A1</td> <td>6 SERIES DOOR LOWER LEFT CAP</td> <td>1.000</td> <td>PC</td> </tr> <tr> <td>VM2260A1</td> <td>6 SERIES DOOR UPPER LEFT CAP</td> <td>1.000</td> <td>PC</td> </tr> <tr> <td>VM2261A1</td> <td>MM DOOR LOWER RIGHT CAP</td> <td>1.000</td> <td>PC</td> </tr> <tr> <td>VM2262A1</td> <td>MM DOOR UPPER RIGHT CAP</td> <td>1.000</td> <td>PC</td> </tr> <tr> <td>VM2267A1</td> <td></td> <td>2.000</td> <td>PC</td> </tr> <tr> <td>VM2268A0</td> <td>DOOR MAGNET COVER</td> <td>2.000</td> <td>PC</td> </tr> <tr> <td>VM2269A0</td> <td>INTERNAL GLASS LOCKING SYSTEM CAP</td> <td>2.000</td> <td>PC</td> </tr> <tr> <td>VM2274A0</td> <td>GROOVED BUSHING</td> <td>1.000</td> <td>PC</td> </tr> <tr> <td>VM2275A0</td> <td>SMOOTH BUSHING</td> <td>1.000</td> <td>PC</td> </tr> <tr> <td>VM2284A0</td> <td>750 SERIES DRIP PROFILE</td> <td>1.000</td> <td>PC</td> </tr> <tr> <td>VM2305A0</td> <td>MM SERIES DOOR CAP FIXING PAWL</td> <td>14.000</td> <td>PC</td> </tr> <tr> <td>VM2312A0</td> <td>MM DRIP PROFILE DRAIN LEFT PIPE</td> <td>1.000</td> <td>PC</td> </tr> <tr> <td>VM2313A0</td> <td>MM DRIP TRAY RIGHT DRAIN PIPE</td> <td>1.000</td> <td>PC</td> </tr> <tr> <td>VM2314A0</td> <td>MM DRIP PROFILE CAP</td> <td>1.000</td> <td>PC</td> </tr> <tr> <td>VM2315A0</td> <td>MIND.Maps INTERNAL GLASS CAP SUPPORT</td> <td>1.000</td> <td>PC</td> </tr> </tbody> </table>	Code	Description	Qty	UOM	VI1147A0	5X25 STAINLESS STEEL SCREW	16.000	PC	VI1220A1	4,2x12 TCB SELF-TAPPIN G SCREW	23.000	PC	VI1996A0	M5x35 SCREW	13.000	PC	VM1630A1	INTERNAL GLASS PUSHING CAP	1.000	PC	VM1631A0	PLUS INNER GLASS PUSHING CAP	3.000	PC	VM2259A1	6 SERIES DOOR LOWER LEFT CAP	1.000	PC	VM2260A1	6 SERIES DOOR UPPER LEFT CAP	1.000	PC	VM2261A1	MM DOOR LOWER RIGHT CAP	1.000	PC	VM2262A1	MM DOOR UPPER RIGHT CAP	1.000	PC	VM2267A1		2.000	PC	VM2268A0	DOOR MAGNET COVER	2.000	PC	VM2269A0	INTERNAL GLASS LOCKING SYSTEM CAP	2.000	PC	VM2274A0	GROOVED BUSHING	1.000	PC	VM2275A0	SMOOTH BUSHING	1.000	PC	VM2284A0	750 SERIES DRIP PROFILE	1.000	PC	VM2305A0	MM SERIES DOOR CAP FIXING PAWL	14.000	PC	VM2312A0	MM DRIP PROFILE DRAIN LEFT PIPE	1.000	PC	VM2313A0	MM DRIP TRAY RIGHT DRAIN PIPE	1.000	PC	VM2314A0	MM DRIP PROFILE CAP	1.000	PC	VM2315A0	MIND.Maps INTERNAL GLASS CAP SUPPORT	1.000	PC	
Code	Description	Qty	UOM																																																																																							
VI1147A0	5X25 STAINLESS STEEL SCREW	16.000	PC																																																																																							
VI1220A1	4,2x12 TCB SELF-TAPPIN G SCREW	23.000	PC																																																																																							
VI1996A0	M5x35 SCREW	13.000	PC																																																																																							
VM1630A1	INTERNAL GLASS PUSHING CAP	1.000	PC																																																																																							
VM1631A0	PLUS INNER GLASS PUSHING CAP	3.000	PC																																																																																							
VM2259A1	6 SERIES DOOR LOWER LEFT CAP	1.000	PC																																																																																							
VM2260A1	6 SERIES DOOR UPPER LEFT CAP	1.000	PC																																																																																							
VM2261A1	MM DOOR LOWER RIGHT CAP	1.000	PC																																																																																							
VM2262A1	MM DOOR UPPER RIGHT CAP	1.000	PC																																																																																							
VM2267A1		2.000	PC																																																																																							
VM2268A0	DOOR MAGNET COVER	2.000	PC																																																																																							
VM2269A0	INTERNAL GLASS LOCKING SYSTEM CAP	2.000	PC																																																																																							
VM2274A0	GROOVED BUSHING	1.000	PC																																																																																							
VM2275A0	SMOOTH BUSHING	1.000	PC																																																																																							
VM2284A0	750 SERIES DRIP PROFILE	1.000	PC																																																																																							
VM2305A0	MM SERIES DOOR CAP FIXING PAWL	14.000	PC																																																																																							
VM2312A0	MM DRIP PROFILE DRAIN LEFT PIPE	1.000	PC																																																																																							
VM2313A0	MM DRIP TRAY RIGHT DRAIN PIPE	1.000	PC																																																																																							
VM2314A0	MM DRIP PROFILE CAP	1.000	PC																																																																																							
VM2315A0	MIND.Maps INTERNAL GLASS CAP SUPPORT	1.000	PC																																																																																							



COMPONENT			SPARE PART																										
Code	Description	Image	Code	Description	Kit components																								
VT1278A	EXTERNAL GLASS SER. XEVC-1011-E		KDR1263A	1011 RIGHT EXTERNAL DOOR KI	<table border="1"> <thead> <tr> <th>Code</th> <th>Description</th> <th>Qty</th> <th>UOM</th> </tr> </thead> <tbody> <tr> <td>VM2410A0</td> <td>PLATE TO STOP EXTRUDED LED BAR</td> <td>2.000</td> <td>PC</td> </tr> <tr> <td>VM2505A0</td> <td>MM PLUS INTERNAL GLASS SUPPORT</td> <td>3.000</td> <td>PC</td> </tr> <tr> <td>VM2518A0</td> <td>BOARD COOLING FAN SUPPORT</td> <td>1.000</td> <td>PC</td> </tr> <tr> <td>VN1179A1</td> <td>CONTROL BOARD 40x40x20mm 12V COOLING FAN</td> <td>1.000</td> <td>PC</td> </tr> <tr> <td>VT1278A0</td> <td>EXTERNAL GLASS SER. XEVC-1011-E</td> <td>1.000</td> <td>PC</td> </tr> </tbody> </table>	Code	Description	Qty	UOM	VM2410A0	PLATE TO STOP EXTRUDED LED BAR	2.000	PC	VM2505A0	MM PLUS INTERNAL GLASS SUPPORT	3.000	PC	VM2518A0	BOARD COOLING FAN SUPPORT	1.000	PC	VN1179A1	CONTROL BOARD 40x40x20mm 12V COOLING FAN	1.000	PC	VT1278A0	EXTERNAL GLASS SER. XEVC-1011-E	1.000	PC
Code	Description	Qty	UOM																										
VM2410A0	PLATE TO STOP EXTRUDED LED BAR	2.000	PC																										
VM2505A0	MM PLUS INTERNAL GLASS SUPPORT	3.000	PC																										
VM2518A0	BOARD COOLING FAN SUPPORT	1.000	PC																										
VN1179A1	CONTROL BOARD 40x40x20mm 12V COOLING FAN	1.000	PC																										
VT1278A0	EXTERNAL GLASS SER. XEVC-1011-E	1.000	PC																										

ASM4042D/0.D12 - Cooking chamber - FRONT

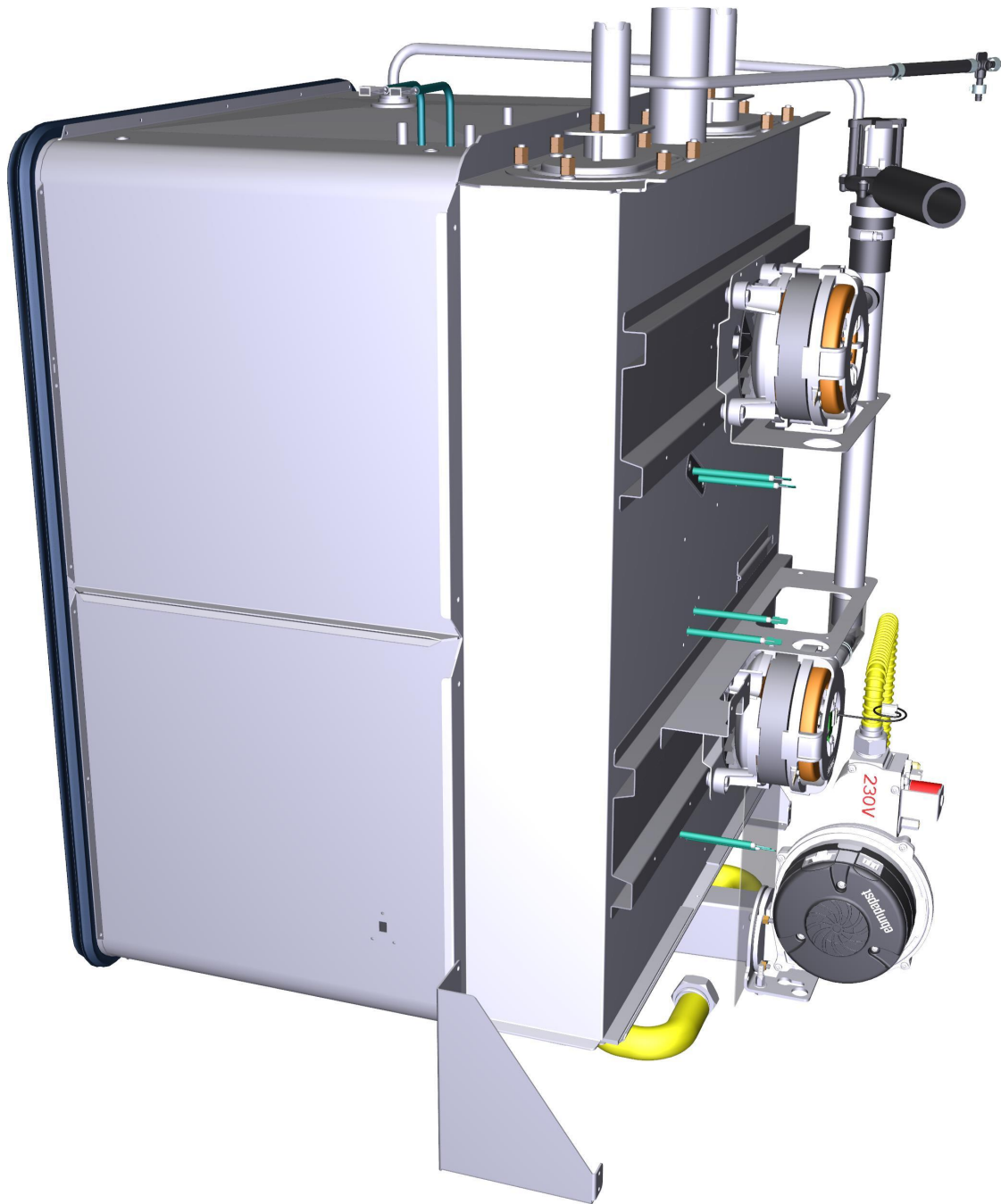











ASM4042D/0.D12 - Cooking chamber - REAR





COMPONENT			SPARE PART																										
Code	Description	Image	Code	Description	Kit components																								
0G1596A	XEBC-06EU-G FAN GUARD		K0G1596A	KIT DISTANCE CARTER AIR XEBC-06EU-G	<table border="1"> <thead> <tr> <th>Code</th> <th>Description</th> <th>Qty</th> <th>UOM</th> </tr> </thead> <tbody> <tr> <td>0G1314A0</td> <td>AIR CARTER SPACER 0711-G 316L</td> <td>1.000</td> <td>PC</td> </tr> <tr> <td>V11220A1</td> <td>4,2x12 TCB SELF-TAPPING SCREW</td> <td>6.000</td> <td>PC</td> </tr> <tr> <td>V11340A0</td> <td>M6 ST. STEEL THREADED INSERT</td> <td>2.000</td> <td>PC</td> </tr> <tr> <td>V11836A0</td> <td>M6x12 OT63 HEX HEAD SMOOTH FLANGE SCREW</td> <td>1.000</td> <td>PC</td> </tr> <tr> <td>VM1820A0</td> <td>LATERAL SUPPORTS M6 FIXING BOLT</td> <td>1.000</td> <td>PC</td> </tr> </tbody> </table>	Code	Description	Qty	UOM	0G1314A0	AIR CARTER SPACER 0711-G 316L	1.000	PC	V11220A1	4,2x12 TCB SELF-TAPPING SCREW	6.000	PC	V11340A0	M6 ST. STEEL THREADED INSERT	2.000	PC	V11836A0	M6x12 OT63 HEX HEAD SMOOTH FLANGE SCREW	1.000	PC	VM1820A0	LATERAL SUPPORTS M6 FIXING BOLT	1.000	PC
Code	Description	Qty	UOM																										
0G1314A0	AIR CARTER SPACER 0711-G 316L	1.000	PC																										
V11220A1	4,2x12 TCB SELF-TAPPING SCREW	6.000	PC																										
V11340A0	M6 ST. STEEL THREADED INSERT	2.000	PC																										
V11836A0	M6x12 OT63 HEX HEAD SMOOTH FLANGE SCREW	1.000	PC																										
VM1820A0	LATERAL SUPPORTS M6 FIXING BOLT	1.000	PC																										
0H2551A	ST STEEL DRAIN GRID		K0H2551A	DRAIN COVER KIT	<table border="1"> <thead> <tr> <th>Code</th> <th>Description</th> <th>Qty</th> <th>UOM</th> </tr> </thead> <tbody> <tr> <td>0H2617A0</td> <td>AISI316 DRAIN GRID</td> <td>1.000</td> <td>PC</td> </tr> </tbody> </table>	Code	Description	Qty	UOM	0H2617A0	AISI316 DRAIN GRID	1.000	PC																
Code	Description	Qty	UOM																										
0H2617A0	AISI316 DRAIN GRID	1.000	PC																										
0H7230A	XEVC GAS CHAMBER LEFT HOLDING BRACKET		0H7230A0	XEVC GAS CHAMBER LEFT HOLDING BRACKET																									
0H7231A	XEVC GAS CHAMBER RIGHT HOLDING BRACKET		0H7231A0	XEVC GAS CHAMBER RIGHT HOLDING BRACKET																									

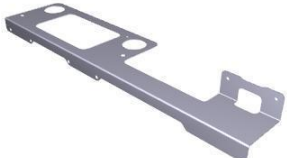



COMPONENT			SPARE PART																		
Code	Description	Image	Code	Description	Kit components																
0H7449A	MM GAS VENTURI COLLECT PIPE FIXING PLATE		0H7449A0	MM GAS VENTURI COLLECT PIPE FIXING PLATE																	
0H7629A	0H7629A1		0H7629A1	0H7629A1																	
0H7741B	HEAT EXCH TIE ROD ANTI ROTATION PLATE		0H7741B0	HEAT EXCH TIE ROD ANTI ROTATION PLATE																	
0H8187A	GN11 EL COMPONENTS PLATE/VENTURI HOLDER		0H8187A0	GN11 EL COMPONENTS PLATE/VENTURI HOLDER																	
PE1710B	MOTOR REVOLUTION AND DIRECTION SENSO		KPE1710B	MOTOR REVOLUTIONS SENSOR KIT	<table border="1"> <thead> <tr> <th>Code</th> <th>Description</th> <th>Qty</th> <th>UOM</th> </tr> </thead> <tbody> <tr> <td>CE1119A0</td> <td>AMPMODU2 4P 4XAWG22 L1500 RAST 4P CABLE</td> <td>1.000</td> <td>PC</td> </tr> <tr> <td>PE1040A0</td> <td>RAST MOTOR SENSOR</td> <td>1.000</td> <td>PC</td> </tr> <tr> <td>VI1966A1</td> <td>M4x14 FLATHEAD SCREW</td> <td>1.000</td> <td>PC</td> </tr> </tbody> </table>	Code	Description	Qty	UOM	CE1119A0	AMPMODU2 4P 4XAWG22 L1500 RAST 4P CABLE	1.000	PC	PE1040A0	RAST MOTOR SENSOR	1.000	PC	VI1966A1	M4x14 FLATHEAD SCREW	1.000	PC
Code	Description	Qty	UOM																		
CE1119A0	AMPMODU2 4P 4XAWG22 L1500 RAST 4P CABLE	1.000	PC																		
PE1040A0	RAST MOTOR SENSOR	1.000	PC																		
VI1966A1	M4x14 FLATHEAD SCREW	1.000	PC																		





COMPONENT			SPARE PART																														
Code	Description	Image	Code	Description	Kit components																												
GN1285A	NTC TEMPERATURE PROBE SEALING		KTR1106B	MIND.Maps L2000 CHAMBER TEMP. PROBE KIT	<table border="1"> <thead> <tr> <th>Code</th> <th>Description</th> <th>Qty</th> <th>UOM</th> </tr> </thead> <tbody> <tr> <td>GN1285A0</td> <td>NTC TEMPERATUR E PROBE SEALING</td> <td>1.000</td> <td>PC</td> </tr> <tr> <td>SL1045A0</td> <td>S57 BLACK SILICONE - 80ml CARTRIDGE</td> <td>1.000</td> <td>PC</td> </tr> <tr> <td>TR1106B0</td> <td>PT100 L=2000 TEMPERATUR E PROBE</td> <td>1.000</td> <td>PC</td> </tr> <tr> <td>VI1220A1</td> <td>4,2x12 TCB SELF-TAPPIN G SCREW</td> <td>2.000</td> <td>PC</td> </tr> <tr> <td>VM1464A1</td> <td>CT BT TEMPERATUR E PROBE COVER</td> <td>1.000</td> <td>PC</td> </tr> <tr> <td>VM1465A1</td> <td>CT BT TEMPERATUR E PROBE COVER</td> <td>1.000</td> <td>PC</td> </tr> </tbody> </table>	Code	Description	Qty	UOM	GN1285A0	NTC TEMPERATUR E PROBE SEALING	1.000	PC	SL1045A0	S57 BLACK SILICONE - 80ml CARTRIDGE	1.000	PC	TR1106B0	PT100 L=2000 TEMPERATUR E PROBE	1.000	PC	VI1220A1	4,2x12 TCB SELF-TAPPIN G SCREW	2.000	PC	VM1464A1	CT BT TEMPERATUR E PROBE COVER	1.000	PC	VM1465A1	CT BT TEMPERATUR E PROBE COVER	1.000	PC
			Code	Description	Qty	UOM																											
			GN1285A0	NTC TEMPERATUR E PROBE SEALING	1.000	PC																											
SL1045A0	S57 BLACK SILICONE - 80ml CARTRIDGE	1.000	PC																														
TR1106B0	PT100 L=2000 TEMPERATUR E PROBE	1.000	PC																														
VI1220A1	4,2x12 TCB SELF-TAPPIN G SCREW	2.000	PC																														
VM1464A1	CT BT TEMPERATUR E PROBE COVER	1.000	PC																														
VM1465A1	CT BT TEMPERATUR E PROBE COVER	1.000	PC																														
KTR1106A	5-5E S. L2000 CHAMBER TEMP. PROBE KIT	<table border="1"> <thead> <tr> <th>Code</th> <th>Description</th> <th>Qty</th> <th>UOM</th> </tr> </thead> <tbody> <tr> <td>GN1285A0</td> <td>NTC TEMPERATUR E PROBE SEALING</td> <td>1.000</td> <td>PC</td> </tr> <tr> <td>SL1045A0</td> <td>S57 BLACK SILICONE - 80ml CARTRIDGE</td> <td>1.000</td> <td>PC</td> </tr> <tr> <td>TR1106A3</td> <td>PT100 L=2000 TEMPERATUR E PROBE</td> <td>1.000</td> <td>PC</td> </tr> <tr> <td>VI1220A1</td> <td>4,2x12 TCB SELF-TAPPIN G SCREW</td> <td>2.000</td> <td>PC</td> </tr> <tr> <td>VM1465A1</td> <td>CT BT TEMPERATUR E PROBE COVER</td> <td>1.000</td> <td>PC</td> </tr> </tbody> </table>	Code	Description	Qty	UOM	GN1285A0	NTC TEMPERATUR E PROBE SEALING	1.000	PC	SL1045A0	S57 BLACK SILICONE - 80ml CARTRIDGE	1.000	PC	TR1106A3	PT100 L=2000 TEMPERATUR E PROBE	1.000	PC	VI1220A1	4,2x12 TCB SELF-TAPPIN G SCREW	2.000	PC	VM1465A1	CT BT TEMPERATUR E PROBE COVER	1.000	PC							
Code	Description	Qty	UOM																														
GN1285A0	NTC TEMPERATUR E PROBE SEALING	1.000	PC																														
SL1045A0	S57 BLACK SILICONE - 80ml CARTRIDGE	1.000	PC																														
TR1106A3	PT100 L=2000 TEMPERATUR E PROBE	1.000	PC																														
VI1220A1	4,2x12 TCB SELF-TAPPIN G SCREW	2.000	PC																														
VM1465A1	CT BT TEMPERATUR E PROBE COVER	1.000	PC																														
KTR1105A	PT100 L1000 TEMPERATURE PROBE KIT	<table border="1"> <thead> <tr> <th>Code</th> <th>Description</th> <th>Qty</th> <th>UOM</th> </tr> </thead> <tbody> <tr> <td>0H4302A0</td> <td>PROBES SILICON HOLDER</td> <td>1.000</td> <td>PC</td> </tr> <tr> <td>GN1120A1</td> <td>NTC TEMPERATUR E PROBE SEAL</td> <td>1.000</td> <td>PC</td> </tr> <tr> <td>GN1285A0</td> <td>NTC TEMPERATUR E PROBE SEALING</td> <td>1.000</td> <td>PC</td> </tr> </tbody> </table>	Code	Description	Qty	UOM	0H4302A0	PROBES SILICON HOLDER	1.000	PC	GN1120A1	NTC TEMPERATUR E PROBE SEAL	1.000	PC	GN1285A0	NTC TEMPERATUR E PROBE SEALING	1.000	PC															
Code	Description	Qty	UOM																														
0H4302A0	PROBES SILICON HOLDER	1.000	PC																														
GN1120A1	NTC TEMPERATUR E PROBE SEAL	1.000	PC																														
GN1285A0	NTC TEMPERATUR E PROBE SEALING	1.000	PC																														



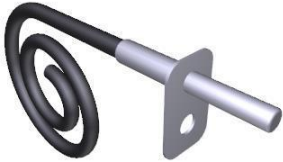

COMPONENT			SPARE PART																														
Code	Description	Image	Code	Description	Kit components																												
GN1285A	NTC TEMPERATURE PROBE SEALING		KTR1105A	PT100 L1000 TEMPERATURE PROBE KIT	<table border="1"> <thead> <tr> <th>Code</th> <th>Description</th> <th>Qty</th> <th>UOM</th> </tr> </thead> <tbody> <tr> <td>SL1045A0</td> <td>S57 BLACK SILICONE - 80ml CARTRIDGE</td> <td>1.000</td> <td>PC</td> </tr> <tr> <td>TR1105A4</td> <td>L1000 PT100 TEMPERATUR E PROBE</td> <td>1.000</td> <td>PC</td> </tr> <tr> <td>VI1220A1</td> <td>4,2x12 TCB SELF-TAPPIN G SCREW</td> <td>2.000</td> <td>PC</td> </tr> <tr> <td>VM1464A1</td> <td>CT BT TEMPERATUR E PROBE COVER</td> <td>1.000</td> <td>PC</td> </tr> <tr> <td>VM1465A1</td> <td>CT BT TEMPERATUR E PROBE COVER</td> <td>1.000</td> <td>PC</td> </tr> <tr> <td>VM2052A0</td> <td>LM CORE PROBE COVE</td> <td>1.000</td> <td>PC</td> </tr> </tbody> </table>	Code	Description	Qty	UOM	SL1045A0	S57 BLACK SILICONE - 80ml CARTRIDGE	1.000	PC	TR1105A4	L1000 PT100 TEMPERATUR E PROBE	1.000	PC	VI1220A1	4,2x12 TCB SELF-TAPPIN G SCREW	2.000	PC	VM1464A1	CT BT TEMPERATUR E PROBE COVER	1.000	PC	VM1465A1	CT BT TEMPERATUR E PROBE COVER	1.000	PC	VM2052A0	LM CORE PROBE COVE	1.000	PC
			Code	Description	Qty	UOM																											
			SL1045A0	S57 BLACK SILICONE - 80ml CARTRIDGE	1.000	PC																											
TR1105A4	L1000 PT100 TEMPERATUR E PROBE	1.000	PC																														
VI1220A1	4,2x12 TCB SELF-TAPPIN G SCREW	2.000	PC																														
VM1464A1	CT BT TEMPERATUR E PROBE COVER	1.000	PC																														
VM1465A1	CT BT TEMPERATUR E PROBE COVER	1.000	PC																														
VM2052A0	LM CORE PROBE COVE	1.000	PC																														
KTR1096A	NTC 150 L=1500 TEMPERATURE PROBE KIT	<table border="1"> <thead> <tr> <th>Code</th> <th>Description</th> <th>Qty</th> <th>UOM</th> </tr> </thead> <tbody> <tr> <td>GN1120A1</td> <td>NTC TEMPERATUR E PROBE SEAL</td> <td>1.000</td> <td>PC</td> </tr> <tr> <td>GN1285A0</td> <td>NTC TEMPERATUR E PROBE SEALING</td> <td>2.000</td> <td>PC</td> </tr> <tr> <td>SL1045A0</td> <td>S57 BLACK SILICONE - 80ml CARTRIDGE</td> <td>1.000</td> <td>PC</td> </tr> <tr> <td>TR1096A0</td> <td>TEMPERATUR E PROBE NTC 150 L=1500</td> <td>1.000</td> <td>PC</td> </tr> <tr> <td>VI1220A1</td> <td>4,2x12 TCB SELF-TAPPIN G SCREW</td> <td>2.000</td> <td>PC</td> </tr> <tr> <td>VM1465A1</td> <td>CT BT TEMPERATUR E PROBE COVER</td> <td>1.000</td> <td>PC</td> </tr> </tbody> </table>	Code	Description	Qty	UOM	GN1120A1	NTC TEMPERATUR E PROBE SEAL	1.000	PC	GN1285A0	NTC TEMPERATUR E PROBE SEALING	2.000	PC	SL1045A0	S57 BLACK SILICONE - 80ml CARTRIDGE	1.000	PC	TR1096A0	TEMPERATUR E PROBE NTC 150 L=1500	1.000	PC	VI1220A1	4,2x12 TCB SELF-TAPPIN G SCREW	2.000	PC	VM1465A1	CT BT TEMPERATUR E PROBE COVER	1.000	PC			
Code	Description	Qty	UOM																														
GN1120A1	NTC TEMPERATUR E PROBE SEAL	1.000	PC																														
GN1285A0	NTC TEMPERATUR E PROBE SEALING	2.000	PC																														
SL1045A0	S57 BLACK SILICONE - 80ml CARTRIDGE	1.000	PC																														
TR1096A0	TEMPERATUR E PROBE NTC 150 L=1500	1.000	PC																														
VI1220A1	4,2x12 TCB SELF-TAPPIN G SCREW	2.000	PC																														
VM1465A1	CT BT TEMPERATUR E PROBE COVER	1.000	PC																														
KTR1095A	NTC 150 L=1050 TEMPERATURE PROBE KIT	<table border="1"> <thead> <tr> <th>Code</th> <th>Description</th> <th>Qty</th> <th>UOM</th> </tr> </thead> <tbody> <tr> <td>GN1120A1</td> <td>NTC TEMPERATUR E PROBE SEAL</td> <td>1.000</td> <td>PC</td> </tr> <tr> <td>GN1285A0</td> <td>NTC TEMPERATUR E PROBE SEALING</td> <td>1.000</td> <td>PC</td> </tr> </tbody> </table>	Code	Description	Qty	UOM	GN1120A1	NTC TEMPERATUR E PROBE SEAL	1.000	PC	GN1285A0	NTC TEMPERATUR E PROBE SEALING	1.000	PC																			
Code	Description	Qty	UOM																														
GN1120A1	NTC TEMPERATUR E PROBE SEAL	1.000	PC																														
GN1285A0	NTC TEMPERATUR E PROBE SEALING	1.000	PC																														

COMPONENT			SPARE PART																														
Code	Description	Image	Code	Description	Kit components																												
GN1285A	NTC TEMPERATURE PROBE SEALING		KTR1095A	NTC 150 L=1050 TEMPERATURE PROBE KIT	<table border="1"> <thead> <tr> <th>Code</th> <th>Description</th> <th>Qty</th> <th>UOM</th> </tr> </thead> <tbody> <tr> <td>SL1045A0</td> <td>S57 BLACK SILICONE - 80ml CARTRIDGE</td> <td>1.000</td> <td>PC</td> </tr> <tr> <td>TR1095A0</td> <td>TEMPERATUR E PROBE NTC 150 L=1050</td> <td>1.000</td> <td>PC</td> </tr> <tr> <td>VI1220A1</td> <td>4,2x12 TCB SELF-TAPPIN G SCREW</td> <td>2.000</td> <td>PC</td> </tr> <tr> <td>VM1465A1</td> <td>CT BT TEMPERATUR E PROBE COVER</td> <td>1.000</td> <td>PC</td> </tr> </tbody> </table>	Code	Description	Qty	UOM	SL1045A0	S57 BLACK SILICONE - 80ml CARTRIDGE	1.000	PC	TR1095A0	TEMPERATUR E PROBE NTC 150 L=1050	1.000	PC	VI1220A1	4,2x12 TCB SELF-TAPPIN G SCREW	2.000	PC	VM1465A1	CT BT TEMPERATUR E PROBE COVER	1.000	PC								
			Code	Description	Qty	UOM																											
SL1045A0	S57 BLACK SILICONE - 80ml CARTRIDGE	1.000	PC																														
TR1095A0	TEMPERATUR E PROBE NTC 150 L=1050	1.000	PC																														
VI1220A1	4,2x12 TCB SELF-TAPPIN G SCREW	2.000	PC																														
VM1465A1	CT BT TEMPERATUR E PROBE COVER	1.000	PC																														
KTR1002A	PT100 L1000 UL TEMPERATURE PROBE KIT	<table border="1"> <thead> <tr> <th>Code</th> <th>Description</th> <th>Qty</th> <th>UOM</th> </tr> </thead> <tbody> <tr> <td>GN1285A0</td> <td>NTC TEMPERATUR E PROBE SEALING</td> <td>2.000</td> <td>PC</td> </tr> <tr> <td>SL1045A0</td> <td>S57 BLACK SILICONE - 80ml CARTRIDGE</td> <td>1.000</td> <td>PC</td> </tr> <tr> <td>TR1002A1</td> <td></td> <td>1.000</td> <td>PC</td> </tr> <tr> <td>VI1220A1</td> <td>4,2x12 TCB SELF-TAPPIN G SCREW</td> <td>2.000</td> <td>PC</td> </tr> <tr> <td>VM1465A1</td> <td>CT BT TEMPERATUR E PROBE COVER</td> <td>1.000</td> <td>PC</td> </tr> </tbody> </table>	Code	Description	Qty	UOM	GN1285A0	NTC TEMPERATUR E PROBE SEALING	2.000	PC	SL1045A0	S57 BLACK SILICONE - 80ml CARTRIDGE	1.000	PC	TR1002A1		1.000	PC	VI1220A1	4,2x12 TCB SELF-TAPPIN G SCREW	2.000	PC	VM1465A1	CT BT TEMPERATUR E PROBE COVER	1.000	PC							
Code	Description	Qty	UOM																														
GN1285A0	NTC TEMPERATUR E PROBE SEALING	2.000	PC																														
SL1045A0	S57 BLACK SILICONE - 80ml CARTRIDGE	1.000	PC																														
TR1002A1		1.000	PC																														
VI1220A1	4,2x12 TCB SELF-TAPPIN G SCREW	2.000	PC																														
VM1465A1	CT BT TEMPERATUR E PROBE COVER	1.000	PC																														
TR1106B	PT100 L=2000 TEMPERATURE PROBE		KTR1106B	MIND.Maps L2000 CHAMBER TEMP. PROBE KIT	<table border="1"> <thead> <tr> <th>Code</th> <th>Description</th> <th>Qty</th> <th>UOM</th> </tr> </thead> <tbody> <tr> <td>GN1285A0</td> <td>NTC TEMPERATUR E PROBE SEALING</td> <td>1.000</td> <td>PC</td> </tr> <tr> <td>SL1045A0</td> <td>S57 BLACK SILICONE - 80ml CARTRIDGE</td> <td>1.000</td> <td>PC</td> </tr> <tr> <td>TR1106B0</td> <td>PT100 L=2000 TEMPERATUR E PROBE</td> <td>1.000</td> <td>PC</td> </tr> <tr> <td>VI1220A1</td> <td>4,2x12 TCB SELF-TAPPIN G SCREW</td> <td>2.000</td> <td>PC</td> </tr> <tr> <td>VM1464A1</td> <td>CT BT TEMPERATUR E PROBE COVER</td> <td>1.000</td> <td>PC</td> </tr> <tr> <td>VM1465A1</td> <td>CT BT TEMPERATUR E PROBE COVER</td> <td>1.000</td> <td>PC</td> </tr> </tbody> </table>	Code	Description	Qty	UOM	GN1285A0	NTC TEMPERATUR E PROBE SEALING	1.000	PC	SL1045A0	S57 BLACK SILICONE - 80ml CARTRIDGE	1.000	PC	TR1106B0	PT100 L=2000 TEMPERATUR E PROBE	1.000	PC	VI1220A1	4,2x12 TCB SELF-TAPPIN G SCREW	2.000	PC	VM1464A1	CT BT TEMPERATUR E PROBE COVER	1.000	PC	VM1465A1	CT BT TEMPERATUR E PROBE COVER	1.000	PC
Code	Description	Qty	UOM																														
GN1285A0	NTC TEMPERATUR E PROBE SEALING	1.000	PC																														
SL1045A0	S57 BLACK SILICONE - 80ml CARTRIDGE	1.000	PC																														
TR1106B0	PT100 L=2000 TEMPERATUR E PROBE	1.000	PC																														
VI1220A1	4,2x12 TCB SELF-TAPPIN G SCREW	2.000	PC																														
VM1464A1	CT BT TEMPERATUR E PROBE COVER	1.000	PC																														
VM1465A1	CT BT TEMPERATUR E PROBE COVER	1.000	PC																														





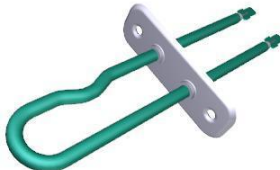

COMPONENT			SPARE PART																						
Code	Description	Image	Code	Description	Kit components																				
VM1464A	CT BT TEMPERATURE PROBE COVER		KVM1464A	CT BT TEMPERATURE PROBE COVER KIT	<table border="1"> <thead> <tr> <th>Code</th> <th>Description</th> <th>Qty</th> <th>UOM</th> </tr> </thead> <tbody> <tr> <td>VM1464A1</td> <td>CT BT TEMPERATUR E PROBE COVER</td> <td>1.000</td> <td>PC</td> </tr> </tbody> </table>	Code	Description	Qty	UOM	VM1464A1	CT BT TEMPERATUR E PROBE COVER	1.000	PC												
Code	Description	Qty	UOM																						
VM1464A1	CT BT TEMPERATUR E PROBE COVER	1.000	PC																						
GN1588A	78x28 G6.25 HEATING ELEMENT GASKET		KG1588A	HEATING ELEMENT 78x28 GASKET 2PCS KIT	<table border="1"> <thead> <tr> <th>Code</th> <th>Description</th> <th>Qty</th> <th>UOM</th> </tr> </thead> <tbody> <tr> <td>GN1588A0</td> <td>78x28 G6.25 HEATING ELEMENT GASKET</td> <td>2.000</td> <td>PC</td> </tr> </tbody> </table>	Code	Description	Qty	UOM	GN1588A0	78x28 G6.25 HEATING ELEMENT GASKET	2.000	PC												
Code	Description	Qty	UOM																						
GN1588A0	78x28 G6.25 HEATING ELEMENT GASKET	2.000	PC																						
RS1277A	100W 60V 1 TURN HEAT ELEMENT KIT		KRS1277A	100W 60V SMOKER ELEMENT KIT	<table border="1"> <thead> <tr> <th>Code</th> <th>Description</th> <th>Qty</th> <th>UOM</th> </tr> </thead> <tbody> <tr> <td>GN1588A0</td> <td>78x28 G6.25 HEATING ELEMENT GASKET</td> <td>1.000</td> <td>PC</td> </tr> <tr> <td>RS1277A0</td> <td>100W 60V 1 TURN HEAT ELEMENT KIT</td> <td>1.000</td> <td>PC</td> </tr> <tr> <td>SL1045A0</td> <td>S57 BLACK SILICONE - 80ml CARTRIDGE</td> <td>1.000</td> <td>PC</td> </tr> <tr> <td>VI1220A1</td> <td>4,2x12 TCB SELF-TAPPIN G SCREW</td> <td>2.000</td> <td>PC</td> </tr> </tbody> </table>	Code	Description	Qty	UOM	GN1588A0	78x28 G6.25 HEATING ELEMENT GASKET	1.000	PC	RS1277A0	100W 60V 1 TURN HEAT ELEMENT KIT	1.000	PC	SL1045A0	S57 BLACK SILICONE - 80ml CARTRIDGE	1.000	PC	VI1220A1	4,2x12 TCB SELF-TAPPIN G SCREW	2.000	PC
Code	Description	Qty	UOM																						
GN1588A0	78x28 G6.25 HEATING ELEMENT GASKET	1.000	PC																						
RS1277A0	100W 60V 1 TURN HEAT ELEMENT KIT	1.000	PC																						
SL1045A0	S57 BLACK SILICONE - 80ml CARTRIDGE	1.000	PC																						
VI1220A1	4,2x12 TCB SELF-TAPPIN G SCREW	2.000	PC																						
VM2416A	SMOKER LOCKING GUIDE PIN		VM2416A0	SMOKER LOCKING GUIDE PIN																					







COMPONENT			SPARE PART																						
Code	Description	Image	Code	Description	Kit components																				
GN1672A	BREAKING ELEMENT GASKET		KG1672A	71x19 HEATING ELEMENT GASKET 5 PCS KIT	<table border="1"> <thead> <tr> <th>Code</th> <th>Description</th> <th>Qty</th> <th>UOM</th> </tr> </thead> <tbody> <tr> <td>GN1672A1</td> <td>BREAKING ELEMENT GASKET</td> <td>5.000</td> <td>PC</td> </tr> </tbody> </table>	Code	Description	Qty	UOM	GN1672A1	BREAKING ELEMENT GASKET	5.000	PC												
Code	Description	Qty	UOM																						
GN1672A1	BREAKING ELEMENT GASKET	5.000	PC																						
RS1034A	147W 105V 1 TURN FLAT ELEMENT		KRS1034A	MM 147W MOTOR BRAKING ELEMENT KIT	<table border="1"> <thead> <tr> <th>Code</th> <th>Description</th> <th>Qty</th> <th>UOM</th> </tr> </thead> <tbody> <tr> <td>GN1672A1</td> <td>BREAKING ELEMENT GASKET</td> <td>1.000</td> <td>PC</td> </tr> <tr> <td>RS1034A0</td> <td>147W 105V 1 TURN FLAT ELEMENT</td> <td>1.000</td> <td>PC</td> </tr> <tr> <td>SL1045A0</td> <td>S57 BLACK SILICONE - 80ml CARTRIDGE</td> <td>1.000</td> <td>PC</td> </tr> <tr> <td>VI1220A1</td> <td>4,2x12 TCB SELF-TAPPIN G SCREW</td> <td>2.000</td> <td>PC</td> </tr> </tbody> </table>	Code	Description	Qty	UOM	GN1672A1	BREAKING ELEMENT GASKET	1.000	PC	RS1034A0	147W 105V 1 TURN FLAT ELEMENT	1.000	PC	SL1045A0	S57 BLACK SILICONE - 80ml CARTRIDGE	1.000	PC	VI1220A1	4,2x12 TCB SELF-TAPPIN G SCREW	2.000	PC
Code	Description	Qty	UOM																						
GN1672A1	BREAKING ELEMENT GASKET	1.000	PC																						
RS1034A0	147W 105V 1 TURN FLAT ELEMENT	1.000	PC																						
SL1045A0	S57 BLACK SILICONE - 80ml CARTRIDGE	1.000	PC																						
VI1220A1	4,2x12 TCB SELF-TAPPIN G SCREW	2.000	PC																						
GN1672A	BREAKING ELEMENT GASKET		KG1672A	71x19 HEATING ELEMENT GASKET 5 PCS KIT	<table border="1"> <thead> <tr> <th>Code</th> <th>Description</th> <th>Qty</th> <th>UOM</th> </tr> </thead> <tbody> <tr> <td>GN1672A1</td> <td>BREAKING ELEMENT GASKET</td> <td>5.000</td> <td>PC</td> </tr> </tbody> </table>	Code	Description	Qty	UOM	GN1672A1	BREAKING ELEMENT GASKET	5.000	PC												
Code	Description	Qty	UOM																						
GN1672A1	BREAKING ELEMENT GASKET	5.000	PC																						
RS1036A	100W 60V 1 TURN FLAT ELEMENT		KRS1036A	MM GAS 100W MOTOR BRAKING ELEMENT KIT	<table border="1"> <thead> <tr> <th>Code</th> <th>Description</th> <th>Qty</th> <th>UOM</th> </tr> </thead> <tbody> <tr> <td>GN1672A1</td> <td>BREAKING ELEMENT GASKET</td> <td>1.000</td> <td>PC</td> </tr> <tr> <td>RS1036A0</td> <td>100W 60V 1 TURN FLAT ELEMENT</td> <td>1.000</td> <td>PC</td> </tr> <tr> <td>SL1045A0</td> <td>S57 BLACK SILICONE - 80ml CARTRIDGE</td> <td>1.000</td> <td>PC</td> </tr> <tr> <td>VI1220A1</td> <td>4,2x12 TCB SELF-TAPPIN G SCREW</td> <td>2.000</td> <td>PC</td> </tr> </tbody> </table>	Code	Description	Qty	UOM	GN1672A1	BREAKING ELEMENT GASKET	1.000	PC	RS1036A0	100W 60V 1 TURN FLAT ELEMENT	1.000	PC	SL1045A0	S57 BLACK SILICONE - 80ml CARTRIDGE	1.000	PC	VI1220A1	4,2x12 TCB SELF-TAPPIN G SCREW	2.000	PC
Code	Description	Qty	UOM																						
GN1672A1	BREAKING ELEMENT GASKET	1.000	PC																						
RS1036A0	100W 60V 1 TURN FLAT ELEMENT	1.000	PC																						
SL1045A0	S57 BLACK SILICONE - 80ml CARTRIDGE	1.000	PC																						
VI1220A1	4,2x12 TCB SELF-TAPPIN G SCREW	2.000	PC																						







COMPONENT			SPARE PART																														
Code	Description	Image	Code	Description	Kit components																												
0H4305A	ST. STEEL MOTOR SHAFT SEALING DIS		K0H4305A	SEALING DISC FOR MOTOR SHAFT KIT	<table border="1"> <thead> <tr> <th>Code</th> <th>Description</th> <th>Qty</th> <th>UOM</th> </tr> </thead> <tbody> <tr> <td>0H8118A0</td> <td>XEVL MOTOR SHAFT DISC</td> <td>1.000</td> <td>PC</td> </tr> <tr> <td>GN1140A3</td> <td>MOLDED MOTOR HOLDER GASKET</td> <td>1.000</td> <td>PC</td> </tr> <tr> <td>SL1045A0</td> <td>S57 BLACK SILICONE - 80ml CARTRIDGE</td> <td>1.000</td> <td>PC</td> </tr> <tr> <td>VI1220A1</td> <td>4.2x12 TCB SELF-TAPPIN G SCREW</td> <td>3.000</td> <td>PC</td> </tr> </tbody> </table>	Code	Description	Qty	UOM	0H8118A0	XEVL MOTOR SHAFT DISC	1.000	PC	GN1140A3	MOLDED MOTOR HOLDER GASKET	1.000	PC	SL1045A0	S57 BLACK SILICONE - 80ml CARTRIDGE	1.000	PC	VI1220A1	4.2x12 TCB SELF-TAPPIN G SCREW	3.000	PC								
					Code	Description	Qty	UOM																									
					0H8118A0	XEVL MOTOR SHAFT DISC	1.000	PC																									
					GN1140A3	MOLDED MOTOR HOLDER GASKET	1.000	PC																									
SL1045A0	S57 BLACK SILICONE - 80ml CARTRIDGE	1.000	PC																														
VI1220A1	4.2x12 TCB SELF-TAPPIN G SCREW	3.000	PC																														
0H7170A	MM MOTOR GLASS WOOL PLATE		0H7170A0	MM MOTOR GLASS WOOL PLATE																													
GN1140A	MOLDED MOTOR HOLDER GASKET		KGN1140A	5 PCS. MOTOR HOLDER GASKET KI	<table border="1"> <thead> <tr> <th>Code</th> <th>Description</th> <th>Qty</th> <th>UOM</th> </tr> </thead> <tbody> <tr> <td>GN1140A3</td> <td>MOLDED MOTOR HOLDER GASKET</td> <td>5.000</td> <td>PC</td> </tr> </tbody> </table>	Code	Description	Qty	UOM	GN1140A3	MOLDED MOTOR HOLDER GASKET	5.000	PC																				
					Code	Description	Qty	UOM																									
GN1140A3	MOLDED MOTOR HOLDER GASKET	5.000	PC																														
MT1012A	330W 230V MOTOR		KVN1130A	LUX ≤08.2017/L.MISS/S.5/ 5E MOTOR KIT	<table border="1"> <thead> <tr> <th>Code</th> <th>Description</th> <th>Qty</th> <th>UOM</th> </tr> </thead> <tbody> <tr> <td>0H8118A0</td> <td>XEVL MOTOR SHAFT DISC</td> <td>1.000</td> <td>PC</td> </tr> <tr> <td>GN1140A3</td> <td>MOLDED MOTOR HOLDER GASKET</td> <td>1.000</td> <td>PC</td> </tr> <tr> <td>VI1034A0</td> <td>STAINLESS STEEL WASHER 8.4x16x1</td> <td>1.000</td> <td>PC</td> </tr> <tr> <td>VI1256A0</td> <td>M8 DIN 980M ST. STEEL SELF LOCKING NUT</td> <td>1.000</td> <td>PC</td> </tr> <tr> <td>VM2196A0</td> <td>MOTOR NUT FASTENING BUSHING</td> <td>1.000</td> <td>PC</td> </tr> <tr> <td>VN1130A1</td> <td>330W 230V 50/60HZ MOTO</td> <td>1.000</td> <td>PC</td> </tr> </tbody> </table>	Code	Description	Qty	UOM	0H8118A0	XEVL MOTOR SHAFT DISC	1.000	PC	GN1140A3	MOLDED MOTOR HOLDER GASKET	1.000	PC	VI1034A0	STAINLESS STEEL WASHER 8.4x16x1	1.000	PC	VI1256A0	M8 DIN 980M ST. STEEL SELF LOCKING NUT	1.000	PC	VM2196A0	MOTOR NUT FASTENING BUSHING	1.000	PC	VN1130A1	330W 230V 50/60HZ MOTO	1.000	PC
					Code	Description	Qty	UOM																									
					0H8118A0	XEVL MOTOR SHAFT DISC	1.000	PC																									
					GN1140A3	MOLDED MOTOR HOLDER GASKET	1.000	PC																									
					VI1034A0	STAINLESS STEEL WASHER 8.4x16x1	1.000	PC																									
					VI1256A0	M8 DIN 980M ST. STEEL SELF LOCKING NUT	1.000	PC																									
					VM2196A0	MOTOR NUT FASTENING BUSHING	1.000	PC																									
VN1130A1	330W 230V 50/60HZ MOTO	1.000	PC																														

COMPONENT			SPARE PART																																						
Code	Description	Image	Code	Description	Kit components																																				
MT1012A	330W 230V MOTOR		KMT1012A	LUX >08.2017 / MIND.MAPS 330W MOTOR KIT	<table border="1"> <thead> <tr> <th>Code</th> <th>Description</th> <th>Qty</th> <th>UOM</th> </tr> </thead> <tbody> <tr> <td>0H2842A0</td> <td>MT1012 CENTERING JI</td> <td>1.000</td> <td>PC</td> </tr> <tr> <td>0H8118A0</td> <td>XEVL MOTOR SHAFT DISC</td> <td>1.000</td> <td>PC</td> </tr> <tr> <td>GN1140A3</td> <td>MOLDED MOTOR HOLDER GASKET</td> <td>1.000</td> <td>PC</td> </tr> <tr> <td>MT1012A0</td> <td>330W 230V MOTOR</td> <td>1.000</td> <td>PC</td> </tr> <tr> <td>VI1077A1</td> <td>SCREW M6x12 TE INOX</td> <td>1.000</td> <td>PC</td> </tr> <tr> <td>VI1521A0</td> <td>STAINLESS STEEL WASHER D=6 6592</td> <td>1.000</td> <td>PC</td> </tr> <tr> <td>VI1966A1</td> <td>M4x14 FLATHEAD SCREW</td> <td>1.000</td> <td>PC</td> </tr> </tbody> </table>	Code	Description	Qty	UOM	0H2842A0	MT1012 CENTERING JI	1.000	PC	0H8118A0	XEVL MOTOR SHAFT DISC	1.000	PC	GN1140A3	MOLDED MOTOR HOLDER GASKET	1.000	PC	MT1012A0	330W 230V MOTOR	1.000	PC	VI1077A1	SCREW M6x12 TE INOX	1.000	PC	VI1521A0	STAINLESS STEEL WASHER D=6 6592	1.000	PC	VI1966A1	M4x14 FLATHEAD SCREW	1.000	PC				
					Code	Description	Qty	UOM																																	
					0H2842A0	MT1012 CENTERING JI	1.000	PC																																	
					0H8118A0	XEVL MOTOR SHAFT DISC	1.000	PC																																	
					GN1140A3	MOLDED MOTOR HOLDER GASKET	1.000	PC																																	
					MT1012A0	330W 230V MOTOR	1.000	PC																																	
					VI1077A1	SCREW M6x12 TE INOX	1.000	PC																																	
					VI1521A0	STAINLESS STEEL WASHER D=6 6592	1.000	PC																																	
					VI1966A1	M4x14 FLATHEAD SCREW	1.000	PC																																	
					VN1184A	D195 H80 8 CONCAVE BLADES FAN		KVN1184A	D195 H80 8 CONCAVE BLADES FAN KIT	<table border="1"> <thead> <tr> <th>Code</th> <th>Description</th> <th>Qty</th> <th>UOM</th> </tr> </thead> <tbody> <tr> <td>V1122A0</td> <td>A4 316 M6X12 SCREW</td> <td>1.000</td> <td>PC</td> </tr> <tr> <td>V1123A0</td> <td>A4 ST. STEEL FLAT WASHER FOR M6</td> <td>1.000</td> <td>PC</td> </tr> <tr> <td>VN1184A0</td> <td>D195 H80 8 CONCAVE BLADES FAN</td> <td>1.000</td> <td>PC</td> </tr> </tbody> </table>	Code	Description	Qty	UOM	V1122A0	A4 316 M6X12 SCREW	1.000	PC	V1123A0	A4 ST. STEEL FLAT WASHER FOR M6	1.000	PC	VN1184A0	D195 H80 8 CONCAVE BLADES FAN	1.000	PC															
Code	Description	Qty	UOM																																						
V1122A0	A4 316 M6X12 SCREW	1.000	PC																																						
V1123A0	A4 ST. STEEL FLAT WASHER FOR M6	1.000	PC																																						
VN1184A0	D195 H80 8 CONCAVE BLADES FAN	1.000	PC																																						
SN1002B	L2050 MULTIPOINT CORE PROBE WITHOUT NUT		KSN1020B	US MULTIPOINT L2050 CORE PROBE KIT	<table border="1"> <thead> <tr> <th>Code</th> <th>Description</th> <th>Qty</th> <th>UOM</th> </tr> </thead> <tbody> <tr> <td>0H8035A0</td> <td>MM CORE PROBE ACCESS COVE</td> <td>1.000</td> <td>PC</td> </tr> <tr> <td>CE1037A0</td> <td>UL SILICONE GLASS FIBER SHEATH</td> <td>0.700</td> <td>M</td> </tr> <tr> <td>CE1685A0</td> <td>MRT8 P3,81 5 POLES FEMALE TERMINAL</td> <td>1.000</td> <td>PC</td> </tr> <tr> <td>GN1632A0</td> <td>CORE PROBE INLET GASKET</td> <td>1.000</td> <td>PC</td> </tr> <tr> <td>RC1130A0</td> <td>130x2.6 CLAM</td> <td>2.000</td> <td>PC</td> </tr> <tr> <td>SL1045A0</td> <td>S57 BLACK SILICONE - 80ml CARTRIDGE</td> <td>1.000</td> <td>PC</td> </tr> <tr> <td>SN1002B1</td> <td>L2050 MULTIPOINT CORE PROBE WITHOUT NUT</td> <td>1.000</td> <td>PC</td> </tr> <tr> <td>V11220A1</td> <td>4,2x12 TCB SELF-TAPPIN G SCREW</td> <td>3.000</td> <td>PC</td> </tr> </tbody> </table>	Code	Description	Qty	UOM	0H8035A0	MM CORE PROBE ACCESS COVE	1.000	PC	CE1037A0	UL SILICONE GLASS FIBER SHEATH	0.700	M	CE1685A0	MRT8 P3,81 5 POLES FEMALE TERMINAL	1.000	PC	GN1632A0	CORE PROBE INLET GASKET	1.000	PC	RC1130A0	130x2.6 CLAM	2.000	PC	SL1045A0	S57 BLACK SILICONE - 80ml CARTRIDGE	1.000	PC	SN1002B1	L2050 MULTIPOINT CORE PROBE WITHOUT NUT	1.000	PC	V11220A1	4,2x12 TCB SELF-TAPPIN G SCREW	3.000	PC
					Code	Description	Qty	UOM																																	
					0H8035A0	MM CORE PROBE ACCESS COVE	1.000	PC																																	
					CE1037A0	UL SILICONE GLASS FIBER SHEATH	0.700	M																																	
					CE1685A0	MRT8 P3,81 5 POLES FEMALE TERMINAL	1.000	PC																																	
					GN1632A0	CORE PROBE INLET GASKET	1.000	PC																																	
					RC1130A0	130x2.6 CLAM	2.000	PC																																	
					SL1045A0	S57 BLACK SILICONE - 80ml CARTRIDGE	1.000	PC																																	
					SN1002B1	L2050 MULTIPOINT CORE PROBE WITHOUT NUT	1.000	PC																																	
					V11220A1	4,2x12 TCB SELF-TAPPIN G SCREW	3.000	PC																																	



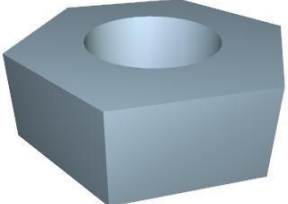

COMPONENT			SPARE PART																														
Code	Description	Image	Code	Description	Kit components																												
SN1002B	L2050 MULTIPOINT CORE PROBE WITHOUT NUT		KSN1002B	MULTIPOINT CORE PROBE KIT L2050	<table border="1"> <thead> <tr> <th>Code</th> <th>Description</th> <th>Qty</th> <th>UOM</th> </tr> </thead> <tbody> <tr> <td>0H8035A0</td> <td>MM CORE PROBE ACCESS COVE</td> <td>1.000</td> <td>PC</td> </tr> <tr> <td>CE1685A0</td> <td>MRT8 P3,81 5 POLES FEMALE TERMINAL</td> <td>1.000</td> <td>PC</td> </tr> <tr> <td>GN1632A0</td> <td>CORE PROBE INLET GASKET</td> <td>1.000</td> <td>PC</td> </tr> <tr> <td>SL1045A0</td> <td>S57 BLACK SILICONE - 80ml CARTRIDGE</td> <td>1.000</td> <td>PC</td> </tr> <tr> <td>SN1002B1</td> <td>L2050 MULTIPOINT CORE PROBE WITHOUT NUT</td> <td>1.000</td> <td>PC</td> </tr> <tr> <td>VI1220A1</td> <td>4,2x12 TCB SELF-TAPPIN G SCREW</td> <td>3.000</td> <td>PC</td> </tr> </tbody> </table>	Code	Description	Qty	UOM	0H8035A0	MM CORE PROBE ACCESS COVE	1.000	PC	CE1685A0	MRT8 P3,81 5 POLES FEMALE TERMINAL	1.000	PC	GN1632A0	CORE PROBE INLET GASKET	1.000	PC	SL1045A0	S57 BLACK SILICONE - 80ml CARTRIDGE	1.000	PC	SN1002B1	L2050 MULTIPOINT CORE PROBE WITHOUT NUT	1.000	PC	VI1220A1	4,2x12 TCB SELF-TAPPIN G SCREW	3.000	PC
					Code	Description	Qty	UOM																									
					0H8035A0	MM CORE PROBE ACCESS COVE	1.000	PC																									
					CE1685A0	MRT8 P3,81 5 POLES FEMALE TERMINAL	1.000	PC																									
					GN1632A0	CORE PROBE INLET GASKET	1.000	PC																									
					SL1045A0	S57 BLACK SILICONE - 80ml CARTRIDGE	1.000	PC																									
					SN1002B1	L2050 MULTIPOINT CORE PROBE WITHOUT NUT	1.000	PC																									
VI1220A1	4,2x12 TCB SELF-TAPPIN G SCREW	3.000	PC																														
GRL1399A	GRL1399A2		KGRL1399A	10 TRAYS GN1/1 LATERAL SUPPORTS KIT	<table border="1"> <thead> <tr> <th>Code</th> <th>Description</th> <th>Qty</th> <th>UOM</th> </tr> </thead> <tbody> <tr> <td>0H7346B0</td> <td></td> <td>1.000</td> <td>PC</td> </tr> <tr> <td>0H7347B0</td> <td></td> <td>1.000</td> <td>PC</td> </tr> <tr> <td>GRL1399A2</td> <td>GRL1399A2</td> <td>1.000</td> <td>PC</td> </tr> <tr> <td>GRL1400A2</td> <td>GRL1400A2</td> <td>1.000</td> <td>PC</td> </tr> </tbody> </table>	Code	Description	Qty	UOM	0H7346B0		1.000	PC	0H7347B0		1.000	PC	GRL1399A2	GRL1399A2	1.000	PC	GRL1400A2	GRL1400A2	1.000	PC								
					Code	Description	Qty	UOM																									
					0H7346B0		1.000	PC																									
					0H7347B0		1.000	PC																									
					GRL1399A2	GRL1399A2	1.000	PC																									
GRL1400A2	GRL1400A2	1.000	PC																														
GRL1400A	GRL1400A2		KGRL1399A	10 TRAYS GN1/1 LATERAL SUPPORTS KIT	<table border="1"> <thead> <tr> <th>Code</th> <th>Description</th> <th>Qty</th> <th>UOM</th> </tr> </thead> <tbody> <tr> <td>0H7346B0</td> <td></td> <td>1.000</td> <td>PC</td> </tr> <tr> <td>0H7347B0</td> <td></td> <td>1.000</td> <td>PC</td> </tr> <tr> <td>GRL1399A2</td> <td>GRL1399A2</td> <td>1.000</td> <td>PC</td> </tr> <tr> <td>GRL1400A2</td> <td>GRL1400A2</td> <td>1.000</td> <td>PC</td> </tr> </tbody> </table>	Code	Description	Qty	UOM	0H7346B0		1.000	PC	0H7347B0		1.000	PC	GRL1399A2	GRL1399A2	1.000	PC	GRL1400A2	GRL1400A2	1.000	PC								
					Code	Description	Qty	UOM																									
					0H7346B0		1.000	PC																									
					0H7347B0		1.000	PC																									
					GRL1399A2	GRL1399A2	1.000	PC																									
GRL1400A2	GRL1400A2	1.000	PC																														
RC1019A	D=10 ELASTIC CLAM		KRC1019A	Ø10 ZINC PLATED ELASTIC CLAMP 15 PCS KIT	<table border="1"> <thead> <tr> <th>Code</th> <th>Description</th> <th>Qty</th> <th>UOM</th> </tr> </thead> <tbody> <tr> <td>RC1019A0</td> <td>D=10 ELASTIC CLAMP</td> <td>15.000</td> <td>PC</td> </tr> </tbody> </table>	Code	Description	Qty	UOM	RC1019A0	D=10 ELASTIC CLAMP	15.000	PC																				
					Code	Description	Qty	UOM																									
RC1019A0	D=10 ELASTIC CLAMP	15.000	PC																														



COMPONENT			SPARE PART														
Code	Description	Image	Code	Description	Kit components												
VL1037A	WASHING SYSTEM ROTOR ARM		KVL1037A	WASHING SYSTEM ROTOR ARM KIT	<table border="1"> <thead> <tr> <th>Code</th> <th>Description</th> <th>Qty</th> <th>UOM</th> </tr> </thead> <tbody> <tr> <td>VL1037A3</td> <td>WASHING SYSTEM ROTOR ARM</td> <td>1.000</td> <td>PC</td> </tr> </tbody> </table>	Code	Description	Qty	UOM	VL1037A3	WASHING SYSTEM ROTOR ARM	1.000	PC				
Code	Description	Qty	UOM														
VL1037A3	WASHING SYSTEM ROTOR ARM	1.000	PC														
VL1127A	6mm BARBED T-SHAPED FITTING		KVL1127A	6mm BARBED T-SHAPED FITTING 10 PCS KIT	<table border="1"> <thead> <tr> <th>Code</th> <th>Description</th> <th>Qty</th> <th>UOM</th> </tr> </thead> <tbody> <tr> <td>VL1127A1</td> <td>6mm BARBED T-SHAPED FITTING</td> <td>10.000</td> <td>PC</td> </tr> </tbody> </table>	Code	Description	Qty	UOM	VL1127A1	6mm BARBED T-SHAPED FITTING	10.000	PC				
Code	Description	Qty	UOM														
VL1127A1	6mm BARBED T-SHAPED FITTING	10.000	PC														
TB3253A	TB3131A-T SHAPED EXT HUM PIPE CONNECTION		KTB3131A	WHITE-BLACK 6X12 STEAM PIPE 3M KIT	<table border="1"> <thead> <tr> <th>Code</th> <th>Description</th> <th>Qty</th> <th>UOM</th> </tr> </thead> <tbody> <tr> <td>TB3131A0</td> <td>WHITE-BLACK EPDM TEXTILE BRAID HOSE 6x12</td> <td>3.000</td> <td>M</td> </tr> <tr> <td>VM1794A0</td> <td>250x4.8 PA66 BLACK CLAMP</td> <td>1.000</td> <td>PC</td> </tr> </tbody> </table>	Code	Description	Qty	UOM	TB3131A0	WHITE-BLACK EPDM TEXTILE BRAID HOSE 6x12	3.000	M	VM1794A0	250x4.8 PA66 BLACK CLAMP	1.000	PC
Code	Description	Qty	UOM														
TB3131A0	WHITE-BLACK EPDM TEXTILE BRAID HOSE 6x12	3.000	M														
VM1794A0	250x4.8 PA66 BLACK CLAMP	1.000	PC														
RC1170A	M14 H=7 CH=22 STAINLESS STEEL NUT		KRC1170A	M14 H8 CH22 NUT - 10 PCS. KIT	<table border="1"> <thead> <tr> <th>Code</th> <th>Description</th> <th>Qty</th> <th>UOM</th> </tr> </thead> <tbody> <tr> <td>RC1170A1</td> <td>M14 H=7 CH=22 STAINLESS STEEL NUT</td> <td>10.000</td> <td>PC</td> </tr> </tbody> </table>	Code	Description	Qty	UOM	RC1170A1	M14 H=7 CH=22 STAINLESS STEEL NUT	10.000	PC				
Code	Description	Qty	UOM														
RC1170A1	M14 H=7 CH=22 STAINLESS STEEL NUT	10.000	PC														
TB2909B	XEVC EXTERNAL WATER PIPE D10 +CONNECTION		KTB2909B	Ø10 EXT WATER PIPE KIT XEVC GAS PLUS	<table border="1"> <thead> <tr> <th>Code</th> <th>Description</th> <th>Qty</th> <th>UOM</th> </tr> </thead> <tbody> <tr> <td>TB2909B0</td> <td>XEVC EXTERNAL WATER PIPE D10 +CONNECTIO</td> <td>1.000</td> <td>PC</td> </tr> </tbody> </table>	Code	Description	Qty	UOM	TB2909B0	XEVC EXTERNAL WATER PIPE D10 +CONNECTIO	1.000	PC				
Code	Description	Qty	UOM														
TB2909B0	XEVC EXTERNAL WATER PIPE D10 +CONNECTIO	1.000	PC														



COMPONENT			SPARE PART																																		
Code	Description	Image	Code	Description	Kit components																																
ON1424E	ON1424E0		KON1424E	1011 HEAT EXCHANGER KIT	<table border="1"> <thead> <tr> <th>Code</th> <th>Description</th> <th>Qty</th> <th>UOM</th> </tr> </thead> <tbody> <tr> <td>0H7741B0</td> <td>HEAT EXCH TIE ROD ANTI ROTATION PLATE</td> <td>2.000</td> <td>PC</td> </tr> <tr> <td>ON1424E0</td> <td>ON1424E0</td> <td>1.000</td> <td>PC</td> </tr> <tr> <td>ON1503A2</td> <td>HEAT EXCHANGER INTERNAL RIN</td> <td>2.000</td> <td>PC</td> </tr> <tr> <td>GN1580B0</td> <td>M8 TIE ROD GASKET</td> <td>2.000</td> <td>PC</td> </tr> <tr> <td>RC1175A2</td> <td>SPRING TENSION WITH HOOKS DE=11</td> <td>1.000</td> <td>PC</td> </tr> <tr> <td>SL1045A0</td> <td>S57 BLACK SILICONE - 80ml CARTRIDGE</td> <td>1.000</td> <td>PC</td> </tr> <tr> <td>VI2018A0</td> <td>M6x1 H6 CH10 BRASS NUT</td> <td>4.000</td> <td>PC</td> </tr> </tbody> </table>	Code	Description	Qty	UOM	0H7741B0	HEAT EXCH TIE ROD ANTI ROTATION PLATE	2.000	PC	ON1424E0	ON1424E0	1.000	PC	ON1503A2	HEAT EXCHANGER INTERNAL RIN	2.000	PC	GN1580B0	M8 TIE ROD GASKET	2.000	PC	RC1175A2	SPRING TENSION WITH HOOKS DE=11	1.000	PC	SL1045A0	S57 BLACK SILICONE - 80ml CARTRIDGE	1.000	PC	VI2018A0	M6x1 H6 CH10 BRASS NUT	4.000	PC
Code	Description	Qty	UOM																																		
0H7741B0	HEAT EXCH TIE ROD ANTI ROTATION PLATE	2.000	PC																																		
ON1424E0	ON1424E0	1.000	PC																																		
ON1503A2	HEAT EXCHANGER INTERNAL RIN	2.000	PC																																		
GN1580B0	M8 TIE ROD GASKET	2.000	PC																																		
RC1175A2	SPRING TENSION WITH HOOKS DE=11	1.000	PC																																		
SL1045A0	S57 BLACK SILICONE - 80ml CARTRIDGE	1.000	PC																																		
VI2018A0	M6x1 H6 CH10 BRASS NUT	4.000	PC																																		
ON1503A	HEAT EXCHANGER INTERNAL RING		XRF013	MM HEAT EXCHANGERS SEALING RETROFIT KIT	<table border="1"> <thead> <tr> <th>Code</th> <th>Description</th> <th>Qty</th> <th>UOM</th> </tr> </thead> <tbody> <tr> <td>ON1503A2</td> <td>HEAT EXCHANGER INTERNAL RIN</td> <td>4.000</td> <td>PC</td> </tr> </tbody> </table>	Code	Description	Qty	UOM	ON1503A2	HEAT EXCHANGER INTERNAL RIN	4.000	PC																								
			Code	Description	Qty	UOM																															
ON1503A2	HEAT EXCHANGER INTERNAL RIN	4.000	PC																																		
KON1503A	HEAT EXCHANGER INTERNAL RING 2 PCS KIT	<table border="1"> <thead> <tr> <th>Code</th> <th>Description</th> <th>Qty</th> <th>UOM</th> </tr> </thead> <tbody> <tr> <td>ON1503A2</td> <td>HEAT EXCHANGER INTERNAL RIN</td> <td>2.000</td> <td>PC</td> </tr> </tbody> </table>	Code	Description	Qty	UOM	ON1503A2	HEAT EXCHANGER INTERNAL RIN	2.000	PC																											
Code	Description	Qty	UOM																																		
ON1503A2	HEAT EXCHANGER INTERNAL RIN	2.000	PC																																		
GN1544A	AIR INLET GASKET		KTB3128A	XECC-1013-E VENTURI COLLECTOR PIPE KI	<table border="1"> <thead> <tr> <th>Code</th> <th>Description</th> <th>Qty</th> <th>UOM</th> </tr> </thead> <tbody> <tr> <td>GN1544A0</td> <td>AIR INLET GASKET</td> <td>1.000</td> <td>PC</td> </tr> <tr> <td>GN1584A0</td> <td>CORNER FITTING D30-D16</td> <td>1.000</td> <td>PC</td> </tr> <tr> <td>TB3128A0</td> <td>XECC-10 VENTURI AIR EXIT PIPE</td> <td>1.000</td> <td>PC</td> </tr> </tbody> </table>	Code	Description	Qty	UOM	GN1544A0	AIR INLET GASKET	1.000	PC	GN1584A0	CORNER FITTING D30-D16	1.000	PC	TB3128A0	XECC-10 VENTURI AIR EXIT PIPE	1.000	PC																
				Code	Description	Qty	UOM																														
				GN1544A0	AIR INLET GASKET	1.000	PC																														
			GN1584A0	CORNER FITTING D30-D16	1.000	PC																															
			TB3128A0	XECC-10 VENTURI AIR EXIT PIPE	1.000	PC																															
			KTB3074B	XEVC-0711-G VENTURI COLLECTOR PIPE KI	<table border="1"> <thead> <tr> <th>Code</th> <th>Description</th> <th>Qty</th> <th>UOM</th> </tr> </thead> <tbody> <tr> <td>GN1544A0</td> <td>AIR INLET GASKET</td> <td>1.000</td> <td>PC</td> </tr> <tr> <td>GN1584A0</td> <td>CORNER FITTING D30-D16</td> <td>1.000</td> <td>PC</td> </tr> <tr> <td>RC1042A0</td> <td>DOUBLE WIRE SPRING CLAMP D21.5-22.6</td> <td>1.000</td> <td>PC</td> </tr> </tbody> </table>	Code	Description	Qty	UOM	GN1544A0	AIR INLET GASKET	1.000	PC	GN1584A0	CORNER FITTING D30-D16	1.000	PC	RC1042A0	DOUBLE WIRE SPRING CLAMP D21.5-22.6	1.000	PC																
Code	Description	Qty		UOM																																	
GN1544A0	AIR INLET GASKET	1.000		PC																																	
GN1584A0	CORNER FITTING D30-D16	1.000	PC																																		
RC1042A0	DOUBLE WIRE SPRING CLAMP D21.5-22.6	1.000	PC																																		





COMPONENT			SPARE PART																								
Code	Description	Image	Code	Description	Kit components																						
GN1544A	AIR INLET GASKET		KTB3074B	XEVC-0711-G VENTURI COLLECTOR PIPE KI	<table border="1"> <thead> <tr> <th>Code</th> <th>Description</th> <th>Qty</th> <th>UOM</th> </tr> </thead> <tbody> <tr> <td>TB3074B0</td> <td>XEVC-07EU-G VENTURI COLLECTOR PIPE D30</td> <td>1.000</td> <td>PC</td> </tr> <tr> <td>VM1794A0</td> <td>250x4.8 PA66 BLACK CLAMP</td> <td>1.000</td> <td>PC</td> </tr> </tbody> </table>	Code	Description	Qty	UOM	TB3074B0	XEVC-07EU-G VENTURI COLLECTOR PIPE D30	1.000	PC	VM1794A0	250x4.8 PA66 BLACK CLAMP	1.000	PC										
					Code	Description	Qty	UOM																			
					TB3074B0	XEVC-07EU-G VENTURI COLLECTOR PIPE D30	1.000	PC																			
					VM1794A0	250x4.8 PA66 BLACK CLAMP	1.000	PC																			
			<table border="1"> <thead> <tr> <th>Code</th> <th>Description</th> <th>Qty</th> <th>UOM</th> </tr> </thead> <tbody> <tr> <td>GN1544A0</td> <td>AIR INLET GASKET</td> <td>2.000</td> <td>PC</td> </tr> <tr> <td>GN1584A0</td> <td>CORNER FITTING D30-D16</td> <td>1.000</td> <td>PC</td> </tr> <tr> <td>RC1042A0</td> <td>DOUBLE WIRE SPRING CLAMP D21.5-22.6</td> <td>1.000</td> <td>PC</td> </tr> <tr> <td>TB3068B0</td> <td>XEBC-10 VENTURI AIR COLLECTOR PIPE D30</td> <td>1.000</td> <td>PC</td> </tr> <tr> <td>VM1794A0</td> <td>250x4.8 PA66 BLACK CLAMP</td> <td>1.000</td> <td>PC</td> </tr> </tbody> </table>	Code	Description	Qty	UOM	GN1544A0	AIR INLET GASKET	2.000	PC	GN1584A0	CORNER FITTING D30-D16	1.000	PC	RC1042A0	DOUBLE WIRE SPRING CLAMP D21.5-22.6	1.000	PC	TB3068B0	XEBC-10 VENTURI AIR COLLECTOR PIPE D30	1.000	PC	VM1794A0	250x4.8 PA66 BLACK CLAMP	1.000	PC
			Code	Description	Qty	UOM																					
			GN1544A0	AIR INLET GASKET	2.000	PC																					
			GN1584A0	CORNER FITTING D30-D16	1.000	PC																					
			RC1042A0	DOUBLE WIRE SPRING CLAMP D21.5-22.6	1.000	PC																					
			TB3068B0	XEBC-10 VENTURI AIR COLLECTOR PIPE D30	1.000	PC																					
			VM1794A0	250x4.8 PA66 BLACK CLAMP	1.000	PC																					
			<table border="1"> <thead> <tr> <th>Code</th> <th>Description</th> <th>Qty</th> <th>UOM</th> </tr> </thead> <tbody> <tr> <td>GN1544A0</td> <td>AIR INLET GASKET</td> <td>1.000</td> <td>PC</td> </tr> <tr> <td>GN1584A0</td> <td>CORNER FITTING D30-D16</td> <td>1.000</td> <td>PC</td> </tr> <tr> <td>RC1042A0</td> <td>DOUBLE WIRE SPRING CLAMP D21.5-22.6</td> <td>1.000</td> <td>PC</td> </tr> <tr> <td>TB3019A1</td> <td>XEVC-2011 UPPER AIR INLET PIPE D3</td> <td>1.000</td> <td>PC</td> </tr> <tr> <td>VM1794A0</td> <td>250x4.8 PA66 BLACK CLAMP</td> <td>1.000</td> <td>PC</td> </tr> </tbody> </table>	Code	Description	Qty	UOM	GN1544A0	AIR INLET GASKET	1.000	PC	GN1584A0	CORNER FITTING D30-D16	1.000	PC	RC1042A0	DOUBLE WIRE SPRING CLAMP D21.5-22.6	1.000	PC	TB3019A1	XEVC-2011 UPPER AIR INLET PIPE D3	1.000	PC	VM1794A0	250x4.8 PA66 BLACK CLAMP	1.000	PC
Code	Description	Qty	UOM																								
GN1544A0	AIR INLET GASKET	1.000	PC																								
GN1584A0	CORNER FITTING D30-D16	1.000	PC																								
RC1042A0	DOUBLE WIRE SPRING CLAMP D21.5-22.6	1.000	PC																								
TB3019A1	XEVC-2011 UPPER AIR INLET PIPE D3	1.000	PC																								
VM1794A0	250x4.8 PA66 BLACK CLAMP	1.000	PC																								
<table border="1"> <thead> <tr> <th>Code</th> <th>Description</th> <th>Qty</th> <th>UOM</th> </tr> </thead> <tbody> <tr> <td>GN1544A0</td> <td>AIR INLET GASKET</td> <td>2.000</td> <td>PC</td> </tr> <tr> <td>GN1584A0</td> <td>CORNER FITTING D30-D16</td> <td>1.000</td> <td>PC</td> </tr> <tr> <td>RC1042A0</td> <td>DOUBLE WIRE SPRING CLAMP D21.5-22.6</td> <td>1.000</td> <td>PC</td> </tr> <tr> <td>TB2979C0</td> <td>XEBC-10 VENTURI AIR COLLECTOR PIPE D30</td> <td>1.000</td> <td>PC</td> </tr> <tr> <td>VM1794A0</td> <td>250x4.8 PA66 BLACK CLAMP</td> <td>1.000</td> <td>PC</td> </tr> </tbody> </table>	Code	Description	Qty	UOM	GN1544A0	AIR INLET GASKET	2.000	PC	GN1584A0	CORNER FITTING D30-D16	1.000	PC	RC1042A0	DOUBLE WIRE SPRING CLAMP D21.5-22.6	1.000	PC	TB2979C0	XEBC-10 VENTURI AIR COLLECTOR PIPE D30	1.000	PC	VM1794A0	250x4.8 PA66 BLACK CLAMP	1.000	PC			
Code	Description	Qty	UOM																								
GN1544A0	AIR INLET GASKET	2.000	PC																								
GN1584A0	CORNER FITTING D30-D16	1.000	PC																								
RC1042A0	DOUBLE WIRE SPRING CLAMP D21.5-22.6	1.000	PC																								
TB2979C0	XEBC-10 VENTURI AIR COLLECTOR PIPE D30	1.000	PC																								
VM1794A0	250x4.8 PA66 BLACK CLAMP	1.000	PC																								
KTB3068B	10FS/EU/2-G VENTURI COLLECTOR PIPE KI																										
KTB3019A	20XX/16XX UPPER VENTURI COLLECT PIPE KIT																										
KTB2979C	XEBC-10XX-E VENTURI COLLECTOR PIPE KI																										



COMPONENT			SPARE PART																										
Code	Description	Image	Code	Description	Kit components																								
GN1544A	AIR INLET GASKET		KTB2978B	06EU/FS/21 VENTURI COLLECTOR PIPE KI	<table border="1"> <thead> <tr> <th>Code</th> <th>Description</th> <th>Qty</th> <th>UOM</th> </tr> </thead> <tbody> <tr> <td>GN1544A0</td> <td>AIR INLET GASKET</td> <td>1.000</td> <td>PC</td> </tr> <tr> <td>GN1584A0</td> <td>CORNER FITTING D30-D16</td> <td>1.000</td> <td>PC</td> </tr> <tr> <td>RC1042A0</td> <td>DOUBLE WIRE SPRING CLAMP D21.5-22.6</td> <td>1.000</td> <td>PC</td> </tr> <tr> <td>TB2978B0</td> <td>XEBC-06 VENTURI AIR COLLECTOR PIPE D30</td> <td>1.000</td> <td>PC</td> </tr> <tr> <td>VM1794A0</td> <td>250x4.8 PA66 BLACK CLAMP</td> <td>1.000</td> <td>PC</td> </tr> </tbody> </table>	Code	Description	Qty	UOM	GN1544A0	AIR INLET GASKET	1.000	PC	GN1584A0	CORNER FITTING D30-D16	1.000	PC	RC1042A0	DOUBLE WIRE SPRING CLAMP D21.5-22.6	1.000	PC	TB2978B0	XEBC-06 VENTURI AIR COLLECTOR PIPE D30	1.000	PC	VM1794A0	250x4.8 PA66 BLACK CLAMP	1.000	PC
					Code	Description	Qty	UOM																					
					GN1544A0	AIR INLET GASKET	1.000	PC																					
					GN1584A0	CORNER FITTING D30-D16	1.000	PC																					
			RC1042A0	DOUBLE WIRE SPRING CLAMP D21.5-22.6	1.000	PC																							
			TB2978B0	XEBC-06 VENTURI AIR COLLECTOR PIPE D30	1.000	PC																							
			VM1794A0	250x4.8 PA66 BLACK CLAMP	1.000	PC																							
			KTB2959B	XEVC-1011-E VENTURI COLLECTOR PIPE KI	<table border="1"> <thead> <tr> <th>Code</th> <th>Description</th> <th>Qty</th> <th>UOM</th> </tr> </thead> <tbody> <tr> <td>GN1544A0</td> <td>AIR INLET GASKET</td> <td>2.000</td> <td>PC</td> </tr> <tr> <td>GN1584A0</td> <td>CORNER FITTING D30-D16</td> <td>1.000</td> <td>PC</td> </tr> <tr> <td>RC1042A0</td> <td>DOUBLE WIRE SPRING CLAMP D21.5-22.6</td> <td>1.000</td> <td>PC</td> </tr> <tr> <td>TB2959B0</td> <td>XEVC-1011-E VENTURI PIPE</td> <td>1.000</td> <td>PC</td> </tr> <tr> <td>VM1794A0</td> <td>250x4.8 PA66 BLACK CLAMP</td> <td>1.000</td> <td>PC</td> </tr> </tbody> </table>	Code	Description	Qty	UOM	GN1544A0	AIR INLET GASKET	2.000	PC	GN1584A0	CORNER FITTING D30-D16	1.000	PC	RC1042A0	DOUBLE WIRE SPRING CLAMP D21.5-22.6	1.000	PC	TB2959B0	XEVC-1011-E VENTURI PIPE	1.000	PC	VM1794A0	250x4.8 PA66 BLACK CLAMP	1.000	PC
					Code	Description	Qty	UOM																					
					GN1544A0	AIR INLET GASKET	2.000	PC																					
					GN1584A0	CORNER FITTING D30-D16	1.000	PC																					
			RC1042A0	DOUBLE WIRE SPRING CLAMP D21.5-22.6	1.000	PC																							
TB2959B0	XEVC-1011-E VENTURI PIPE	1.000	PC																										
VM1794A0	250x4.8 PA66 BLACK CLAMP	1.000	PC																										
KTB2958B	XEVC-0711-E VENTURI COLLECTOR PIPE KI	<table border="1"> <thead> <tr> <th>Code</th> <th>Description</th> <th>Qty</th> <th>UOM</th> </tr> </thead> <tbody> <tr> <td>GN1544A0</td> <td>AIR INLET GASKET</td> <td>1.000</td> <td>PC</td> </tr> <tr> <td>GN1584A0</td> <td>CORNER FITTING D30-D16</td> <td>1.000</td> <td>PC</td> </tr> <tr> <td>RC1042A0</td> <td>DOUBLE WIRE SPRING CLAMP D21.5-22.6</td> <td>1.000</td> <td>PC</td> </tr> <tr> <td>TB2958B0</td> <td>XEVC-0711-E VENTURI PIPE</td> <td>1.000</td> <td>PC</td> </tr> </tbody> </table>	Code	Description	Qty	UOM	GN1544A0	AIR INLET GASKET	1.000	PC	GN1584A0	CORNER FITTING D30-D16	1.000	PC	RC1042A0	DOUBLE WIRE SPRING CLAMP D21.5-22.6	1.000	PC	TB2958B0	XEVC-0711-E VENTURI PIPE	1.000	PC							
		Code	Description	Qty	UOM																								
		GN1544A0	AIR INLET GASKET	1.000	PC																								
		GN1584A0	CORNER FITTING D30-D16	1.000	PC																								
RC1042A0	DOUBLE WIRE SPRING CLAMP D21.5-22.6	1.000	PC																										
TB2958B0	XEVC-0711-E VENTURI PIPE	1.000	PC																										
KTB2957B	0511/04EU-E VENTURI COLLECTOR PIPE KI	<table border="1"> <thead> <tr> <th>Code</th> <th>Description</th> <th>Qty</th> <th>UOM</th> </tr> </thead> <tbody> <tr> <td>GN1544A0</td> <td>AIR INLET GASKET</td> <td>1.000</td> <td>PC</td> </tr> <tr> <td>GN1584A0</td> <td>CORNER FITTING D30-D16</td> <td>1.000</td> <td>PC</td> </tr> <tr> <td>RC1042A0</td> <td>DOUBLE WIRE SPRING CLAMP D21.5-22.6</td> <td>1.000</td> <td>PC</td> </tr> </tbody> </table>	Code	Description	Qty	UOM	GN1544A0	AIR INLET GASKET	1.000	PC	GN1584A0	CORNER FITTING D30-D16	1.000	PC	RC1042A0	DOUBLE WIRE SPRING CLAMP D21.5-22.6	1.000	PC											
		Code	Description	Qty	UOM																								
		GN1544A0	AIR INLET GASKET	1.000	PC																								
		GN1584A0	CORNER FITTING D30-D16	1.000	PC																								
RC1042A0	DOUBLE WIRE SPRING CLAMP D21.5-22.6	1.000	PC																										



COMPONENT			SPARE PART																										
Code	Description	Image	Code	Description	Kit components																								
GN1544A	AIR INLET GASKET		KTB2957B	0511/04EU-E VENTURI COLLECTOR PIPE KI	<table border="1"> <thead> <tr> <th>Code</th> <th>Description</th> <th>Qty</th> <th>UOM</th> </tr> </thead> <tbody> <tr> <td>TB2957B0</td> <td>XEVC-0511-E VENTURI PIPE</td> <td>1.000</td> <td>PC</td> </tr> <tr> <td>VM1794A0</td> <td>250x4.8 PA66 BLACK CLAMP</td> <td>1.000</td> <td>PC</td> </tr> </tbody> </table>	Code	Description	Qty	UOM	TB2957B0	XEVC-0511-E VENTURI PIPE	1.000	PC	VM1794A0	250x4.8 PA66 BLACK CLAMP	1.000	PC												
					Code	Description	Qty	UOM																					
					TB2957B0	XEVC-0511-E VENTURI PIPE	1.000	PC																					
					VM1794A0	250x4.8 PA66 BLACK CLAMP	1.000	PC																					
			KTB2956A	XEVC-0311-E VENTURI COLLECTOR PIPE KI	<table border="1"> <thead> <tr> <th>Code</th> <th>Description</th> <th>Qty</th> <th>UOM</th> </tr> </thead> <tbody> <tr> <td>GN1544A0</td> <td>AIR INLET GASKET</td> <td>1.000</td> <td>PC</td> </tr> <tr> <td>RC1042A0</td> <td>DOUBLE WIRE SPRING CLAMP D21.5-22.6</td> <td>1.000</td> <td>PC</td> </tr> </tbody> </table>	Code	Description	Qty	UOM	GN1544A0	AIR INLET GASKET	1.000	PC	RC1042A0	DOUBLE WIRE SPRING CLAMP D21.5-22.6	1.000	PC												
					Code	Description	Qty	UOM																					
					GN1544A0	AIR INLET GASKET	1.000	PC																					
			RC1042A0	DOUBLE WIRE SPRING CLAMP D21.5-22.6	1.000	PC																							
			TB2956A0	XEVC-0311-E VENTURI PIPE	1.000	PC																							
			KTB2944A	20XX/16XX LOWER VENTURI COLLECT PIPE KIT	<table border="1"> <thead> <tr> <th>Code</th> <th>Description</th> <th>Qty</th> <th>UOM</th> </tr> </thead> <tbody> <tr> <td>GN1544A0</td> <td>AIR INLET GASKET</td> <td>2.000</td> <td>PC</td> </tr> <tr> <td>GN1584A0</td> <td>CORNER FITTING D30-D16</td> <td>1.000</td> <td>PC</td> </tr> <tr> <td>RC1042A0</td> <td>DOUBLE WIRE SPRING CLAMP D21.5-22.6</td> <td>1.000</td> <td>PC</td> </tr> <tr> <td>TB2944A1</td> <td>XEVC-2011 AIR INLET PIPE D3</td> <td>1.000</td> <td>PC</td> </tr> <tr> <td>VM1794A0</td> <td>250x4.8 PA66 BLACK CLAMP</td> <td>1.000</td> <td>PC</td> </tr> </tbody> </table>	Code	Description	Qty	UOM	GN1544A0	AIR INLET GASKET	2.000	PC	GN1584A0	CORNER FITTING D30-D16	1.000	PC	RC1042A0	DOUBLE WIRE SPRING CLAMP D21.5-22.6	1.000	PC	TB2944A1	XEVC-2011 AIR INLET PIPE D3	1.000	PC	VM1794A0	250x4.8 PA66 BLACK CLAMP	1.000	PC
					Code	Description	Qty	UOM																					
					GN1544A0	AIR INLET GASKET	2.000	PC																					
GN1584A0	CORNER FITTING D30-D16	1.000			PC																								
RC1042A0	DOUBLE WIRE SPRING CLAMP D21.5-22.6	1.000			PC																								
TB2944A1	XEVC-2011 AIR INLET PIPE D3	1.000			PC																								
VM1794A0	250x4.8 PA66 BLACK CLAMP	1.000	PC																										
KTB1323A	XECC-05XX-E VENTURI COLLECTOR PIPE KI	<table border="1"> <thead> <tr> <th>Code</th> <th>Description</th> <th>Qty</th> <th>UOM</th> </tr> </thead> <tbody> <tr> <td>GN1544A0</td> <td>AIR INLET GASKET</td> <td>1.000</td> <td>PC</td> </tr> <tr> <td>GN1584A0</td> <td>CORNER FITTING D30-D16</td> <td>1.000</td> <td>PC</td> </tr> <tr> <td>RC1042A0</td> <td>DOUBLE WIRE SPRING CLAMP D21.5-22.6</td> <td>1.000</td> <td>PC</td> </tr> </tbody> </table>	Code	Description	Qty	UOM	GN1544A0	AIR INLET GASKET	1.000	PC	GN1584A0	CORNER FITTING D30-D16	1.000	PC	RC1042A0	DOUBLE WIRE SPRING CLAMP D21.5-22.6	1.000	PC											
		Code	Description	Qty	UOM																								
		GN1544A0	AIR INLET GASKET	1.000	PC																								
		GN1584A0	CORNER FITTING D30-D16	1.000	PC																								
RC1042A0	DOUBLE WIRE SPRING CLAMP D21.5-22.6	1.000	PC																										
TB1323A1	XECC-05xx VENTURI AIR EXIT PIPE	1.000	PC																										
KGN1544A	5 PCS AIR INLET GASKET KIT	<table border="1"> <thead> <tr> <th>Code</th> <th>Description</th> <th>Qty</th> <th>UOM</th> </tr> </thead> <tbody> <tr> <td>GN1544A0</td> <td>AIR INLET GASKET</td> <td>5.000</td> <td>PC</td> </tr> </tbody> </table>	Code	Description	Qty	UOM	GN1544A0	AIR INLET GASKET	5.000	PC																			
		Code	Description	Qty	UOM																								
GN1544A0	AIR INLET GASKET	5.000	PC																										

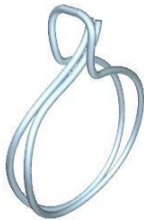

COMPONENT			SPARE PART																																																										
Code	Description	Image	Code	Description	Kit components																																																								
GN1584A	CORNER FITTING D30-D16		KGN1584A	D30-D16 CORNER FITTING KIT	<table border="1"> <thead> <tr> <th>Code</th> <th>Description</th> <th>Qty</th> <th>UOM</th> </tr> </thead> <tbody> <tr> <td>GN1584A0</td> <td>CORNER FITTING D30-D16</td> <td>1.000</td> <td>PC</td> </tr> </tbody> </table>	Code	Description	Qty	UOM	GN1584A0	CORNER FITTING D30-D16	1.000	PC																																																
Code	Description	Qty	UOM																																																										
GN1584A0	CORNER FITTING D30-D16	1.000	PC																																																										
RC1042A	DOUBLE WIRE SPRING CLAMP D21.5-22.6		<p>KTB3074B</p> <p>KTB3068B</p> <p>KTB3019A</p>	<p>XEVC-0711-G VENTURI COLLECTOR PIPE KI</p> <p>10FS/EU/2-G VENTURI COLLECTOR PIPE KI</p> <p>20XX/16XX UPPER VENTURI COLLECT PIPE KIT</p>	<table border="1"> <thead> <tr> <th>Code</th> <th>Description</th> <th>Qty</th> <th>UOM</th> </tr> </thead> <tbody> <tr> <td>GN1544A0</td> <td>AIR INLET GASKET</td> <td>1.000</td> <td>PC</td> </tr> <tr> <td>GN1584A0</td> <td>CORNER FITTING D30-D16</td> <td>1.000</td> <td>PC</td> </tr> <tr> <td>RC1042A0</td> <td>DOUBLE WIRE SPRING CLAMP D21.5-22.6</td> <td>1.000</td> <td>PC</td> </tr> <tr> <td>TB3074B0</td> <td>XEVC-07EU-G VENTURI COLLECTOR PIPE D30</td> <td>1.000</td> <td>PC</td> </tr> <tr> <td>VM1794A0</td> <td>250x4.8 PA66 BLACK CLAMP</td> <td>1.000</td> <td>PC</td> </tr> <tr> <td>GN1544A0</td> <td>AIR INLET GASKET</td> <td>2.000</td> <td>PC</td> </tr> <tr> <td>GN1584A0</td> <td>CORNER FITTING D30-D16</td> <td>1.000</td> <td>PC</td> </tr> <tr> <td>RC1042A0</td> <td>DOUBLE WIRE SPRING CLAMP D21.5-22.6</td> <td>1.000</td> <td>PC</td> </tr> <tr> <td>TB3068B0</td> <td>XEBC-10 VENTURI AIR COLLECTOR PIPE D30</td> <td>1.000</td> <td>PC</td> </tr> <tr> <td>VM1794A0</td> <td>250x4.8 PA66 BLACK CLAMP</td> <td>1.000</td> <td>PC</td> </tr> <tr> <td>GN1544A0</td> <td>AIR INLET GASKET</td> <td>1.000</td> <td>PC</td> </tr> <tr> <td>GN1584A0</td> <td>CORNER FITTING D30-D16</td> <td>1.000</td> <td>PC</td> </tr> <tr> <td>RC1042A0</td> <td>DOUBLE WIRE SPRING CLAMP D21.5-22.6</td> <td>1.000</td> <td>PC</td> </tr> </tbody> </table>	Code	Description	Qty	UOM	GN1544A0	AIR INLET GASKET	1.000	PC	GN1584A0	CORNER FITTING D30-D16	1.000	PC	RC1042A0	DOUBLE WIRE SPRING CLAMP D21.5-22.6	1.000	PC	TB3074B0	XEVC-07EU-G VENTURI COLLECTOR PIPE D30	1.000	PC	VM1794A0	250x4.8 PA66 BLACK CLAMP	1.000	PC	GN1544A0	AIR INLET GASKET	2.000	PC	GN1584A0	CORNER FITTING D30-D16	1.000	PC	RC1042A0	DOUBLE WIRE SPRING CLAMP D21.5-22.6	1.000	PC	TB3068B0	XEBC-10 VENTURI AIR COLLECTOR PIPE D30	1.000	PC	VM1794A0	250x4.8 PA66 BLACK CLAMP	1.000	PC	GN1544A0	AIR INLET GASKET	1.000	PC	GN1584A0	CORNER FITTING D30-D16	1.000	PC	RC1042A0	DOUBLE WIRE SPRING CLAMP D21.5-22.6	1.000	PC
Code	Description	Qty	UOM																																																										
GN1544A0	AIR INLET GASKET	1.000	PC																																																										
GN1584A0	CORNER FITTING D30-D16	1.000	PC																																																										
RC1042A0	DOUBLE WIRE SPRING CLAMP D21.5-22.6	1.000	PC																																																										
TB3074B0	XEVC-07EU-G VENTURI COLLECTOR PIPE D30	1.000	PC																																																										
VM1794A0	250x4.8 PA66 BLACK CLAMP	1.000	PC																																																										
GN1544A0	AIR INLET GASKET	2.000	PC																																																										
GN1584A0	CORNER FITTING D30-D16	1.000	PC																																																										
RC1042A0	DOUBLE WIRE SPRING CLAMP D21.5-22.6	1.000	PC																																																										
TB3068B0	XEBC-10 VENTURI AIR COLLECTOR PIPE D30	1.000	PC																																																										
VM1794A0	250x4.8 PA66 BLACK CLAMP	1.000	PC																																																										
GN1544A0	AIR INLET GASKET	1.000	PC																																																										
GN1584A0	CORNER FITTING D30-D16	1.000	PC																																																										
RC1042A0	DOUBLE WIRE SPRING CLAMP D21.5-22.6	1.000	PC																																																										

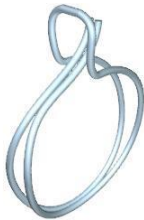

COMPONENT			SPARE PART																								
Code	Description	Image	Code	Description	Kit components																						
RC1042A	DOUBLE WIRE SPRING CLAMP D21.5-22.6		KTB3019A	20XX/16XX UPPER VENTURI COLLECT PIPE KIT	<table border="1"> <thead> <tr> <th>Code</th> <th>Description</th> <th>Qty</th> <th>UOM</th> </tr> </thead> <tbody> <tr> <td>TB3019A1</td> <td>XEVC-2011 UPPER AIR INLET PIPE D3</td> <td>1.000</td> <td>PC</td> </tr> <tr> <td>VM1794A0</td> <td>250x4.8 PA66 BLACK CLAMP</td> <td>1.000</td> <td>PC</td> </tr> </tbody> </table>	Code	Description	Qty	UOM	TB3019A1	XEVC-2011 UPPER AIR INLET PIPE D3	1.000	PC	VM1794A0	250x4.8 PA66 BLACK CLAMP	1.000	PC										
					Code	Description	Qty	UOM																			
					TB3019A1	XEVC-2011 UPPER AIR INLET PIPE D3	1.000	PC																			
			VM1794A0	250x4.8 PA66 BLACK CLAMP	1.000	PC																					
			<table border="1"> <thead> <tr> <th>Code</th> <th>Description</th> <th>Qty</th> <th>UOM</th> </tr> </thead> <tbody> <tr> <td>GN1544A0</td> <td>AIR INLET GASKET</td> <td>2.000</td> <td>PC</td> </tr> <tr> <td>GN1584A0</td> <td>CORNER FITTING D30-D16</td> <td>1.000</td> <td>PC</td> </tr> <tr> <td>RC1042A0</td> <td>DOUBLE WIRE SPRING CLAMP D21.5-22.6</td> <td>1.000</td> <td>PC</td> </tr> <tr> <td>TB2979C0</td> <td>XEBC-10 VENTURI AIR COLLECTOR PIPE D30</td> <td>1.000</td> <td>PC</td> </tr> <tr> <td>VM1794A0</td> <td>250x4.8 PA66 BLACK CLAMP</td> <td>1.000</td> <td>PC</td> </tr> </tbody> </table>	Code	Description	Qty	UOM	GN1544A0	AIR INLET GASKET	2.000	PC	GN1584A0	CORNER FITTING D30-D16	1.000	PC	RC1042A0	DOUBLE WIRE SPRING CLAMP D21.5-22.6	1.000	PC	TB2979C0	XEBC-10 VENTURI AIR COLLECTOR PIPE D30	1.000	PC	VM1794A0	250x4.8 PA66 BLACK CLAMP	1.000	PC
			Code	Description	Qty	UOM																					
			GN1544A0	AIR INLET GASKET	2.000	PC																					
			GN1584A0	CORNER FITTING D30-D16	1.000	PC																					
			RC1042A0	DOUBLE WIRE SPRING CLAMP D21.5-22.6	1.000	PC																					
			TB2979C0	XEBC-10 VENTURI AIR COLLECTOR PIPE D30	1.000	PC																					
			VM1794A0	250x4.8 PA66 BLACK CLAMP	1.000	PC																					
			<table border="1"> <thead> <tr> <th>Code</th> <th>Description</th> <th>Qty</th> <th>UOM</th> </tr> </thead> <tbody> <tr> <td>GN1544A0</td> <td>AIR INLET GASKET</td> <td>1.000</td> <td>PC</td> </tr> <tr> <td>GN1584A0</td> <td>CORNER FITTING D30-D16</td> <td>1.000</td> <td>PC</td> </tr> <tr> <td>RC1042A0</td> <td>DOUBLE WIRE SPRING CLAMP D21.5-22.6</td> <td>1.000</td> <td>PC</td> </tr> <tr> <td>TB2978B0</td> <td>XEBC-06 VENTURI AIR COLLECTOR PIPE D30</td> <td>1.000</td> <td>PC</td> </tr> <tr> <td>VM1794A0</td> <td>250x4.8 PA66 BLACK CLAMP</td> <td>1.000</td> <td>PC</td> </tr> </tbody> </table>	Code	Description	Qty	UOM	GN1544A0	AIR INLET GASKET	1.000	PC	GN1584A0	CORNER FITTING D30-D16	1.000	PC	RC1042A0	DOUBLE WIRE SPRING CLAMP D21.5-22.6	1.000	PC	TB2978B0	XEBC-06 VENTURI AIR COLLECTOR PIPE D30	1.000	PC	VM1794A0	250x4.8 PA66 BLACK CLAMP	1.000	PC
			Code	Description	Qty	UOM																					
			GN1544A0	AIR INLET GASKET	1.000	PC																					
			GN1584A0	CORNER FITTING D30-D16	1.000	PC																					
RC1042A0	DOUBLE WIRE SPRING CLAMP D21.5-22.6	1.000	PC																								
TB2978B0	XEBC-06 VENTURI AIR COLLECTOR PIPE D30	1.000	PC																								
VM1794A0	250x4.8 PA66 BLACK CLAMP	1.000	PC																								
<table border="1"> <thead> <tr> <th>Code</th> <th>Description</th> <th>Qty</th> <th>UOM</th> </tr> </thead> <tbody> <tr> <td>GN1544A0</td> <td>AIR INLET GASKET</td> <td>2.000</td> <td>PC</td> </tr> <tr> <td>GN1584A0</td> <td>CORNER FITTING D30-D16</td> <td>1.000</td> <td>PC</td> </tr> <tr> <td>RC1042A0</td> <td>DOUBLE WIRE SPRING CLAMP D21.5-22.6</td> <td>1.000</td> <td>PC</td> </tr> <tr> <td>TB2959B0</td> <td>XEVC-1011-E VENTURI PIPE</td> <td>1.000</td> <td>PC</td> </tr> <tr> <td>VM1794A0</td> <td>250x4.8 PA66 BLACK CLAMP</td> <td>1.000</td> <td>PC</td> </tr> </tbody> </table>	Code	Description	Qty	UOM	GN1544A0	AIR INLET GASKET	2.000	PC	GN1584A0	CORNER FITTING D30-D16	1.000	PC	RC1042A0	DOUBLE WIRE SPRING CLAMP D21.5-22.6	1.000	PC	TB2959B0	XEVC-1011-E VENTURI PIPE	1.000	PC	VM1794A0	250x4.8 PA66 BLACK CLAMP	1.000	PC			
Code	Description	Qty	UOM																								
GN1544A0	AIR INLET GASKET	2.000	PC																								
GN1584A0	CORNER FITTING D30-D16	1.000	PC																								
RC1042A0	DOUBLE WIRE SPRING CLAMP D21.5-22.6	1.000	PC																								
TB2959B0	XEVC-1011-E VENTURI PIPE	1.000	PC																								
VM1794A0	250x4.8 PA66 BLACK CLAMP	1.000	PC																								
KTB2979C	XEBC-10XX-E VENTURI COLLECTOR PIPE KI																										
KTB2978B	06EU/FS/21 VENTURI COLLECTOR PIPE KI																										
KTB2959B	XEVC-1011-E VENTURI COLLECTOR PIPE KI																										

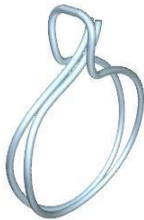

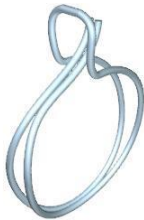
COMPONENT			SPARE PART																										
Code	Description	Image	Code	Description	Kit components																								
RC1042A	DOUBLE WIRE SPRING CLAMP D21.5-22.6		KTB2958B	XEVC-0711-E VENTURI COLLECTOR PIPE KI	<table border="1"> <thead> <tr> <th>Code</th> <th>Description</th> <th>Qty</th> <th>UOM</th> </tr> </thead> <tbody> <tr> <td>GN1544A0</td> <td>AIR INLET GASKET</td> <td>1.000</td> <td>PC</td> </tr> <tr> <td>GN1584A0</td> <td>CORNER FITTING D30-D16</td> <td>1.000</td> <td>PC</td> </tr> <tr> <td>RC1042A0</td> <td>DOUBLE WIRE SPRING CLAMP D21.5-22.6</td> <td>1.000</td> <td>PC</td> </tr> <tr> <td>TB2958B0</td> <td>XEVC-0711-E VENTURI PIPE</td> <td>1.000</td> <td>PC</td> </tr> </tbody> </table>	Code	Description	Qty	UOM	GN1544A0	AIR INLET GASKET	1.000	PC	GN1584A0	CORNER FITTING D30-D16	1.000	PC	RC1042A0	DOUBLE WIRE SPRING CLAMP D21.5-22.6	1.000	PC	TB2958B0	XEVC-0711-E VENTURI PIPE	1.000	PC				
					Code	Description	Qty	UOM																					
					GN1544A0	AIR INLET GASKET	1.000	PC																					
					GN1584A0	CORNER FITTING D30-D16	1.000	PC																					
			RC1042A0	DOUBLE WIRE SPRING CLAMP D21.5-22.6	1.000	PC																							
			TB2958B0	XEVC-0711-E VENTURI PIPE	1.000	PC																							
			KTB2957B	0511/04EU-E VENTURI COLLECTOR PIPE KI	<table border="1"> <thead> <tr> <th>Code</th> <th>Description</th> <th>Qty</th> <th>UOM</th> </tr> </thead> <tbody> <tr> <td>GN1544A0</td> <td>AIR INLET GASKET</td> <td>1.000</td> <td>PC</td> </tr> <tr> <td>GN1584A0</td> <td>CORNER FITTING D30-D16</td> <td>1.000</td> <td>PC</td> </tr> <tr> <td>RC1042A0</td> <td>DOUBLE WIRE SPRING CLAMP D21.5-22.6</td> <td>1.000</td> <td>PC</td> </tr> <tr> <td>TB2957B0</td> <td>XEVC-0511-E VENTURI PIPE</td> <td>1.000</td> <td>PC</td> </tr> <tr> <td>VM1794A0</td> <td>250x4.8 PA66 BLACK CLAMP</td> <td>1.000</td> <td>PC</td> </tr> </tbody> </table>	Code	Description	Qty	UOM	GN1544A0	AIR INLET GASKET	1.000	PC	GN1584A0	CORNER FITTING D30-D16	1.000	PC	RC1042A0	DOUBLE WIRE SPRING CLAMP D21.5-22.6	1.000	PC	TB2957B0	XEVC-0511-E VENTURI PIPE	1.000	PC	VM1794A0	250x4.8 PA66 BLACK CLAMP	1.000	PC
					Code	Description	Qty	UOM																					
					GN1544A0	AIR INLET GASKET	1.000	PC																					
					GN1584A0	CORNER FITTING D30-D16	1.000	PC																					
			RC1042A0	DOUBLE WIRE SPRING CLAMP D21.5-22.6	1.000	PC																							
			TB2957B0	XEVC-0511-E VENTURI PIPE	1.000	PC																							
			VM1794A0	250x4.8 PA66 BLACK CLAMP	1.000	PC																							
			KTB2956A	XEVC-0311-E VENTURI COLLECTOR PIPE KI	<table border="1"> <thead> <tr> <th>Code</th> <th>Description</th> <th>Qty</th> <th>UOM</th> </tr> </thead> <tbody> <tr> <td>GN1544A0</td> <td>AIR INLET GASKET</td> <td>1.000</td> <td>PC</td> </tr> <tr> <td>RC1042A0</td> <td>DOUBLE WIRE SPRING CLAMP D21.5-22.6</td> <td>1.000</td> <td>PC</td> </tr> <tr> <td>TB2956A0</td> <td>XEVC-0311-E VENTURI PIPE</td> <td>1.000</td> <td>PC</td> </tr> </tbody> </table>	Code	Description	Qty	UOM	GN1544A0	AIR INLET GASKET	1.000	PC	RC1042A0	DOUBLE WIRE SPRING CLAMP D21.5-22.6	1.000	PC	TB2956A0	XEVC-0311-E VENTURI PIPE	1.000	PC								
					Code	Description	Qty	UOM																					
					GN1544A0	AIR INLET GASKET	1.000	PC																					
RC1042A0	DOUBLE WIRE SPRING CLAMP D21.5-22.6	1.000	PC																										
TB2956A0	XEVC-0311-E VENTURI PIPE	1.000	PC																										
KTB2944A	20XX/16XX LOWER VENTURI COLLECT PIPE KIT	<table border="1"> <thead> <tr> <th>Code</th> <th>Description</th> <th>Qty</th> <th>UOM</th> </tr> </thead> <tbody> <tr> <td>GN1544A0</td> <td>AIR INLET GASKET</td> <td>2.000</td> <td>PC</td> </tr> <tr> <td>GN1584A0</td> <td>CORNER FITTING D30-D16</td> <td>1.000</td> <td>PC</td> </tr> <tr> <td>RC1042A0</td> <td>DOUBLE WIRE SPRING CLAMP D21.5-22.6</td> <td>1.000</td> <td>PC</td> </tr> <tr> <td>TB2944A1</td> <td>XEVC-2011 AIR INLET PIPE D3</td> <td>1.000</td> <td>PC</td> </tr> <tr> <td>VM1794A0</td> <td>250x4.8 PA66 BLACK CLAMP</td> <td>1.000</td> <td>PC</td> </tr> </tbody> </table>	Code	Description	Qty	UOM	GN1544A0	AIR INLET GASKET	2.000	PC	GN1584A0	CORNER FITTING D30-D16	1.000	PC	RC1042A0	DOUBLE WIRE SPRING CLAMP D21.5-22.6	1.000	PC	TB2944A1	XEVC-2011 AIR INLET PIPE D3	1.000	PC	VM1794A0	250x4.8 PA66 BLACK CLAMP	1.000	PC			
		Code	Description	Qty	UOM																								
		GN1544A0	AIR INLET GASKET	2.000	PC																								
		GN1584A0	CORNER FITTING D30-D16	1.000	PC																								
		RC1042A0	DOUBLE WIRE SPRING CLAMP D21.5-22.6	1.000	PC																								
TB2944A1	XEVC-2011 AIR INLET PIPE D3	1.000	PC																										
VM1794A0	250x4.8 PA66 BLACK CLAMP	1.000	PC																										

COMPONENT			SPARE PART																																																																										
Code	Description	Image	Code	Description	Kit components																																																																								
RC1042A	DOUBLE WIRE SPRING CLAMP D21.5-22.6		KRC1042A	10PCS CLAMP BIFIL SPRING D21.5-22.6 KIT	<table border="1"> <thead> <tr> <th>Code</th> <th>Description</th> <th>Qty</th> <th>UOM</th> </tr> </thead> <tbody> <tr> <td>RC1042A0</td> <td>DOUBLE WIRE SPRING CLAMP D21.5-22.6</td> <td>10.000</td> <td>PC</td> </tr> </tbody> </table>	Code	Description	Qty	UOM	RC1042A0	DOUBLE WIRE SPRING CLAMP D21.5-22.6	10.000	PC																																																																
Code	Description	Qty	UOM																																																																										
RC1042A0	DOUBLE WIRE SPRING CLAMP D21.5-22.6	10.000	PC																																																																										
RC1378A	HOSE CLAMP		<p>KVM2379A</p> <p>KVM2378A</p> <p>KVM2377A</p> <p>KVE1140A</p> <p>KVE1014A</p> <p>KRC1378A</p>	<p>MM 200V VENTURI ACTUATOR SYSTEM KIT</p> <p>MM 240V VENTURI ACTUATOR SYSTEM KIT</p> <p>MM 220 V VENTURI ACTUATOR SYSTEM KIT</p> <p>S.5/5E JAPAN VERSION VENTURI COIL KIT</p> <p>US VERSION SERIES 5 VENTURI COIL KIT</p> <p>HOSE CLAMP 10 PCS KIT</p>	<table border="1"> <thead> <tr> <th>Code</th> <th>Description</th> <th>Qty</th> <th>UOM</th> </tr> </thead> <tbody> <tr> <td>RC1378A0</td> <td>HOSE CLAMP</td> <td>3.000</td> <td>PC</td> </tr> <tr> <td>TB1520A0</td> <td>Int. Ø=38 TH=4 DRAIN BLACK RUBBER PIPE</td> <td>0.120</td> <td>M</td> </tr> <tr> <td>VM2379A1</td> <td></td> <td>1.000</td> <td>PC</td> </tr> <tr> <td>RC1378A0</td> <td>HOSE CLAMP</td> <td>3.000</td> <td>PC</td> </tr> <tr> <td>TB1520A0</td> <td>Int. Ø=38 TH=4 DRAIN BLACK RUBBER PIPE</td> <td>0.120</td> <td>M</td> </tr> <tr> <td>VM2378A1</td> <td></td> <td>1.000</td> <td>PC</td> </tr> <tr> <td>RC1378A0</td> <td>HOSE CLAMP</td> <td>3.000</td> <td>PC</td> </tr> <tr> <td>TB1520A0</td> <td>Int. Ø=38 TH=4 DRAIN BLACK RUBBER PIPE</td> <td>0.120</td> <td>M</td> </tr> <tr> <td>VM2377A1</td> <td>220 V 50/60 HZ EUR VENTURI SET</td> <td>1.000</td> <td>PC</td> </tr> <tr> <td>RC1378A0</td> <td>HOSE CLAMP</td> <td>2.000</td> <td>PC</td> </tr> <tr> <td>TB1520A0</td> <td>Int. Ø=38 TH=4 DRAIN BLACK RUBBER PIPE</td> <td>0.050</td> <td>M</td> </tr> <tr> <td>VI1220A1</td> <td>4,2x12 TCB SELF-TAPPIN G SCREW</td> <td>1.000</td> <td>PC</td> </tr> <tr> <td>VM2632A0</td> <td></td> <td>1.000</td> <td>PC</td> </tr> <tr> <td>RC1378A0</td> <td>HOSE CLAMP</td> <td>2.000</td> <td>PC</td> </tr> <tr> <td>TB1520A0</td> <td>Int. Ø=38 TH=4 DRAIN BLACK RUBBER PIPE</td> <td>0.050</td> <td>M</td> </tr> <tr> <td>VM2633A0</td> <td></td> <td>1.000</td> <td>PC</td> </tr> <tr> <td>RC1378A0</td> <td>HOSE CLAMP</td> <td>10.000</td> <td>PC</td> </tr> </tbody> </table>	Code	Description	Qty	UOM	RC1378A0	HOSE CLAMP	3.000	PC	TB1520A0	Int. Ø=38 TH=4 DRAIN BLACK RUBBER PIPE	0.120	M	VM2379A1		1.000	PC	RC1378A0	HOSE CLAMP	3.000	PC	TB1520A0	Int. Ø=38 TH=4 DRAIN BLACK RUBBER PIPE	0.120	M	VM2378A1		1.000	PC	RC1378A0	HOSE CLAMP	3.000	PC	TB1520A0	Int. Ø=38 TH=4 DRAIN BLACK RUBBER PIPE	0.120	M	VM2377A1	220 V 50/60 HZ EUR VENTURI SET	1.000	PC	RC1378A0	HOSE CLAMP	2.000	PC	TB1520A0	Int. Ø=38 TH=4 DRAIN BLACK RUBBER PIPE	0.050	M	VI1220A1	4,2x12 TCB SELF-TAPPIN G SCREW	1.000	PC	VM2632A0		1.000	PC	RC1378A0	HOSE CLAMP	2.000	PC	TB1520A0	Int. Ø=38 TH=4 DRAIN BLACK RUBBER PIPE	0.050	M	VM2633A0		1.000	PC	RC1378A0	HOSE CLAMP	10.000	PC
Code	Description	Qty	UOM																																																																										
RC1378A0	HOSE CLAMP	3.000	PC																																																																										
TB1520A0	Int. Ø=38 TH=4 DRAIN BLACK RUBBER PIPE	0.120	M																																																																										
VM2379A1		1.000	PC																																																																										
RC1378A0	HOSE CLAMP	3.000	PC																																																																										
TB1520A0	Int. Ø=38 TH=4 DRAIN BLACK RUBBER PIPE	0.120	M																																																																										
VM2378A1		1.000	PC																																																																										
RC1378A0	HOSE CLAMP	3.000	PC																																																																										
TB1520A0	Int. Ø=38 TH=4 DRAIN BLACK RUBBER PIPE	0.120	M																																																																										
VM2377A1	220 V 50/60 HZ EUR VENTURI SET	1.000	PC																																																																										
RC1378A0	HOSE CLAMP	2.000	PC																																																																										
TB1520A0	Int. Ø=38 TH=4 DRAIN BLACK RUBBER PIPE	0.050	M																																																																										
VI1220A1	4,2x12 TCB SELF-TAPPIN G SCREW	1.000	PC																																																																										
VM2632A0		1.000	PC																																																																										
RC1378A0	HOSE CLAMP	2.000	PC																																																																										
TB1520A0	Int. Ø=38 TH=4 DRAIN BLACK RUBBER PIPE	0.050	M																																																																										
VM2633A0		1.000	PC																																																																										
RC1378A0	HOSE CLAMP	10.000	PC																																																																										

COMPONENT			SPARE PART																															
Code	Description	Image	Code	Description	Kit components																													
TB1956A	TB1520A-GREY SILICONE PIPE L=0,04M		KTB1002A	BLACK TUBE KIT EPDM 240MT TB1520A	<table border="1"> <thead> <tr> <th>Code</th> <th>Description</th> <th>Qty</th> <th>UOM</th> </tr> </thead> <tbody> <tr> <td>TB1520A0</td> <td>Int. Ø=38 TH=4</td> <td>240.000</td> <td>M</td> </tr> <tr> <td></td> <td>DRAIN BLACK</td> <td></td> <td></td> </tr> <tr> <td></td> <td>RUBBER PIPE</td> <td></td> <td></td> </tr> </tbody> </table>	Code	Description	Qty	UOM	TB1520A0	Int. Ø=38 TH=4	240.000	M		DRAIN BLACK				RUBBER PIPE															
			Code	Description	Qty	UOM																												
			TB1520A0	Int. Ø=38 TH=4	240.000	M																												
	DRAIN BLACK																																	
	RUBBER PIPE																																	
KTB1001A	BLACK TUBE KIT EPDM 10MT TB1520	<table border="1"> <thead> <tr> <th>Code</th> <th>Description</th> <th>Qty</th> <th>UOM</th> </tr> </thead> <tbody> <tr> <td>TB1520A0</td> <td>Int. Ø=38 TH=4</td> <td>10.000</td> <td>M</td> </tr> <tr> <td></td> <td>DRAIN BLACK</td> <td></td> <td></td> </tr> <tr> <td></td> <td>RUBBER PIPE</td> <td></td> <td></td> </tr> <tr> <td>VM1794A0</td> <td>250x4.8 PA66</td> <td>3.000</td> <td>PC</td> </tr> <tr> <td></td> <td>BLACK CLAMP</td> <td></td> <td></td> </tr> </tbody> </table>	Code	Description	Qty	UOM	TB1520A0	Int. Ø=38 TH=4	10.000	M		DRAIN BLACK				RUBBER PIPE			VM1794A0	250x4.8 PA66	3.000	PC		BLACK CLAMP										
Code	Description	Qty	UOM																															
TB1520A0	Int. Ø=38 TH=4	10.000	M																															
	DRAIN BLACK																																	
	RUBBER PIPE																																	
VM1794A0	250x4.8 PA66	3.000	PC																															
	BLACK CLAMP																																	
KTB1000A	EPDM BLACK TUBE TB1520A 2MT KIT	<table border="1"> <thead> <tr> <th>Code</th> <th>Description</th> <th>Qty</th> <th>UOM</th> </tr> </thead> <tbody> <tr> <td>RC1055A0</td> <td>Ø25-40 H12</td> <td>2.000</td> <td>PC</td> </tr> <tr> <td></td> <td>STAINLESS</td> <td></td> <td></td> </tr> <tr> <td></td> <td>STEEL PIPE</td> <td></td> <td></td> </tr> <tr> <td></td> <td>CLIP</td> <td></td> <td></td> </tr> <tr> <td>TB1520A0</td> <td>Int. Ø=38 TH=4</td> <td>2.000</td> <td>M</td> </tr> <tr> <td></td> <td>DRAIN BLACK</td> <td></td> <td></td> </tr> <tr> <td></td> <td>RUBBER PIPE</td> <td></td> <td></td> </tr> </tbody> </table>	Code	Description	Qty	UOM	RC1055A0	Ø25-40 H12	2.000	PC		STAINLESS				STEEL PIPE				CLIP			TB1520A0	Int. Ø=38 TH=4	2.000	M		DRAIN BLACK				RUBBER PIPE		
Code	Description	Qty	UOM																															
RC1055A0	Ø25-40 H12	2.000	PC																															
	STAINLESS																																	
	STEEL PIPE																																	
	CLIP																																	
TB1520A0	Int. Ø=38 TH=4	2.000	M																															
	DRAIN BLACK																																	
	RUBBER PIPE																																	
TB2603A	TB1520A0- VENTURI FAN 0,12M		KTB2603A	VENTURI-COOLING FAN CONNECT. KIT TB1520A	<table border="1"> <thead> <tr> <th>Code</th> <th>Description</th> <th>Qty</th> <th>UOM</th> </tr> </thead> <tbody> <tr> <td>TB1520A0</td> <td>Int. Ø=38 TH=4</td> <td>0.120</td> <td>M</td> </tr> <tr> <td></td> <td>DRAIN BLACK</td> <td></td> <td></td> </tr> <tr> <td></td> <td>RUBBER PIPE</td> <td></td> <td></td> </tr> </tbody> </table>	Code	Description	Qty	UOM	TB1520A0	Int. Ø=38 TH=4	0.120	M		DRAIN BLACK				RUBBER PIPE															
Code	Description	Qty	UOM																															
TB1520A0	Int. Ø=38 TH=4	0.120	M																															
	DRAIN BLACK																																	
	RUBBER PIPE																																	
TB3187A	XEVC-1011-G VENTURI COLLECTOR PIPE D30		OUTOFPRODUCTIO	ITEM OUT OF PRODUCTION																														
VM2377A	220 V 50/60 HZ EUR VENTURI SET		KVM2377A	MM 220 V VENTURI ACTUATOR SYSTEM KIT	<table border="1"> <thead> <tr> <th>Code</th> <th>Description</th> <th>Qty</th> <th>UOM</th> </tr> </thead> <tbody> <tr> <td>RC1378A0</td> <td>HOSE CLAMP</td> <td>3.000</td> <td>PC</td> </tr> <tr> <td>TB1520A0</td> <td>Int. Ø=38 TH=4</td> <td>0.120</td> <td>M</td> </tr> <tr> <td></td> <td>DRAIN BLACK</td> <td></td> <td></td> </tr> <tr> <td></td> <td>RUBBER PIPE</td> <td></td> <td></td> </tr> <tr> <td>VM2377A1</td> <td>220 V 50/60 HZ EUR VENTURI SET</td> <td>1.000</td> <td>PC</td> </tr> </tbody> </table>	Code	Description	Qty	UOM	RC1378A0	HOSE CLAMP	3.000	PC	TB1520A0	Int. Ø=38 TH=4	0.120	M		DRAIN BLACK				RUBBER PIPE			VM2377A1	220 V 50/60 HZ EUR VENTURI SET	1.000	PC					
			Code	Description	Qty	UOM																												
			RC1378A0	HOSE CLAMP	3.000	PC																												
TB1520A0	Int. Ø=38 TH=4	0.120	M																															
	DRAIN BLACK																																	
	RUBBER PIPE																																	
VM2377A1	220 V 50/60 HZ EUR VENTURI SET	1.000	PC																															





COMPONENT			SPARE PART																																		
Code	Description	Image	Code	Description	Kit components																																
0G1726A	XEVC-1011-G FAN GUARD W/FINS		K0G1726A	XEVC-1011-G COMPLETE FAN GUARD KIT	<table border="1"> <thead> <tr> <th>Code</th> <th>Description</th> <th>Qty</th> <th>UOM</th> </tr> </thead> <tbody> <tr> <td>0G1726A1</td> <td>XEVC-1011-G FAN GUARD W/FINS</td> <td>1.000</td> <td>PC</td> </tr> <tr> <td>TB4412A0</td> <td>TB4412A0</td> <td>1.000</td> <td>PC</td> </tr> <tr> <td>TB4413A0</td> <td>TB4413A0</td> <td>1.000</td> <td>PC</td> </tr> <tr> <td>VI1220A1</td> <td>4,2x12 TCB SELF-TAPPIN G SCREW</td> <td>4.000</td> <td>PC</td> </tr> <tr> <td>VM2332A2</td> <td>STEAM WATER PIPES BUSHING</td> <td>1.000</td> <td>PC</td> </tr> <tr> <td>VP1378A0</td> <td>PEEK UPPER WATER DISTRIBUTOR</td> <td>1.000</td> <td>PC</td> </tr> <tr> <td>VP1379A0</td> <td>PEEK LOWER WATER DISTRIBUTOR</td> <td>1.000</td> <td>PC</td> </tr> </tbody> </table>	Code	Description	Qty	UOM	0G1726A1	XEVC-1011-G FAN GUARD W/FINS	1.000	PC	TB4412A0	TB4412A0	1.000	PC	TB4413A0	TB4413A0	1.000	PC	VI1220A1	4,2x12 TCB SELF-TAPPIN G SCREW	4.000	PC	VM2332A2	STEAM WATER PIPES BUSHING	1.000	PC	VP1378A0	PEEK UPPER WATER DISTRIBUTOR	1.000	PC	VP1379A0	PEEK LOWER WATER DISTRIBUTOR	1.000	PC
					Code	Description	Qty	UOM																													
0G1726A1	XEVC-1011-G FAN GUARD W/FINS	1.000	PC																																		
TB4412A0	TB4412A0	1.000	PC																																		
TB4413A0	TB4413A0	1.000	PC																																		
VI1220A1	4,2x12 TCB SELF-TAPPIN G SCREW	4.000	PC																																		
VM2332A2	STEAM WATER PIPES BUSHING	1.000	PC																																		
VP1378A0	PEEK UPPER WATER DISTRIBUTOR	1.000	PC																																		
VP1379A0	PEEK LOWER WATER DISTRIBUTOR	1.000	PC																																		
VP1378A	PEEK UPPER WATER DISTRIBUTOR		KVP1378A	STEAM PIPE UPPER+LOWER DISTRIBUTORS KIT	<table border="1"> <thead> <tr> <th>Code</th> <th>Description</th> <th>Qty</th> <th>UOM</th> </tr> </thead> <tbody> <tr> <td>VP1378A0</td> <td>PEEK UPPER WATER DISTRIBUTOR</td> <td>1.000</td> <td>PC</td> </tr> <tr> <td>VP1379A0</td> <td>PEEK LOWER WATER DISTRIBUTOR</td> <td>1.000</td> <td>PC</td> </tr> </tbody> </table>	Code	Description	Qty	UOM	VP1378A0	PEEK UPPER WATER DISTRIBUTOR	1.000	PC	VP1379A0	PEEK LOWER WATER DISTRIBUTOR	1.000	PC																				
Code	Description	Qty	UOM																																		
VP1378A0	PEEK UPPER WATER DISTRIBUTOR	1.000	PC																																		
VP1379A0	PEEK LOWER WATER DISTRIBUTOR	1.000	PC																																		
VP1379A	PEEK LOWER WATER DISTRIBUTOR		KVP1378A	STEAM PIPE UPPER+LOWER DISTRIBUTORS KIT	<table border="1"> <thead> <tr> <th>Code</th> <th>Description</th> <th>Qty</th> <th>UOM</th> </tr> </thead> <tbody> <tr> <td>VP1378A0</td> <td>PEEK UPPER WATER DISTRIBUTOR</td> <td>1.000</td> <td>PC</td> </tr> <tr> <td>VP1379A0</td> <td>PEEK LOWER WATER DISTRIBUTOR</td> <td>1.000</td> <td>PC</td> </tr> </tbody> </table>	Code	Description	Qty	UOM	VP1378A0	PEEK UPPER WATER DISTRIBUTOR	1.000	PC	VP1379A0	PEEK LOWER WATER DISTRIBUTOR	1.000	PC																				
Code	Description	Qty	UOM																																		
VP1378A0	PEEK UPPER WATER DISTRIBUTOR	1.000	PC																																		
VP1379A0	PEEK LOWER WATER DISTRIBUTOR	1.000	PC																																		
TB4412A	TB4412A0		TB4412A0	TB4412A0																																	



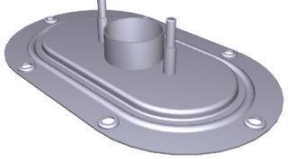

COMPONENT			SPARE PART																														
Code	Description	Image	Code	Description	Kit components																												
TB4413A	TB4413A0		TB4413A0	TB4413A0																													
VM2332A	STEAM WATER PIPES BUSHING		KVM2332A	WATER PIPE BUSHING KIT VM2332A0	<table border="1"> <thead> <tr> <th>Code</th> <th>Description</th> <th>Qty</th> <th>UOM</th> </tr> </thead> <tbody> <tr> <td>VM2332A2</td> <td>STEAM WATER PIPES BUSHING</td> <td>1.000</td> <td>PC</td> </tr> </tbody> </table>	Code	Description	Qty	UOM	VM2332A2	STEAM WATER PIPES BUSHING	1.000	PC																				
Code	Description	Qty	UOM																														
VM2332A2	STEAM WATER PIPES BUSHING	1.000	PC																														
ASM4290A	General overview		ASM4290A0	General overview																													
ON1428A	CHIMNEY HOLDING DISC 30		KON1459A	D30 CHIMNEY FLANGE KIT	<table border="1"> <thead> <tr> <th>Code</th> <th>Description</th> <th>Qty</th> <th>UOM</th> </tr> </thead> <tbody> <tr> <td>ON1428A0</td> <td>CHIMNEY HOLDING DISC 30</td> <td>2.000</td> <td>PC</td> </tr> <tr> <td>ON1459A0</td> <td>FLANGE SEALING CHIMNEY 30 HEAT EXCHANGER</td> <td>1.000</td> <td>PC</td> </tr> <tr> <td>ON1469A0</td> <td>CHIMNEY SEALING PLATE 30</td> <td>1.000</td> <td>PC</td> </tr> <tr> <td>SL1045A0</td> <td>S57 BLACK SILICONE - 80ml CARTRIDGE</td> <td>1.000</td> <td>PC</td> </tr> <tr> <td>VI1555A0</td> <td>Ø6 ST. STEEL SCHNOOR KNURLED WASHER</td> <td>8.000</td> <td>PC</td> </tr> <tr> <td>VI2018A0</td> <td>M6x1 H6 CH10 BRASS NUT</td> <td>16.000</td> <td>PC</td> </tr> </tbody> </table>	Code	Description	Qty	UOM	ON1428A0	CHIMNEY HOLDING DISC 30	2.000	PC	ON1459A0	FLANGE SEALING CHIMNEY 30 HEAT EXCHANGER	1.000	PC	ON1469A0	CHIMNEY SEALING PLATE 30	1.000	PC	SL1045A0	S57 BLACK SILICONE - 80ml CARTRIDGE	1.000	PC	VI1555A0	Ø6 ST. STEEL SCHNOOR KNURLED WASHER	8.000	PC	VI2018A0	M6x1 H6 CH10 BRASS NUT	16.000	PC
Code	Description	Qty	UOM																														
ON1428A0	CHIMNEY HOLDING DISC 30	2.000	PC																														
ON1459A0	FLANGE SEALING CHIMNEY 30 HEAT EXCHANGER	1.000	PC																														
ON1469A0	CHIMNEY SEALING PLATE 30	1.000	PC																														
SL1045A0	S57 BLACK SILICONE - 80ml CARTRIDGE	1.000	PC																														
VI1555A0	Ø6 ST. STEEL SCHNOOR KNURLED WASHER	8.000	PC																														
VI2018A0	M6x1 H6 CH10 BRASS NUT	16.000	PC																														



COMPONENT			SPARE PART																														
Code	Description	Image	Code	Description	Kit components																												
0N1459A	FLANGE SEALING CHIMNEY 30 HEAT EXCHANGER		K0N1459A	D30 CHIMNEY FLANGE KIT	<table border="1"> <thead> <tr> <th>Code</th> <th>Description</th> <th>Qty</th> <th>UOM</th> </tr> </thead> <tbody> <tr> <td>0N1428A0</td> <td>CHIMNEY HOLDING DISC 30</td> <td>2.000</td> <td>PC</td> </tr> <tr> <td>0N1459A0</td> <td>FLANGE SEALING CHIMNEY 30 HEAT EXCHANGER</td> <td>1.000</td> <td>PC</td> </tr> <tr> <td>0N1469A0</td> <td>CHIMNEY SEALING PLATE 30</td> <td>1.000</td> <td>PC</td> </tr> <tr> <td>SL1045A0</td> <td>S57 BLACK SILICONE - 80ml CARTRIDGE</td> <td>1.000</td> <td>PC</td> </tr> <tr> <td>VI1555A0</td> <td>Ø6 ST. STEEL SCHNOOR KNURLED WASHER</td> <td>8.000</td> <td>PC</td> </tr> <tr> <td>VI2018A0</td> <td>M6x1 H6 CH10 BRASS NUT</td> <td>16.000</td> <td>PC</td> </tr> </tbody> </table>	Code	Description	Qty	UOM	0N1428A0	CHIMNEY HOLDING DISC 30	2.000	PC	0N1459A0	FLANGE SEALING CHIMNEY 30 HEAT EXCHANGER	1.000	PC	0N1469A0	CHIMNEY SEALING PLATE 30	1.000	PC	SL1045A0	S57 BLACK SILICONE - 80ml CARTRIDGE	1.000	PC	VI1555A0	Ø6 ST. STEEL SCHNOOR KNURLED WASHER	8.000	PC	VI2018A0	M6x1 H6 CH10 BRASS NUT	16.000	PC
Code	Description	Qty	UOM																														
0N1428A0	CHIMNEY HOLDING DISC 30	2.000	PC																														
0N1459A0	FLANGE SEALING CHIMNEY 30 HEAT EXCHANGER	1.000	PC																														
0N1469A0	CHIMNEY SEALING PLATE 30	1.000	PC																														
SL1045A0	S57 BLACK SILICONE - 80ml CARTRIDGE	1.000	PC																														
VI1555A0	Ø6 ST. STEEL SCHNOOR KNURLED WASHER	8.000	PC																														
VI2018A0	M6x1 H6 CH10 BRASS NUT	16.000	PC																														
0N1469A	CHIMNEY SEALING PLATE 30		K0N1459A	D30 CHIMNEY FLANGE KIT	<table border="1"> <thead> <tr> <th>Code</th> <th>Description</th> <th>Qty</th> <th>UOM</th> </tr> </thead> <tbody> <tr> <td>0N1428A0</td> <td>CHIMNEY HOLDING DISC 30</td> <td>2.000</td> <td>PC</td> </tr> <tr> <td>0N1459A0</td> <td>FLANGE SEALING CHIMNEY 30 HEAT EXCHANGER</td> <td>1.000</td> <td>PC</td> </tr> <tr> <td>0N1469A0</td> <td>CHIMNEY SEALING PLATE 30</td> <td>1.000</td> <td>PC</td> </tr> <tr> <td>SL1045A0</td> <td>S57 BLACK SILICONE - 80ml CARTRIDGE</td> <td>1.000</td> <td>PC</td> </tr> <tr> <td>VI1555A0</td> <td>Ø6 ST. STEEL SCHNOOR KNURLED WASHER</td> <td>8.000</td> <td>PC</td> </tr> <tr> <td>VI2018A0</td> <td>M6x1 H6 CH10 BRASS NUT</td> <td>16.000</td> <td>PC</td> </tr> </tbody> </table>	Code	Description	Qty	UOM	0N1428A0	CHIMNEY HOLDING DISC 30	2.000	PC	0N1459A0	FLANGE SEALING CHIMNEY 30 HEAT EXCHANGER	1.000	PC	0N1469A0	CHIMNEY SEALING PLATE 30	1.000	PC	SL1045A0	S57 BLACK SILICONE - 80ml CARTRIDGE	1.000	PC	VI1555A0	Ø6 ST. STEEL SCHNOOR KNURLED WASHER	8.000	PC	VI2018A0	M6x1 H6 CH10 BRASS NUT	16.000	PC
Code	Description	Qty	UOM																														
0N1428A0	CHIMNEY HOLDING DISC 30	2.000	PC																														
0N1459A0	FLANGE SEALING CHIMNEY 30 HEAT EXCHANGER	1.000	PC																														
0N1469A0	CHIMNEY SEALING PLATE 30	1.000	PC																														
SL1045A0	S57 BLACK SILICONE - 80ml CARTRIDGE	1.000	PC																														
VI1555A0	Ø6 ST. STEEL SCHNOOR KNURLED WASHER	8.000	PC																														
VI2018A0	M6x1 H6 CH10 BRASS NUT	16.000	PC																														
VI1555A	Ø6 ST. STEEL SCHNOOR KNURLED WASHER		VI1555A0	Ø6 ST. STEEL SCHNOOR KNURLED WASHER																													

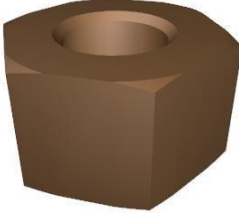

COMPONENT			SPARE PART																										
Code	Description	Image	Code	Description	Kit components																								
VI2018A	M6x1 H6 CH10 BRASS NUT		VI2018A0	M6x1 H6 CH10 BRASS NUT																									
0H8035A	MM CORE PROBE ACCESS COVER		0H8035A0	MM CORE PROBE ACCESS COVER																									
GN1632A	CORE PROBE INLET GASKET		KSN1050B	BIG-L L3200 SINGLE POINT CORE PROBE KIT	<table border="1"> <thead> <tr> <th>Code</th> <th>Description</th> <th>Qty</th> <th>UOM</th> </tr> </thead> <tbody> <tr> <td>0H8120A0</td> <td>XEVL BULB PASS-THROU GH COVER</td> <td>1.000</td> <td>PC</td> </tr> <tr> <td>GN1632A0</td> <td>CORE PROBE INLET GASKET</td> <td>1.000</td> <td>PC</td> </tr> <tr> <td>SL1045A0</td> <td>S57 BLACK SILICONE - 80ml CARTRIDGE</td> <td>1.000</td> <td>PC</td> </tr> <tr> <td>SN1050B0</td> <td>L3200 STRAIGHT MONO.POINT CORE PROBE</td> <td>1.000</td> <td>PC</td> </tr> <tr> <td>VI1220A1</td> <td>4,2x12 TCB SELF-TAPPIN G SCREW</td> <td>3.000</td> <td>PC</td> </tr> </tbody> </table>	Code	Description	Qty	UOM	0H8120A0	XEVL BULB PASS-THROU GH COVER	1.000	PC	GN1632A0	CORE PROBE INLET GASKET	1.000	PC	SL1045A0	S57 BLACK SILICONE - 80ml CARTRIDGE	1.000	PC	SN1050B0	L3200 STRAIGHT MONO.POINT CORE PROBE	1.000	PC	VI1220A1	4,2x12 TCB SELF-TAPPIN G SCREW	3.000	PC
Code	Description	Qty	UOM																										
0H8120A0	XEVL BULB PASS-THROU GH COVER	1.000	PC																										
GN1632A0	CORE PROBE INLET GASKET	1.000	PC																										
SL1045A0	S57 BLACK SILICONE - 80ml CARTRIDGE	1.000	PC																										
SN1050B0	L3200 STRAIGHT MONO.POINT CORE PROBE	1.000	PC																										
VI1220A1	4,2x12 TCB SELF-TAPPIN G SCREW	3.000	PC																										
			KSN1050A	SINGLE POINT CORE PROBE KIT L3200 BIG-L	<table border="1"> <thead> <tr> <th>Code</th> <th>Description</th> <th>Qty</th> <th>UOM</th> </tr> </thead> <tbody> <tr> <td>0H7030A0</td> <td>THERMOSTAT BULB INLET COVER</td> <td>1.000</td> <td>PC</td> </tr> <tr> <td>GN1632A0</td> <td>CORE PROBE INLET GASKET</td> <td>1.000</td> <td>PC</td> </tr> <tr> <td>SL1045A0</td> <td>S57 BLACK SILICONE - 80ml CARTRIDGE</td> <td>1.000</td> <td>PC</td> </tr> <tr> <td>SN1050A1</td> <td>L3200 PEEK MULTI.POINT CORE PROBE</td> <td>1.000</td> <td>PC</td> </tr> <tr> <td>VI1220A1</td> <td>4,2x12 TCB SELF-TAPPIN G SCREW</td> <td>3.000</td> <td>PC</td> </tr> </tbody> </table>	Code	Description	Qty	UOM	0H7030A0	THERMOSTAT BULB INLET COVER	1.000	PC	GN1632A0	CORE PROBE INLET GASKET	1.000	PC	SL1045A0	S57 BLACK SILICONE - 80ml CARTRIDGE	1.000	PC	SN1050A1	L3200 PEEK MULTI.POINT CORE PROBE	1.000	PC	VI1220A1	4,2x12 TCB SELF-TAPPIN G SCREW	3.000	PC
Code	Description	Qty	UOM																										
0H7030A0	THERMOSTAT BULB INLET COVER	1.000	PC																										
GN1632A0	CORE PROBE INLET GASKET	1.000	PC																										
SL1045A0	S57 BLACK SILICONE - 80ml CARTRIDGE	1.000	PC																										
SN1050A1	L3200 PEEK MULTI.POINT CORE PROBE	1.000	PC																										
VI1220A1	4,2x12 TCB SELF-TAPPIN G SCREW	3.000	PC																										



COMPONENT			SPARE PART																										
Code	Description	Image	Code	Description	Kit components																								
GN1632A	CORE PROBE INLET GASKET		KSN1049B	MULTIPOINT CORE PROBE KIT L3200	<table border="1"> <thead> <tr> <th>Code</th> <th>Description</th> <th>Qty</th> <th>UOM</th> </tr> </thead> <tbody> <tr> <td>0H8035A0</td> <td>MM CORE PROBE ACCESS COVE</td> <td>1.000</td> <td>PC</td> </tr> <tr> <td>GN1632A0</td> <td>CORE PROBE INLET GASKET</td> <td>1.000</td> <td>PC</td> </tr> <tr> <td>SL1045A0</td> <td>S57 BLACK SILICONE - 80ml CARTRIDGE</td> <td>1.000</td> <td>PC</td> </tr> <tr> <td>SN1049B0</td> <td>L3200 STRAIGHT MULTIPOINT CORE PROBE</td> <td>1.000</td> <td>PC</td> </tr> <tr> <td>VI1220A1</td> <td>4,2x12 TCB SELF-TAPPIN G SCREW</td> <td>3.000</td> <td>PC</td> </tr> </tbody> </table>	Code	Description	Qty	UOM	0H8035A0	MM CORE PROBE ACCESS COVE	1.000	PC	GN1632A0	CORE PROBE INLET GASKET	1.000	PC	SL1045A0	S57 BLACK SILICONE - 80ml CARTRIDGE	1.000	PC	SN1049B0	L3200 STRAIGHT MULTIPOINT CORE PROBE	1.000	PC	VI1220A1	4,2x12 TCB SELF-TAPPIN G SCREW	3.000	PC
			Code	Description	Qty	UOM																							
			0H8035A0	MM CORE PROBE ACCESS COVE	1.000	PC																							
GN1632A0	CORE PROBE INLET GASKET	1.000	PC																										
SL1045A0	S57 BLACK SILICONE - 80ml CARTRIDGE	1.000	PC																										
SN1049B0	L3200 STRAIGHT MULTIPOINT CORE PROBE	1.000	PC																										
VI1220A1	4,2x12 TCB SELF-TAPPIN G SCREW	3.000	PC																										
KSN1032A	SINGLE POINT CORE PROBE KIT L2750	<table border="1"> <thead> <tr> <th>Code</th> <th>Description</th> <th>Qty</th> <th>UOM</th> </tr> </thead> <tbody> <tr> <td>0H8120A0</td> <td>XEVL BULB PASS-THROU GH COVER</td> <td>1.000</td> <td>PC</td> </tr> <tr> <td>GN1632A0</td> <td>CORE PROBE INLET GASKET</td> <td>1.000</td> <td>PC</td> </tr> <tr> <td>SL1045A0</td> <td>S57 BLACK SILICONE - 80ml CARTRIDGE</td> <td>1.000</td> <td>PC</td> </tr> <tr> <td>SN1032A0</td> <td>L2750 SINGLE POINT CORE PROBE W/O NUT</td> <td>1.000</td> <td>PC</td> </tr> <tr> <td>VI1220A1</td> <td>4,2x12 TCB SELF-TAPPIN G SCREW</td> <td>3.000</td> <td>PC</td> </tr> </tbody> </table>	Code	Description	Qty	UOM	0H8120A0	XEVL BULB PASS-THROU GH COVER	1.000	PC	GN1632A0	CORE PROBE INLET GASKET	1.000	PC	SL1045A0	S57 BLACK SILICONE - 80ml CARTRIDGE	1.000	PC	SN1032A0	L2750 SINGLE POINT CORE PROBE W/O NUT	1.000	PC	VI1220A1	4,2x12 TCB SELF-TAPPIN G SCREW	3.000	PC			
Code	Description	Qty	UOM																										
0H8120A0	XEVL BULB PASS-THROU GH COVER	1.000	PC																										
GN1632A0	CORE PROBE INLET GASKET	1.000	PC																										
SL1045A0	S57 BLACK SILICONE - 80ml CARTRIDGE	1.000	PC																										
SN1032A0	L2750 SINGLE POINT CORE PROBE W/O NUT	1.000	PC																										
VI1220A1	4,2x12 TCB SELF-TAPPIN G SCREW	3.000	PC																										
KSN1031A	SINGLE POINT CORE PROBE KIT L2000	<table border="1"> <thead> <tr> <th>Code</th> <th>Description</th> <th>Qty</th> <th>UOM</th> </tr> </thead> <tbody> <tr> <td>0H8120A0</td> <td>XEVL BULB PASS-THROU GH COVER</td> <td>1.000</td> <td>PC</td> </tr> <tr> <td>GN1632A0</td> <td>CORE PROBE INLET GASKET</td> <td>1.000</td> <td>PC</td> </tr> <tr> <td>SL1045A0</td> <td>S57 BLACK SILICONE - 80ml CARTRIDGE</td> <td>1.000</td> <td>PC</td> </tr> <tr> <td>SN1031A1</td> <td>L2000 SINGLE POINT CORE PROBE W/O NUT</td> <td>1.000</td> <td>PC</td> </tr> <tr> <td>VI1220A1</td> <td>4,2x12 TCB SELF-TAPPIN G SCREW</td> <td>3.000</td> <td>PC</td> </tr> </tbody> </table>	Code	Description	Qty	UOM	0H8120A0	XEVL BULB PASS-THROU GH COVER	1.000	PC	GN1632A0	CORE PROBE INLET GASKET	1.000	PC	SL1045A0	S57 BLACK SILICONE - 80ml CARTRIDGE	1.000	PC	SN1031A1	L2000 SINGLE POINT CORE PROBE W/O NUT	1.000	PC	VI1220A1	4,2x12 TCB SELF-TAPPIN G SCREW	3.000	PC			
Code	Description	Qty	UOM																										
0H8120A0	XEVL BULB PASS-THROU GH COVER	1.000	PC																										
GN1632A0	CORE PROBE INLET GASKET	1.000	PC																										
SL1045A0	S57 BLACK SILICONE - 80ml CARTRIDGE	1.000	PC																										
SN1031A1	L2000 SINGLE POINT CORE PROBE W/O NUT	1.000	PC																										
VI1220A1	4,2x12 TCB SELF-TAPPIN G SCREW	3.000	PC																										



COMPONENT			SPARE PART																																			
Code	Description	Image	Code	Description	Kit components																																	
GN1632A	CORE PROBE INLET GASKET		KSN1030A	SINGLE POINT CORE PROBE KIT L1550	<table border="1"> <thead> <tr> <th>Code</th> <th>Description</th> <th>Qty</th> <th>UOM</th> </tr> </thead> <tbody> <tr> <td>0H8120A0</td> <td>XEVL BULB PASS-THROU GH COVER</td> <td>1.000</td> <td>PC</td> </tr> <tr> <td>GN1632A0</td> <td>CORE PROBE INLET GASKET</td> <td>1.000</td> <td>PC</td> </tr> <tr> <td>SL1045A0</td> <td>S57 BLACK SILICONE - 80ml CARTRIDGE</td> <td>1.000</td> <td>PC</td> </tr> <tr> <td>SN1030A1</td> <td>L1550 MONOPOINT CORE PROBE WITHOUT NUT</td> <td>1.000</td> <td>PC</td> </tr> <tr> <td>VI1220A1</td> <td>4,2x12 TCB SELF-TAPPIN G SCREW</td> <td>3.000</td> <td>PC</td> </tr> </tbody> </table>	Code	Description	Qty	UOM	0H8120A0	XEVL BULB PASS-THROU GH COVER	1.000	PC	GN1632A0	CORE PROBE INLET GASKET	1.000	PC	SL1045A0	S57 BLACK SILICONE - 80ml CARTRIDGE	1.000	PC	SN1030A1	L1550 MONOPOINT CORE PROBE WITHOUT NUT	1.000	PC	VI1220A1	4,2x12 TCB SELF-TAPPIN G SCREW	3.000	PC									
			Code	Description	Qty	UOM																																
			0H8120A0	XEVL BULB PASS-THROU GH COVER	1.000	PC																																
GN1632A0	CORE PROBE INLET GASKET	1.000	PC																																			
SL1045A0	S57 BLACK SILICONE - 80ml CARTRIDGE	1.000	PC																																			
SN1030A1	L1550 MONOPOINT CORE PROBE WITHOUT NUT	1.000	PC																																			
VI1220A1	4,2x12 TCB SELF-TAPPIN G SCREW	3.000	PC																																			
KSN1021B	US MULTI.POINT L2750 CORE PROBE KIT	<table border="1"> <thead> <tr> <th>Code</th> <th>Description</th> <th>Qty</th> <th>UOM</th> </tr> </thead> <tbody> <tr> <td>0H8035A0</td> <td>MM CORE PROBE ACCESS COVE</td> <td>1.000</td> <td>PC</td> </tr> <tr> <td>CE1037A0</td> <td>UL SILICONE GLASS FIBER SHEATH</td> <td>1.500</td> <td>M</td> </tr> <tr> <td>CE1685A0</td> <td>MRT8 P3,81 5 POLES FEMALE TERMINAL</td> <td>1.000</td> <td>PC</td> </tr> <tr> <td>GN1632A0</td> <td>CORE PROBE INLET GASKET</td> <td>1.000</td> <td>PC</td> </tr> <tr> <td>RC1130A0</td> <td>130x2,6 CLAM</td> <td>2.000</td> <td>PC</td> </tr> <tr> <td>SL1045A0</td> <td>S57 BLACK SILICONE - 80ml CARTRIDGE</td> <td>1.000</td> <td>PC</td> </tr> <tr> <td>SN1012B1</td> <td>L2750 MULTIPOINT CORE PROBE WITHOUT NUT</td> <td>1.000</td> <td>PC</td> </tr> <tr> <td>VI1220A1</td> <td>4,2x12 TCB SELF-TAPPIN G SCREW</td> <td>3.000</td> <td>PC</td> </tr> </tbody> </table>	Code	Description	Qty	UOM	0H8035A0	MM CORE PROBE ACCESS COVE	1.000	PC	CE1037A0	UL SILICONE GLASS FIBER SHEATH	1.500	M	CE1685A0	MRT8 P3,81 5 POLES FEMALE TERMINAL	1.000	PC	GN1632A0	CORE PROBE INLET GASKET	1.000	PC	RC1130A0	130x2,6 CLAM	2.000	PC	SL1045A0	S57 BLACK SILICONE - 80ml CARTRIDGE	1.000	PC	SN1012B1	L2750 MULTIPOINT CORE PROBE WITHOUT NUT	1.000	PC	VI1220A1	4,2x12 TCB SELF-TAPPIN G SCREW	3.000	PC
Code	Description	Qty	UOM																																			
0H8035A0	MM CORE PROBE ACCESS COVE	1.000	PC																																			
CE1037A0	UL SILICONE GLASS FIBER SHEATH	1.500	M																																			
CE1685A0	MRT8 P3,81 5 POLES FEMALE TERMINAL	1.000	PC																																			
GN1632A0	CORE PROBE INLET GASKET	1.000	PC																																			
RC1130A0	130x2,6 CLAM	2.000	PC																																			
SL1045A0	S57 BLACK SILICONE - 80ml CARTRIDGE	1.000	PC																																			
SN1012B1	L2750 MULTIPOINT CORE PROBE WITHOUT NUT	1.000	PC																																			
VI1220A1	4,2x12 TCB SELF-TAPPIN G SCREW	3.000	PC																																			
KSN1020B	US MULTIPOINT L2050 CORE PROBE KIT	<table border="1"> <thead> <tr> <th>Code</th> <th>Description</th> <th>Qty</th> <th>UOM</th> </tr> </thead> <tbody> <tr> <td>0H8035A0</td> <td>MM CORE PROBE ACCESS COVE</td> <td>1.000</td> <td>PC</td> </tr> <tr> <td>CE1037A0</td> <td>UL SILICONE GLASS FIBER SHEATH</td> <td>0.700</td> <td>M</td> </tr> <tr> <td>CE1685A0</td> <td>MRT8 P3,81 5 POLES FEMALE TERMINAL</td> <td>1.000</td> <td>PC</td> </tr> </tbody> </table>	Code	Description	Qty	UOM	0H8035A0	MM CORE PROBE ACCESS COVE	1.000	PC	CE1037A0	UL SILICONE GLASS FIBER SHEATH	0.700	M	CE1685A0	MRT8 P3,81 5 POLES FEMALE TERMINAL	1.000	PC																				
Code	Description	Qty	UOM																																			
0H8035A0	MM CORE PROBE ACCESS COVE	1.000	PC																																			
CE1037A0	UL SILICONE GLASS FIBER SHEATH	0.700	M																																			
CE1685A0	MRT8 P3,81 5 POLES FEMALE TERMINAL	1.000	PC																																			



COMPONENT			SPARE PART																																			
Code	Description	Image	Code	Description	Kit components																																	
GN1632A	CORE PROBE INLET GASKET		KSN1020B	US MULTIPOINT L2050 CORE PROBE KIT	<table border="1"> <thead> <tr> <th>Code</th> <th>Description</th> <th>Qty</th> <th>UOM</th> </tr> </thead> <tbody> <tr> <td>GN1632A0</td> <td>CORE PROBE INLET GASKET</td> <td>1.000</td> <td>PC</td> </tr> <tr> <td>RC1130A0</td> <td>130x2,6 CLAM</td> <td>2.000</td> <td>PC</td> </tr> <tr> <td>SL1045A0</td> <td>S57 BLACK SILICONE - 80ml CARTRIDGE</td> <td>1.000</td> <td>PC</td> </tr> <tr> <td>SN1002B1</td> <td>L2050 MULTIPOINT CORE PROBE WITHOUT NUT</td> <td>1.000</td> <td>PC</td> </tr> <tr> <td>VI1220A1</td> <td>4,2x12 TCB SELF-TAPPIN G SCREW</td> <td>3.000</td> <td>PC</td> </tr> </tbody> </table>	Code	Description	Qty	UOM	GN1632A0	CORE PROBE INLET GASKET	1.000	PC	RC1130A0	130x2,6 CLAM	2.000	PC	SL1045A0	S57 BLACK SILICONE - 80ml CARTRIDGE	1.000	PC	SN1002B1	L2050 MULTIPOINT CORE PROBE WITHOUT NUT	1.000	PC	VI1220A1	4,2x12 TCB SELF-TAPPIN G SCREW	3.000	PC									
			Code	Description	Qty	UOM																																
			GN1632A0	CORE PROBE INLET GASKET	1.000	PC																																
RC1130A0	130x2,6 CLAM	2.000	PC																																			
SL1045A0	S57 BLACK SILICONE - 80ml CARTRIDGE	1.000	PC																																			
SN1002B1	L2050 MULTIPOINT CORE PROBE WITHOUT NUT	1.000	PC																																			
VI1220A1	4,2x12 TCB SELF-TAPPIN G SCREW	3.000	PC																																			
KSN1019B	US MULTI.POINT L1550 CORE PROBE KIT	<table border="1"> <thead> <tr> <th>Code</th> <th>Description</th> <th>Qty</th> <th>UOM</th> </tr> </thead> <tbody> <tr> <td>0H8035A0</td> <td>MM CORE PROBE ACCESS COVE</td> <td>1.000</td> <td>PC</td> </tr> <tr> <td>CE1037A0</td> <td>UL SILICONE GLASS FIBER SHEATH</td> <td>0.600</td> <td>M</td> </tr> <tr> <td>CE1685A0</td> <td>MRT8 P3,81 5 POLES FEMALE TERMINAL</td> <td>1.000</td> <td>PC</td> </tr> <tr> <td>GN1632A0</td> <td>CORE PROBE INLET GASKET</td> <td>1.000</td> <td>PC</td> </tr> <tr> <td>RC1130A0</td> <td>130x2,6 CLAM</td> <td>2.000</td> <td>PC</td> </tr> <tr> <td>SL1045A0</td> <td>S57 BLACK SILICONE - 80ml CARTRIDGE</td> <td>1.000</td> <td>PC</td> </tr> <tr> <td>SN1000B1</td> <td>L1550 MULTIPOINT CORE PROBE WITHOUT NUT</td> <td>1.000</td> <td>PC</td> </tr> <tr> <td>VI1220A1</td> <td>4,2x12 TCB SELF-TAPPIN G SCREW</td> <td>3.000</td> <td>PC</td> </tr> </tbody> </table>	Code	Description	Qty	UOM	0H8035A0	MM CORE PROBE ACCESS COVE	1.000	PC	CE1037A0	UL SILICONE GLASS FIBER SHEATH	0.600	M	CE1685A0	MRT8 P3,81 5 POLES FEMALE TERMINAL	1.000	PC	GN1632A0	CORE PROBE INLET GASKET	1.000	PC	RC1130A0	130x2,6 CLAM	2.000	PC	SL1045A0	S57 BLACK SILICONE - 80ml CARTRIDGE	1.000	PC	SN1000B1	L1550 MULTIPOINT CORE PROBE WITHOUT NUT	1.000	PC	VI1220A1	4,2x12 TCB SELF-TAPPIN G SCREW	3.000	PC
Code	Description	Qty	UOM																																			
0H8035A0	MM CORE PROBE ACCESS COVE	1.000	PC																																			
CE1037A0	UL SILICONE GLASS FIBER SHEATH	0.600	M																																			
CE1685A0	MRT8 P3,81 5 POLES FEMALE TERMINAL	1.000	PC																																			
GN1632A0	CORE PROBE INLET GASKET	1.000	PC																																			
RC1130A0	130x2,6 CLAM	2.000	PC																																			
SL1045A0	S57 BLACK SILICONE - 80ml CARTRIDGE	1.000	PC																																			
SN1000B1	L1550 MULTIPOINT CORE PROBE WITHOUT NUT	1.000	PC																																			
VI1220A1	4,2x12 TCB SELF-TAPPIN G SCREW	3.000	PC																																			
KSN1012B	MULTIPOINT CORE PROBE KIT L2750	<table border="1"> <thead> <tr> <th>Code</th> <th>Description</th> <th>Qty</th> <th>UOM</th> </tr> </thead> <tbody> <tr> <td>0H8035A0</td> <td>MM CORE PROBE ACCESS COVE</td> <td>1.000</td> <td>PC</td> </tr> <tr> <td>CE1685A0</td> <td>MRT8 P3,81 5 POLES FEMALE TERMINAL</td> <td>1.000</td> <td>PC</td> </tr> <tr> <td>GN1632A0</td> <td>CORE PROBE INLET GASKET</td> <td>1.000</td> <td>PC</td> </tr> <tr> <td>SL1045A0</td> <td>S57 BLACK SILICONE - 80ml CARTRIDGE</td> <td>1.000</td> <td>PC</td> </tr> </tbody> </table>	Code	Description	Qty	UOM	0H8035A0	MM CORE PROBE ACCESS COVE	1.000	PC	CE1685A0	MRT8 P3,81 5 POLES FEMALE TERMINAL	1.000	PC	GN1632A0	CORE PROBE INLET GASKET	1.000	PC	SL1045A0	S57 BLACK SILICONE - 80ml CARTRIDGE	1.000	PC																
Code	Description	Qty	UOM																																			
0H8035A0	MM CORE PROBE ACCESS COVE	1.000	PC																																			
CE1685A0	MRT8 P3,81 5 POLES FEMALE TERMINAL	1.000	PC																																			
GN1632A0	CORE PROBE INLET GASKET	1.000	PC																																			
SL1045A0	S57 BLACK SILICONE - 80ml CARTRIDGE	1.000	PC																																			





COMPONENT			SPARE PART																											
Code	Description	Image	Code	Description	Kit components																									
GN1632A	CORE PROBE INLET GASKET		KSN1012B	MULTIPOINT CORE PROBE KIT L2750	<table border="1"> <thead> <tr> <th>Code</th> <th>Description</th> <th>Qty</th> <th>UOM</th> </tr> </thead> <tbody> <tr> <td>SN1012B1</td> <td>L2750 MULTIPOINT CORE PROBE WITHOUT NUT</td> <td>1.000</td> <td>PC</td> </tr> <tr> <td>VI1220A1</td> <td>4,2x12 TCB SELF-TAPPIN G SCREW</td> <td>3.000</td> <td>PC</td> </tr> </tbody> </table>	Code	Description	Qty	UOM	SN1012B1	L2750 MULTIPOINT CORE PROBE WITHOUT NUT	1.000	PC	VI1220A1	4,2x12 TCB SELF-TAPPIN G SCREW	3.000	PC													
			Code	Description	Qty	UOM																								
			SN1012B1	L2750 MULTIPOINT CORE PROBE WITHOUT NUT	1.000	PC																								
VI1220A1	4,2x12 TCB SELF-TAPPIN G SCREW	3.000	PC																											
KSN1002B	MULTIPOINT CORE PROBE KIT L2050	<table border="1"> <thead> <tr> <th>Code</th> <th>Description</th> <th>Qty</th> <th>UOM</th> </tr> </thead> <tbody> <tr> <td>0H8035A0</td> <td>MM CORE PROBE ACCESS COVE</td> <td>1.000</td> <td>PC</td> </tr> <tr> <td>CE1685A0</td> <td>MRT8 P3,81 5 POLES FEMALE TERMINAL</td> <td>1.000</td> <td>PC</td> </tr> <tr> <td>GN1632A0</td> <td>CORE PROBE INLET GASKET</td> <td>1.000</td> <td>PC</td> </tr> <tr> <td>SL1045A0</td> <td>S57 BLACK SILICONE - 80ml CARTRIDGE</td> <td>1.000</td> <td>PC</td> </tr> <tr> <td>SN1002B1</td> <td>L2050 MULTIPOINT CORE PROBE WITHOUT NUT</td> <td>1.000</td> <td>PC</td> </tr> <tr> <td>VI1220A1</td> <td>4,2x12 TCB SELF-TAPPIN G SCREW</td> <td>3.000</td> <td>PC</td> </tr> </tbody> </table>	Code	Description	Qty	UOM	0H8035A0	MM CORE PROBE ACCESS COVE	1.000	PC	CE1685A0	MRT8 P3,81 5 POLES FEMALE TERMINAL	1.000	PC	GN1632A0	CORE PROBE INLET GASKET	1.000	PC	SL1045A0	S57 BLACK SILICONE - 80ml CARTRIDGE	1.000	PC	SN1002B1	L2050 MULTIPOINT CORE PROBE WITHOUT NUT	1.000	PC	VI1220A1	4,2x12 TCB SELF-TAPPIN G SCREW	3.000	PC
Code	Description	Qty	UOM																											
0H8035A0	MM CORE PROBE ACCESS COVE	1.000	PC																											
CE1685A0	MRT8 P3,81 5 POLES FEMALE TERMINAL	1.000	PC																											
GN1632A0	CORE PROBE INLET GASKET	1.000	PC																											
SL1045A0	S57 BLACK SILICONE - 80ml CARTRIDGE	1.000	PC																											
SN1002B1	L2050 MULTIPOINT CORE PROBE WITHOUT NUT	1.000	PC																											
VI1220A1	4,2x12 TCB SELF-TAPPIN G SCREW	3.000	PC																											
KSN1000B	MULTIPOINT CORE PROBE KIT L1550	<table border="1"> <thead> <tr> <th>Code</th> <th>Description</th> <th>Qty</th> <th>UOM</th> </tr> </thead> <tbody> <tr> <td>0H8035A0</td> <td>MM CORE PROBE ACCESS COVE</td> <td>1.000</td> <td>PC</td> </tr> <tr> <td>CE1685A0</td> <td>MRT8 P3,81 5 POLES FEMALE TERMINAL</td> <td>1.000</td> <td>PC</td> </tr> <tr> <td>GN1632A0</td> <td>CORE PROBE INLET GASKET</td> <td>1.000</td> <td>PC</td> </tr> <tr> <td>SL1045A0</td> <td>S57 BLACK SILICONE - 80ml CARTRIDGE</td> <td>1.000</td> <td>PC</td> </tr> <tr> <td>SN1000B1</td> <td>L1550 MULTIPOINT CORE PROBE WITHOUT NUT</td> <td>1.000</td> <td>PC</td> </tr> <tr> <td>VI1220A1</td> <td>4,2x12 TCB SELF-TAPPIN G SCREW</td> <td>3.000</td> <td>PC</td> </tr> </tbody> </table>	Code	Description	Qty	UOM	0H8035A0	MM CORE PROBE ACCESS COVE	1.000	PC	CE1685A0	MRT8 P3,81 5 POLES FEMALE TERMINAL	1.000	PC	GN1632A0	CORE PROBE INLET GASKET	1.000	PC	SL1045A0	S57 BLACK SILICONE - 80ml CARTRIDGE	1.000	PC	SN1000B1	L1550 MULTIPOINT CORE PROBE WITHOUT NUT	1.000	PC	VI1220A1	4,2x12 TCB SELF-TAPPIN G SCREW	3.000	PC
Code	Description	Qty	UOM																											
0H8035A0	MM CORE PROBE ACCESS COVE	1.000	PC																											
CE1685A0	MRT8 P3,81 5 POLES FEMALE TERMINAL	1.000	PC																											
GN1632A0	CORE PROBE INLET GASKET	1.000	PC																											
SL1045A0	S57 BLACK SILICONE - 80ml CARTRIDGE	1.000	PC																											
SN1000B1	L1550 MULTIPOINT CORE PROBE WITHOUT NUT	1.000	PC																											
VI1220A1	4,2x12 TCB SELF-TAPPIN G SCREW	3.000	PC																											



COMPONENT			SPARE PART																		
Code	Description	Image	Code	Description	Kit components																
GN1631A	GN1626A- 1011 2654MM DOOR GASKET		KG1631A	1011 DOOR GASKET KIT	<table border="1"> <thead> <tr> <th>Code</th> <th>Description</th> <th>Qty</th> <th>UOM</th> </tr> </thead> <tbody> <tr> <td>GN1631A0</td> <td>GN1626A- 1011 2654MM DOOR GASKE</td> <td>1.000</td> <td>PC</td> </tr> <tr> <td>VM2277A0</td> <td>DOOR SEAL KIT INTERNAL CONNECTION</td> <td>1.000</td> <td>PC</td> </tr> </tbody> </table>	Code	Description	Qty	UOM	GN1631A0	GN1626A- 1011 2654MM DOOR GASKE	1.000	PC	VM2277A0	DOOR SEAL KIT INTERNAL CONNECTION	1.000	PC				
Code	Description	Qty	UOM																		
GN1631A0	GN1626A- 1011 2654MM DOOR GASKE	1.000	PC																		
VM2277A0	DOOR SEAL KIT INTERNAL CONNECTION	1.000	PC																		
TB2902A	CHAMBER CHIMNEY PIPE D50		TB2902A0	CHAMBER CHIMNEY PIPE D50																	
ON1415A	BLOWER CONNECTION PLAT		ON1415A0	BLOWER CONNECTION PLAT																	
ON1126A	COMPLETE BLOWER RAMP		KON1126A	COMPLETE GAS BLOWING RAMP KIT	<table border="1"> <thead> <tr> <th>Code</th> <th>Description</th> <th>Qty</th> <th>UOM</th> </tr> </thead> <tbody> <tr> <td>ON1126A0</td> <td>COMPLETE BLOWER RAM</td> <td>1.000</td> <td>PC</td> </tr> <tr> <td>GN1542A0</td> <td>GAS PIPE 1"GAS FITTING ALLUMINIUM WASHER</td> <td>2.000</td> <td>PC</td> </tr> <tr> <td>V11310A0</td> <td>ZINC THREAD INSERT M6 FTR/E</td> <td>4.000</td> <td>PC</td> </tr> </tbody> </table>	Code	Description	Qty	UOM	ON1126A0	COMPLETE BLOWER RAM	1.000	PC	GN1542A0	GAS PIPE 1"GAS FITTING ALLUMINIUM WASHER	2.000	PC	V11310A0	ZINC THREAD INSERT M6 FTR/E	4.000	PC
Code	Description	Qty	UOM																		
ON1126A0	COMPLETE BLOWER RAM	1.000	PC																		
GN1542A0	GAS PIPE 1"GAS FITTING ALLUMINIUM WASHER	2.000	PC																		
V11310A0	ZINC THREAD INSERT M6 FTR/E	4.000	PC																		
GN1542A	GAS PIPE 1"GAS FITTING ALLUMINIUM WASHER		KG1569A	GAS TORCH SEALINGS KIT	<table border="1"> <thead> <tr> <th>Code</th> <th>Description</th> <th>Qty</th> <th>UOM</th> </tr> </thead> <tbody> <tr> <td>GN1541A0</td> <td>PREMIX BLOWER-SUP PORT GASKET</td> <td>2.000</td> <td>PC</td> </tr> <tr> <td>GN1542A0</td> <td>GAS PIPE 1"GAS FITTING ALLUMINIUM WASHER</td> <td>4.000</td> <td>PC</td> </tr> <tr> <td>GN1543A0</td> <td>PREMIX START-UP PLUG GASKET</td> <td>6.000</td> <td>PC</td> </tr> </tbody> </table>	Code	Description	Qty	UOM	GN1541A0	PREMIX BLOWER-SUP PORT GASKET	2.000	PC	GN1542A0	GAS PIPE 1"GAS FITTING ALLUMINIUM WASHER	4.000	PC	GN1543A0	PREMIX START-UP PLUG GASKET	6.000	PC
Code	Description	Qty	UOM																		
GN1541A0	PREMIX BLOWER-SUP PORT GASKET	2.000	PC																		
GN1542A0	GAS PIPE 1"GAS FITTING ALLUMINIUM WASHER	4.000	PC																		
GN1543A0	PREMIX START-UP PLUG GASKET	6.000	PC																		



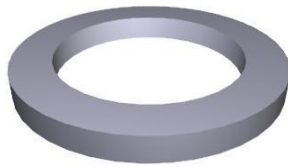

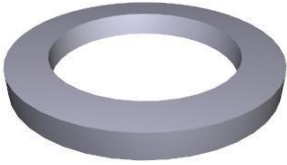
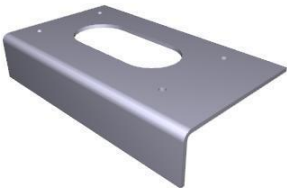

COMPONENT			SPARE PART																																						
Code	Description	Image	Code	Description	Kit components																																				
GN1542A	GAS PIPE 1"GAS FITTING ALLUMINIUM WASHER		KG1569A	GAS TORCH SEALINGS KIT	<table border="1"> <thead> <tr> <th>Code</th> <th>Description</th> <th>Qty</th> <th>UOM</th> </tr> </thead> <tbody> <tr> <td>GN1548A0</td> <td>"3/4" GAS PIPE ALLUMINIUM WASHER"</td> <td>4.000</td> <td>PC</td> </tr> <tr> <td>GN1551A2</td> <td>TORCH-CHAMBER SEALING</td> <td>2.000</td> <td>PC</td> </tr> <tr> <td>GN1559A0</td> <td>O-RING NBR 2087 21,95x1,7</td> <td>2.000</td> <td>PC</td> </tr> <tr> <td>GN1586A2</td> <td>TORCH LOWER SEALING</td> <td>2.000</td> <td>PC</td> </tr> <tr> <td>VI1521A0</td> <td>STAINLESS STEEL WASHER D=6 6592</td> <td>6.000</td> <td>PC</td> </tr> </tbody> </table>	Code	Description	Qty	UOM	GN1548A0	"3/4" GAS PIPE ALLUMINIUM WASHER"	4.000	PC	GN1551A2	TORCH-CHAMBER SEALING	2.000	PC	GN1559A0	O-RING NBR 2087 21,95x1,7	2.000	PC	GN1586A2	TORCH LOWER SEALING	2.000	PC	VI1521A0	STAINLESS STEEL WASHER D=6 6592	6.000	PC												
Code	Description	Qty	UOM																																						
GN1548A0	"3/4" GAS PIPE ALLUMINIUM WASHER"	4.000	PC																																						
GN1551A2	TORCH-CHAMBER SEALING	2.000	PC																																						
GN1559A0	O-RING NBR 2087 21,95x1,7	2.000	PC																																						
GN1586A2	TORCH LOWER SEALING	2.000	PC																																						
VI1521A0	STAINLESS STEEL WASHER D=6 6592	6.000	PC																																						
GN1541A	PREMIX BLOWER-SUPPORT GASKET		KG1569A	GAS TORCH SEALINGS KIT	<table border="1"> <thead> <tr> <th>Code</th> <th>Description</th> <th>Qty</th> <th>UOM</th> </tr> </thead> <tbody> <tr> <td>GN1541A0</td> <td>PREMIX BLOWER-SUP PORT GASKET</td> <td>2.000</td> <td>PC</td> </tr> <tr> <td>GN1542A0</td> <td>GAS PIPE 1"GAS FITTING ALLUMINIUM WASHER</td> <td>4.000</td> <td>PC</td> </tr> <tr> <td>GN1543A0</td> <td>PREMIX START-UP PLUG GASKET</td> <td>6.000</td> <td>PC</td> </tr> <tr> <td>GN1548A0</td> <td>"3/4" GAS PIPE ALLUMINIUM WASHER"</td> <td>4.000</td> <td>PC</td> </tr> <tr> <td>GN1551A2</td> <td>TORCH-CHAMBER SEALING</td> <td>2.000</td> <td>PC</td> </tr> <tr> <td>GN1559A0</td> <td>O-RING NBR 2087 21,95x1,7</td> <td>2.000</td> <td>PC</td> </tr> <tr> <td>GN1586A2</td> <td>TORCH LOWER SEALING</td> <td>2.000</td> <td>PC</td> </tr> <tr> <td>VI1521A0</td> <td>STAINLESS STEEL WASHER D=6 6592</td> <td>6.000</td> <td>PC</td> </tr> </tbody> </table>	Code	Description	Qty	UOM	GN1541A0	PREMIX BLOWER-SUP PORT GASKET	2.000	PC	GN1542A0	GAS PIPE 1"GAS FITTING ALLUMINIUM WASHER	4.000	PC	GN1543A0	PREMIX START-UP PLUG GASKET	6.000	PC	GN1548A0	"3/4" GAS PIPE ALLUMINIUM WASHER"	4.000	PC	GN1551A2	TORCH-CHAMBER SEALING	2.000	PC	GN1559A0	O-RING NBR 2087 21,95x1,7	2.000	PC	GN1586A2	TORCH LOWER SEALING	2.000	PC	VI1521A0	STAINLESS STEEL WASHER D=6 6592	6.000	PC
Code	Description	Qty	UOM																																						
GN1541A0	PREMIX BLOWER-SUP PORT GASKET	2.000	PC																																						
GN1542A0	GAS PIPE 1"GAS FITTING ALLUMINIUM WASHER	4.000	PC																																						
GN1543A0	PREMIX START-UP PLUG GASKET	6.000	PC																																						
GN1548A0	"3/4" GAS PIPE ALLUMINIUM WASHER"	4.000	PC																																						
GN1551A2	TORCH-CHAMBER SEALING	2.000	PC																																						
GN1559A0	O-RING NBR 2087 21,95x1,7	2.000	PC																																						
GN1586A2	TORCH LOWER SEALING	2.000	PC																																						
VI1521A0	STAINLESS STEEL WASHER D=6 6592	6.000	PC																																						
GN1548A	"3/4" GAS PIPE ALLUMINIUM WASHER"		KG1569A	GAS TORCH SEALINGS KIT	<table border="1"> <thead> <tr> <th>Code</th> <th>Description</th> <th>Qty</th> <th>UOM</th> </tr> </thead> <tbody> <tr> <td>GN1541A0</td> <td>PREMIX BLOWER-SUP PORT GASKET</td> <td>2.000</td> <td>PC</td> </tr> <tr> <td>GN1542A0</td> <td>GAS PIPE 1"GAS FITTING ALLUMINIUM WASHER</td> <td>4.000</td> <td>PC</td> </tr> </tbody> </table>	Code	Description	Qty	UOM	GN1541A0	PREMIX BLOWER-SUP PORT GASKET	2.000	PC	GN1542A0	GAS PIPE 1"GAS FITTING ALLUMINIUM WASHER	4.000	PC																								
Code	Description	Qty	UOM																																						
GN1541A0	PREMIX BLOWER-SUP PORT GASKET	2.000	PC																																						
GN1542A0	GAS PIPE 1"GAS FITTING ALLUMINIUM WASHER	4.000	PC																																						



COMPONENT			SPARE PART																																						
Code	Description	Image	Code	Description	Kit components																																				
GN1548A	"3/4"" GAS PIPE ALLUMINIUM WASHER"		KGN1569A	GAS TORCH SEALINGS KIT	<table border="1"> <thead> <tr> <th>Code</th> <th>Description</th> <th>Qty</th> <th>UOM</th> </tr> </thead> <tbody> <tr> <td>GN1543A0</td> <td>PREMIX START-UP PLUG GASKET</td> <td>6.000</td> <td>PC</td> </tr> <tr> <td>GN1548A0</td> <td>"3/4"" GAS PIPE ALLUMINIUM WASHER"</td> <td>4.000</td> <td>PC</td> </tr> <tr> <td>GN1551A2</td> <td>TORCH-CHAM BER SEALING</td> <td>2.000</td> <td>PC</td> </tr> <tr> <td>GN1559A0</td> <td>O-RING NBR 2087 21,95x1,7</td> <td>2.000</td> <td>PC</td> </tr> <tr> <td>GN1586A2</td> <td>TORCH LOWER SEALING</td> <td>2.000</td> <td>PC</td> </tr> <tr> <td>VI1521A0</td> <td>STAINLESS STEEL WASHER D=6 6592</td> <td>6.000</td> <td>PC</td> </tr> </tbody> </table>	Code	Description	Qty	UOM	GN1543A0	PREMIX START-UP PLUG GASKET	6.000	PC	GN1548A0	"3/4"" GAS PIPE ALLUMINIUM WASHER"	4.000	PC	GN1551A2	TORCH-CHAM BER SEALING	2.000	PC	GN1559A0	O-RING NBR 2087 21,95x1,7	2.000	PC	GN1586A2	TORCH LOWER SEALING	2.000	PC	VI1521A0	STAINLESS STEEL WASHER D=6 6592	6.000	PC								
Code	Description	Qty	UOM																																						
GN1543A0	PREMIX START-UP PLUG GASKET	6.000	PC																																						
GN1548A0	"3/4"" GAS PIPE ALLUMINIUM WASHER"	4.000	PC																																						
GN1551A2	TORCH-CHAM BER SEALING	2.000	PC																																						
GN1559A0	O-RING NBR 2087 21,95x1,7	2.000	PC																																						
GN1586A2	TORCH LOWER SEALING	2.000	PC																																						
VI1521A0	STAINLESS STEEL WASHER D=6 6592	6.000	PC																																						
GN1551A	TORCH-CHAMBER SEALING		KGN1569A	GAS TORCH SEALINGS KIT	<table border="1"> <thead> <tr> <th>Code</th> <th>Description</th> <th>Qty</th> <th>UOM</th> </tr> </thead> <tbody> <tr> <td>GN1541A0</td> <td>PREMIX BLOWER-SUP PORT GASKET</td> <td>2.000</td> <td>PC</td> </tr> <tr> <td>GN1542A0</td> <td>GAS PIPE 1"GAS FITTING ALLUMINIUM WASHER</td> <td>4.000</td> <td>PC</td> </tr> <tr> <td>GN1543A0</td> <td>PREMIX START-UP PLUG GASKET</td> <td>6.000</td> <td>PC</td> </tr> <tr> <td>GN1548A0</td> <td>"3/4"" GAS PIPE ALLUMINIUM WASHER"</td> <td>4.000</td> <td>PC</td> </tr> <tr> <td>GN1551A2</td> <td>TORCH-CHAM BER SEALING</td> <td>2.000</td> <td>PC</td> </tr> <tr> <td>GN1559A0</td> <td>O-RING NBR 2087 21,95x1,7</td> <td>2.000</td> <td>PC</td> </tr> <tr> <td>GN1586A2</td> <td>TORCH LOWER SEALING</td> <td>2.000</td> <td>PC</td> </tr> <tr> <td>VI1521A0</td> <td>STAINLESS STEEL WASHER D=6 6592</td> <td>6.000</td> <td>PC</td> </tr> </tbody> </table>	Code	Description	Qty	UOM	GN1541A0	PREMIX BLOWER-SUP PORT GASKET	2.000	PC	GN1542A0	GAS PIPE 1"GAS FITTING ALLUMINIUM WASHER	4.000	PC	GN1543A0	PREMIX START-UP PLUG GASKET	6.000	PC	GN1548A0	"3/4"" GAS PIPE ALLUMINIUM WASHER"	4.000	PC	GN1551A2	TORCH-CHAM BER SEALING	2.000	PC	GN1559A0	O-RING NBR 2087 21,95x1,7	2.000	PC	GN1586A2	TORCH LOWER SEALING	2.000	PC	VI1521A0	STAINLESS STEEL WASHER D=6 6592	6.000	PC
Code	Description	Qty	UOM																																						
GN1541A0	PREMIX BLOWER-SUP PORT GASKET	2.000	PC																																						
GN1542A0	GAS PIPE 1"GAS FITTING ALLUMINIUM WASHER	4.000	PC																																						
GN1543A0	PREMIX START-UP PLUG GASKET	6.000	PC																																						
GN1548A0	"3/4"" GAS PIPE ALLUMINIUM WASHER"	4.000	PC																																						
GN1551A2	TORCH-CHAM BER SEALING	2.000	PC																																						
GN1559A0	O-RING NBR 2087 21,95x1,7	2.000	PC																																						
GN1586A2	TORCH LOWER SEALING	2.000	PC																																						
VI1521A0	STAINLESS STEEL WASHER D=6 6592	6.000	PC																																						



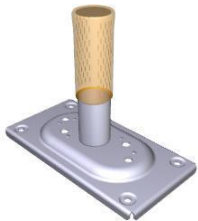

COMPONENT			SPARE PART																										
Code	Description	Image	Code	Description	Kit components																								
RC1045A	3/4" FEM-3/4" MALE THREADED STRAIGHT		RC1045A1	3/4 FEMALE-3/4 STRAIGHT GAS FITTING																									
RC1394A	FLEXIBLE REVOLVING 3/4 GAS F-F FITTING		KRC1394A	3/4 GAS FLEXIBLE CONNECTION KIT	<table border="1"> <thead> <tr> <th>Code</th> <th>Description</th> <th>Qty</th> <th>UOM</th> </tr> </thead> <tbody> <tr> <td>GN1548A0</td> <td>"3/4" GAS PIPE ALLUMINIUM WASHER"</td> <td>2.000</td> <td>PC</td> </tr> <tr> <td>RC1394A0</td> <td>FLEXIBLE REVOLVING 3/4 GAS F-F FITTING</td> <td>1.000</td> <td>PC</td> </tr> </tbody> </table>	Code	Description	Qty	UOM	GN1548A0	"3/4" GAS PIPE ALLUMINIUM WASHER"	2.000	PC	RC1394A0	FLEXIBLE REVOLVING 3/4 GAS F-F FITTING	1.000	PC												
Code	Description	Qty	UOM																										
GN1548A0	"3/4" GAS PIPE ALLUMINIUM WASHER"	2.000	PC																										
RC1394A0	FLEXIBLE REVOLVING 3/4 GAS F-F FITTING	1.000	PC																										
VG1014C	230V-45KW MAX PREMIX GROUP		KVG1014C	230V 45KW MAX VENTURI-PREMIX BLOWER KIT	<table border="1"> <thead> <tr> <th>Code</th> <th>Description</th> <th>Qty</th> <th>UOM</th> </tr> </thead> <tbody> <tr> <td>GN1415A0</td> <td>BLOWER CONNECTION PLATE</td> <td>1.000</td> <td>PC</td> </tr> <tr> <td>GN1541A0</td> <td>PREMIX BLOWER-SUP PORT GASKET</td> <td>1.000</td> <td>PC</td> </tr> <tr> <td>VG1014C0</td> <td>230V-45KW MAX PREMIX GROUP</td> <td>1.000</td> <td>PC</td> </tr> <tr> <td>VI2008A1</td> <td>ST STEEL NOTCHED M5 WASHER</td> <td>4.000</td> <td>PC</td> </tr> <tr> <td>VI2021A0</td> <td>M5X0.8 H5 CH 8 BRASS NUT</td> <td>4.000</td> <td>PC</td> </tr> </tbody> </table>	Code	Description	Qty	UOM	GN1415A0	BLOWER CONNECTION PLATE	1.000	PC	GN1541A0	PREMIX BLOWER-SUP PORT GASKET	1.000	PC	VG1014C0	230V-45KW MAX PREMIX GROUP	1.000	PC	VI2008A1	ST STEEL NOTCHED M5 WASHER	4.000	PC	VI2021A0	M5X0.8 H5 CH 8 BRASS NUT	4.000	PC
Code	Description	Qty	UOM																										
GN1415A0	BLOWER CONNECTION PLATE	1.000	PC																										
GN1541A0	PREMIX BLOWER-SUP PORT GASKET	1.000	PC																										
VG1014C0	230V-45KW MAX PREMIX GROUP	1.000	PC																										
VI2008A1	ST STEEL NOTCHED M5 WASHER	4.000	PC																										
VI2021A0	M5X0.8 H5 CH 8 BRASS NUT	4.000	PC																										
VG1094A	14kW TORCH AND P 11 PLUGS SET		VG1094A0	14kW TORCH AND P 11 PLUGS SET																									

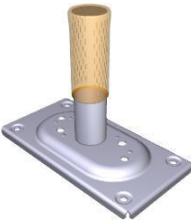

COMPONENT			SPARE PART																																																						
Code	Description	Image	Code	Description	Kit components																																																				
BR1340A	PREMIX START-UP PLUG		KBR1340A	PREMIX BURNER START UP PLUG 6 PCS KIT	<table border="1"> <thead> <tr> <th>Code</th> <th>Description</th> <th>Qty</th> <th>UOM</th> </tr> </thead> <tbody> <tr> <td>BR1340A2</td> <td>PREMIX START-UP PLUG</td> <td>6.000</td> <td>PC</td> </tr> <tr> <td>GN1542A0</td> <td>GAS PIPE 1"GAS FITTING ALLUMINIUM WASHER</td> <td>4.000</td> <td>PC</td> </tr> <tr> <td>GN1543A0</td> <td>PREMIX START-UP PLUG GASKET</td> <td>6.000</td> <td>PC</td> </tr> <tr> <td>GN1551A2</td> <td>TORCH-CHAMBER SEALING</td> <td>2.000</td> <td>PC</td> </tr> <tr> <td>GN1580B0</td> <td>M8 TIE ROD GASKET</td> <td>4.000</td> <td>PC</td> </tr> <tr> <td>GN1586A2</td> <td>TORCH LOWER SEALING</td> <td>2.000</td> <td>PC</td> </tr> <tr> <td>VI0504A1</td> <td>M4 SERRATED WASHER</td> <td>12.000</td> <td>PC</td> </tr> <tr> <td>VI2020A0</td> <td>M4x1 H4 CH 7 BRASS NUT</td> <td>12.000</td> <td>PC</td> </tr> </tbody> </table>	Code	Description	Qty	UOM	BR1340A2	PREMIX START-UP PLUG	6.000	PC	GN1542A0	GAS PIPE 1"GAS FITTING ALLUMINIUM WASHER	4.000	PC	GN1543A0	PREMIX START-UP PLUG GASKET	6.000	PC	GN1551A2	TORCH-CHAMBER SEALING	2.000	PC	GN1580B0	M8 TIE ROD GASKET	4.000	PC	GN1586A2	TORCH LOWER SEALING	2.000	PC	VI0504A1	M4 SERRATED WASHER	12.000	PC	VI2020A0	M4x1 H4 CH 7 BRASS NUT	12.000	PC																
					Code	Description	Qty	UOM																																																	
					BR1340A2	PREMIX START-UP PLUG	6.000	PC																																																	
					GN1542A0	GAS PIPE 1"GAS FITTING ALLUMINIUM WASHER	4.000	PC																																																	
					GN1543A0	PREMIX START-UP PLUG GASKET	6.000	PC																																																	
					GN1551A2	TORCH-CHAMBER SEALING	2.000	PC																																																	
					GN1580B0	M8 TIE ROD GASKET	4.000	PC																																																	
					GN1586A2	TORCH LOWER SEALING	2.000	PC																																																	
					VI0504A1	M4 SERRATED WASHER	12.000	PC																																																	
					VI2020A0	M4x1 H4 CH 7 BRASS NUT	12.000	PC																																																	
BR1346D	14 KW GAS TORCH + PLATE		KVG1094A	14KW TORCH + P11 IGNITION PLUGS KI	<table border="1"> <thead> <tr> <th>Code</th> <th>Description</th> <th>Qty</th> <th>UOM</th> </tr> </thead> <tbody> <tr> <td>BR1340A2</td> <td>PREMIX START-UP PLUG</td> <td>3.000</td> <td>PC</td> </tr> <tr> <td>BR1346D0</td> <td>14 KW GAS TORCH + PLATE</td> <td>1.000</td> <td>PC</td> </tr> <tr> <td>BR1349A0</td> <td>BR1349A0</td> <td>1.000</td> <td>PC</td> </tr> <tr> <td>GN1542A0</td> <td>GAS PIPE 1"GAS FITTING ALLUMINIUM WASHER</td> <td>1.000</td> <td>PC</td> </tr> <tr> <td>GN1543A0</td> <td>PREMIX START-UP PLUG GASKET</td> <td>3.000</td> <td>PC</td> </tr> <tr> <td>GN1551A2</td> <td>TORCH-CHAMBER SEALING</td> <td>1.000</td> <td>PC</td> </tr> <tr> <td>GN1580B0</td> <td>M8 TIE ROD GASKET</td> <td>2.000</td> <td>PC</td> </tr> <tr> <td>GN1586B0</td> <td>BAFFLE CHIMNEY</td> <td>1.000</td> <td>PC</td> </tr> <tr> <td>RC1385B0</td> <td>FLEXIBLE REVOLVING 1 GAS F-F FITTING</td> <td>1.000</td> <td>PC</td> </tr> <tr> <td>VI0504A1</td> <td>M4 SERRATED WASHER</td> <td>6.000</td> <td>PC</td> </tr> <tr> <td>VI2009A2</td> <td>GAS PIPE SCREW BRASS WASHER</td> <td>3.000</td> <td>PC</td> </tr> <tr> <td>VI2020A0</td> <td>M4x1 H4 CH 7 BRASS NUT</td> <td>6.000</td> <td>PC</td> </tr> </tbody> </table>	Code	Description	Qty	UOM	BR1340A2	PREMIX START-UP PLUG	3.000	PC	BR1346D0	14 KW GAS TORCH + PLATE	1.000	PC	BR1349A0	BR1349A0	1.000	PC	GN1542A0	GAS PIPE 1"GAS FITTING ALLUMINIUM WASHER	1.000	PC	GN1543A0	PREMIX START-UP PLUG GASKET	3.000	PC	GN1551A2	TORCH-CHAMBER SEALING	1.000	PC	GN1580B0	M8 TIE ROD GASKET	2.000	PC	GN1586B0	BAFFLE CHIMNEY	1.000	PC	RC1385B0	FLEXIBLE REVOLVING 1 GAS F-F FITTING	1.000	PC	VI0504A1	M4 SERRATED WASHER	6.000	PC	VI2009A2	GAS PIPE SCREW BRASS WASHER	3.000	PC	VI2020A0	M4x1 H4 CH 7 BRASS NUT	6.000	PC
					Code	Description	Qty	UOM																																																	
					BR1340A2	PREMIX START-UP PLUG	3.000	PC																																																	
					BR1346D0	14 KW GAS TORCH + PLATE	1.000	PC																																																	
					BR1349A0	BR1349A0	1.000	PC																																																	
					GN1542A0	GAS PIPE 1"GAS FITTING ALLUMINIUM WASHER	1.000	PC																																																	
					GN1543A0	PREMIX START-UP PLUG GASKET	3.000	PC																																																	
					GN1551A2	TORCH-CHAMBER SEALING	1.000	PC																																																	
					GN1580B0	M8 TIE ROD GASKET	2.000	PC																																																	
					GN1586B0	BAFFLE CHIMNEY	1.000	PC																																																	
					RC1385B0	FLEXIBLE REVOLVING 1 GAS F-F FITTING	1.000	PC																																																	
					VI0504A1	M4 SERRATED WASHER	6.000	PC																																																	
					VI2009A2	GAS PIPE SCREW BRASS WASHER	3.000	PC																																																	
					VI2020A0	M4x1 H4 CH 7 BRASS NUT	6.000	PC																																																	

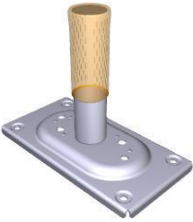
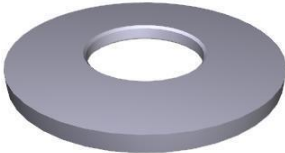

COMPONENT			SPARE PART																																																																																	
Code	Description	Image	Code	Description	Kit components																																																																															
BR1346D	14 KW GAS TORCH + PLATE		KVG1092A	14kW TORCH+ P 14 IGNITION PLUGS SET KIT	<table border="1"> <thead> <tr> <th>Code</th> <th>Description</th> <th>Qty</th> <th>UOM</th> </tr> </thead> <tbody> <tr> <td>BR1340A2</td> <td>PREMIX START-UP PLUG</td> <td>3.000</td> <td>PC</td> </tr> <tr> <td>BR1346D0</td> <td>14 KW GAS TORCH + PLATE</td> <td>1.000</td> <td>PC</td> </tr> <tr> <td>BR1361A0</td> <td>D14 REDUCTION PLATE</td> <td>1.000</td> <td>PC</td> </tr> <tr> <td>GN1542A0</td> <td>GAS PIPE 1"GAS FITTING ALLUMINIUM WASHER</td> <td>1.000</td> <td>PC</td> </tr> <tr> <td>GN1543A0</td> <td>PREMIX START-UP PLUG GASKET</td> <td>3.000</td> <td>PC</td> </tr> <tr> <td>GN1551A2</td> <td>TORCH-CHAM BER SEALING</td> <td>1.000</td> <td>PC</td> </tr> <tr> <td>GN1580B0</td> <td>M8 TIE ROD GASKET</td> <td>2.000</td> <td>PC</td> </tr> <tr> <td>GN1586B0</td> <td>BAFFLE CHIMNEY</td> <td>1.000</td> <td>PC</td> </tr> <tr> <td>RC1385B0</td> <td>FLEXIBLE REVOLVING 1 GAS F-F FITTING</td> <td>1.000</td> <td>PC</td> </tr> <tr> <td>VI0504A1</td> <td>M4 SERRATED WASHER</td> <td>6.000</td> <td>PC</td> </tr> <tr> <td>VI2009A2</td> <td>GAS PIPE SCREW BRASS WASHER</td> <td>3.000</td> <td>PC</td> </tr> <tr> <td>VI2020A0</td> <td>M4x1 H4 CH 7 BRASS NUT</td> <td>6.000</td> <td>PC</td> </tr> </tbody> </table>	Code	Description	Qty	UOM	BR1340A2	PREMIX START-UP PLUG	3.000	PC	BR1346D0	14 KW GAS TORCH + PLATE	1.000	PC	BR1361A0	D14 REDUCTION PLATE	1.000	PC	GN1542A0	GAS PIPE 1"GAS FITTING ALLUMINIUM WASHER	1.000	PC	GN1543A0	PREMIX START-UP PLUG GASKET	3.000	PC	GN1551A2	TORCH-CHAM BER SEALING	1.000	PC	GN1580B0	M8 TIE ROD GASKET	2.000	PC	GN1586B0	BAFFLE CHIMNEY	1.000	PC	RC1385B0	FLEXIBLE REVOLVING 1 GAS F-F FITTING	1.000	PC	VI0504A1	M4 SERRATED WASHER	6.000	PC	VI2009A2	GAS PIPE SCREW BRASS WASHER	3.000	PC	VI2020A0	M4x1 H4 CH 7 BRASS NUT	6.000	PC	KVG1091A	14kW TORCH+ P12-5 IGNITION PLUGS SET KIT	<table border="1"> <thead> <tr> <th>Code</th> <th>Description</th> <th>Qty</th> <th>UOM</th> </tr> </thead> <tbody> <tr> <td>BR1340A2</td> <td>PREMIX START-UP PLUG</td> <td>3.000</td> <td>PC</td> </tr> <tr> <td>BR1346D0</td> <td>14 KW GAS TORCH + PLATE</td> <td>1.000</td> <td>PC</td> </tr> <tr> <td>BR1361A0</td> <td>D14 REDUCTION PLATE</td> <td>1.000</td> <td>PC</td> </tr> <tr> <td>GN1542A0</td> <td>GAS PIPE 1"GAS FITTING ALLUMINIUM WASHER</td> <td>1.000</td> <td>PC</td> </tr> <tr> <td>GN1543A0</td> <td>PREMIX START-UP PLUG GASKET</td> <td>3.000</td> <td>PC</td> </tr> </tbody> </table>	Code	Description	Qty	UOM	BR1340A2	PREMIX START-UP PLUG	3.000	PC	BR1346D0	14 KW GAS TORCH + PLATE	1.000	PC	BR1361A0	D14 REDUCTION PLATE	1.000	PC	GN1542A0	GAS PIPE 1"GAS FITTING ALLUMINIUM WASHER	1.000	PC	GN1543A0	PREMIX START-UP PLUG GASKET	3.000	PC
			Code	Description	Qty	UOM																																																																														
BR1340A2	PREMIX START-UP PLUG	3.000	PC																																																																																	
BR1346D0	14 KW GAS TORCH + PLATE	1.000	PC																																																																																	
BR1361A0	D14 REDUCTION PLATE	1.000	PC																																																																																	
GN1542A0	GAS PIPE 1"GAS FITTING ALLUMINIUM WASHER	1.000	PC																																																																																	
GN1543A0	PREMIX START-UP PLUG GASKET	3.000	PC																																																																																	
GN1551A2	TORCH-CHAM BER SEALING	1.000	PC																																																																																	
GN1580B0	M8 TIE ROD GASKET	2.000	PC																																																																																	
GN1586B0	BAFFLE CHIMNEY	1.000	PC																																																																																	
RC1385B0	FLEXIBLE REVOLVING 1 GAS F-F FITTING	1.000	PC																																																																																	
VI0504A1	M4 SERRATED WASHER	6.000	PC																																																																																	
VI2009A2	GAS PIPE SCREW BRASS WASHER	3.000	PC																																																																																	
VI2020A0	M4x1 H4 CH 7 BRASS NUT	6.000	PC																																																																																	
Code	Description	Qty	UOM																																																																																	
BR1340A2	PREMIX START-UP PLUG	3.000	PC																																																																																	
BR1346D0	14 KW GAS TORCH + PLATE	1.000	PC																																																																																	
BR1361A0	D14 REDUCTION PLATE	1.000	PC																																																																																	
GN1542A0	GAS PIPE 1"GAS FITTING ALLUMINIUM WASHER	1.000	PC																																																																																	
GN1543A0	PREMIX START-UP PLUG GASKET	3.000	PC																																																																																	

COMPONENT			SPARE PART																																						
Code	Description	Image	Code	Description	Kit components																																				
BR1346D	14 KW GAS TORCH + PLATE		KVG1091A	14kW TORCH+ P12-5 IGNITION PLUGS SET KIT	<table border="1"> <thead> <tr> <th>Code</th> <th>Description</th> <th>Qty</th> <th>UOM</th> </tr> </thead> <tbody> <tr> <td>GN1551A2</td> <td>TORCH-CHAM BER SEALING</td> <td>1.000</td> <td>PC</td> </tr> <tr> <td>GN1580B0</td> <td>M8 TIE ROD GASKET</td> <td>2.000</td> <td>PC</td> </tr> <tr> <td>GN1586B0</td> <td>BAFFLE CHIMNEY</td> <td>1.000</td> <td>PC</td> </tr> <tr> <td>RC1385B0</td> <td>FLEXIBLE REVOLVING 1 GAS F-F FITTING</td> <td>1.000</td> <td>PC</td> </tr> <tr> <td>VI0504A1</td> <td>M4 SERRATED WASHER</td> <td>6.000</td> <td>PC</td> </tr> <tr> <td>VI2009A2</td> <td>GAS PIPE SCREW BRASS WASHER</td> <td>3.000</td> <td>PC</td> </tr> <tr> <td>VI2020A0</td> <td>M4x1 H4 CH 7 BRASS NUT</td> <td>6.000</td> <td>PC</td> </tr> </tbody> </table>	Code	Description	Qty	UOM	GN1551A2	TORCH-CHAM BER SEALING	1.000	PC	GN1580B0	M8 TIE ROD GASKET	2.000	PC	GN1586B0	BAFFLE CHIMNEY	1.000	PC	RC1385B0	FLEXIBLE REVOLVING 1 GAS F-F FITTING	1.000	PC	VI0504A1	M4 SERRATED WASHER	6.000	PC	VI2009A2	GAS PIPE SCREW BRASS WASHER	3.000	PC	VI2020A0	M4x1 H4 CH 7 BRASS NUT	6.000	PC				
					Code	Description	Qty	UOM																																	
					GN1551A2	TORCH-CHAM BER SEALING	1.000	PC																																	
					GN1580B0	M8 TIE ROD GASKET	2.000	PC																																	
					GN1586B0	BAFFLE CHIMNEY	1.000	PC																																	
					RC1385B0	FLEXIBLE REVOLVING 1 GAS F-F FITTING	1.000	PC																																	
					VI0504A1	M4 SERRATED WASHER	6.000	PC																																	
					VI2009A2	GAS PIPE SCREW BRASS WASHER	3.000	PC																																	
					VI2020A0	M4x1 H4 CH 7 BRASS NUT	6.000	PC																																	
BR1349A	BR1349A0		BR1349A0	BR1349A0																																					
GN1543A	PREMIX START-UP PLUG GASKET		KGN1569A	GAS TORCH SEALINGS KIT	<table border="1"> <thead> <tr> <th>Code</th> <th>Description</th> <th>Qty</th> <th>UOM</th> </tr> </thead> <tbody> <tr> <td>GN1541A0</td> <td>PREMIX BLOWER-SUP PORT GASKET</td> <td>2.000</td> <td>PC</td> </tr> <tr> <td>GN1542A0</td> <td>GAS PIPE 1"GAS FITTING ALLUMINIUM WASHER</td> <td>4.000</td> <td>PC</td> </tr> <tr> <td>GN1543A0</td> <td>PREMIX START-UP PLUG GASKET</td> <td>6.000</td> <td>PC</td> </tr> <tr> <td>GN1548A0</td> <td>"3/4" GAS PIPE ALLUMINIUM WASHER"</td> <td>4.000</td> <td>PC</td> </tr> <tr> <td>GN1551A2</td> <td>TORCH-CHAM BER SEALING</td> <td>2.000</td> <td>PC</td> </tr> <tr> <td>GN1559A0</td> <td>O-RING NBR 2087 21,95x1,7</td> <td>2.000</td> <td>PC</td> </tr> <tr> <td>GN1586A2</td> <td>TORCH LOWER SEALING</td> <td>2.000</td> <td>PC</td> </tr> <tr> <td>VI1521A0</td> <td>STAINLESS STEEL WASHER D=6 6592</td> <td>6.000</td> <td>PC</td> </tr> </tbody> </table>	Code	Description	Qty	UOM	GN1541A0	PREMIX BLOWER-SUP PORT GASKET	2.000	PC	GN1542A0	GAS PIPE 1"GAS FITTING ALLUMINIUM WASHER	4.000	PC	GN1543A0	PREMIX START-UP PLUG GASKET	6.000	PC	GN1548A0	"3/4" GAS PIPE ALLUMINIUM WASHER"	4.000	PC	GN1551A2	TORCH-CHAM BER SEALING	2.000	PC	GN1559A0	O-RING NBR 2087 21,95x1,7	2.000	PC	GN1586A2	TORCH LOWER SEALING	2.000	PC	VI1521A0	STAINLESS STEEL WASHER D=6 6592	6.000	PC
					Code	Description	Qty	UOM																																	
					GN1541A0	PREMIX BLOWER-SUP PORT GASKET	2.000	PC																																	
					GN1542A0	GAS PIPE 1"GAS FITTING ALLUMINIUM WASHER	4.000	PC																																	
					GN1543A0	PREMIX START-UP PLUG GASKET	6.000	PC																																	
					GN1548A0	"3/4" GAS PIPE ALLUMINIUM WASHER"	4.000	PC																																	
					GN1551A2	TORCH-CHAM BER SEALING	2.000	PC																																	
					GN1559A0	O-RING NBR 2087 21,95x1,7	2.000	PC																																	
					GN1586A2	TORCH LOWER SEALING	2.000	PC																																	
					VI1521A0	STAINLESS STEEL WASHER D=6 6592	6.000	PC																																	

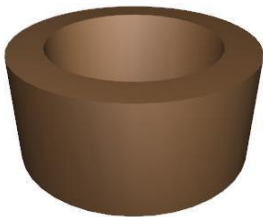

COMPONENT			SPARE PART																																																																													
Code	Description	Image	Code	Description	Kit components																																																																											
GN1580B	M8 TIE ROD GASKE		GN1580B0	M8 TIE ROD GASKE																																																																												
GN1586B	BAFFLE CHIMNEY		KVG1094A	14KW TORCH + P11 IGNITION PLUGS KI	<table border="1"> <thead> <tr> <th>Code</th> <th>Description</th> <th>Qty</th> <th>UOM</th> </tr> </thead> <tbody> <tr> <td>BR1340A2</td> <td>PREMIX START-UP PLUG</td> <td>3.000</td> <td>PC</td> </tr> <tr> <td>BR1346D0</td> <td>14 KW GAS TORCH + PLATE</td> <td>1.000</td> <td>PC</td> </tr> <tr> <td>BR1349A0</td> <td>BR1349A0</td> <td>1.000</td> <td>PC</td> </tr> <tr> <td>GN1542A0</td> <td>GAS PIPE 1"GAS FITTING ALLUMINIUM WASHER</td> <td>1.000</td> <td>PC</td> </tr> <tr> <td>GN1543A0</td> <td>PREMIX START-UP PLUG GASKET</td> <td>3.000</td> <td>PC</td> </tr> <tr> <td>GN1551A2</td> <td>TORCH-CHAM BER SEALING</td> <td>1.000</td> <td>PC</td> </tr> <tr> <td>GN1580B0</td> <td>M8 TIE ROD GASKET</td> <td>2.000</td> <td>PC</td> </tr> <tr> <td>GN1586B0</td> <td>BAFFLE CHIMNEY</td> <td>1.000</td> <td>PC</td> </tr> <tr> <td>RC1385B0</td> <td>FLEXIBLE REVOLVING 1 GAS F-F FITTING</td> <td>1.000</td> <td>PC</td> </tr> <tr> <td>VI0504A1</td> <td>M4 SERRATED WASHER</td> <td>6.000</td> <td>PC</td> </tr> <tr> <td>VI2009A2</td> <td>GAS PIPE SCREW BRASS WASHER</td> <td>3.000</td> <td>PC</td> </tr> <tr> <td>VI2020A0</td> <td>M4x1 H4 CH 7 BRASS NUT</td> <td>6.000</td> <td>PC</td> </tr> </tbody> </table>	Code	Description	Qty	UOM	BR1340A2	PREMIX START-UP PLUG	3.000	PC	BR1346D0	14 KW GAS TORCH + PLATE	1.000	PC	BR1349A0	BR1349A0	1.000	PC	GN1542A0	GAS PIPE 1"GAS FITTING ALLUMINIUM WASHER	1.000	PC	GN1543A0	PREMIX START-UP PLUG GASKET	3.000	PC	GN1551A2	TORCH-CHAM BER SEALING	1.000	PC	GN1580B0	M8 TIE ROD GASKET	2.000	PC	GN1586B0	BAFFLE CHIMNEY	1.000	PC	RC1385B0	FLEXIBLE REVOLVING 1 GAS F-F FITTING	1.000	PC	VI0504A1	M4 SERRATED WASHER	6.000	PC	VI2009A2	GAS PIPE SCREW BRASS WASHER	3.000	PC	VI2020A0	M4x1 H4 CH 7 BRASS NUT	6.000	PC	KVG1093A	25KW TORCH + P21 IGNITION PLUGS KI	<table border="1"> <thead> <tr> <th>Code</th> <th>Description</th> <th>Qty</th> <th>UOM</th> </tr> </thead> <tbody> <tr> <td>BR1347D0</td> <td></td> <td>1.000</td> <td>PC</td> </tr> <tr> <td>BR1375A1</td> <td>XEVL-2021-G START UP PLU</td> <td>3.000</td> <td>PC</td> </tr> <tr> <td>BR1378A0</td> <td></td> <td>1.000</td> <td>PC</td> </tr> <tr> <td>GN1542A0</td> <td>GAS PIPE 1"GAS FITTING ALLUMINIUM WASHER</td> <td>1.000</td> <td>PC</td> </tr> </tbody> </table>	Code	Description	Qty	UOM	BR1347D0		1.000	PC	BR1375A1	XEVL-2021-G START UP PLU	3.000	PC	BR1378A0		1.000	PC	GN1542A0	GAS PIPE 1"GAS FITTING ALLUMINIUM WASHER	1.000	PC
Code	Description	Qty	UOM																																																																													
BR1340A2	PREMIX START-UP PLUG	3.000	PC																																																																													
BR1346D0	14 KW GAS TORCH + PLATE	1.000	PC																																																																													
BR1349A0	BR1349A0	1.000	PC																																																																													
GN1542A0	GAS PIPE 1"GAS FITTING ALLUMINIUM WASHER	1.000	PC																																																																													
GN1543A0	PREMIX START-UP PLUG GASKET	3.000	PC																																																																													
GN1551A2	TORCH-CHAM BER SEALING	1.000	PC																																																																													
GN1580B0	M8 TIE ROD GASKET	2.000	PC																																																																													
GN1586B0	BAFFLE CHIMNEY	1.000	PC																																																																													
RC1385B0	FLEXIBLE REVOLVING 1 GAS F-F FITTING	1.000	PC																																																																													
VI0504A1	M4 SERRATED WASHER	6.000	PC																																																																													
VI2009A2	GAS PIPE SCREW BRASS WASHER	3.000	PC																																																																													
VI2020A0	M4x1 H4 CH 7 BRASS NUT	6.000	PC																																																																													
Code	Description	Qty	UOM																																																																													
BR1347D0		1.000	PC																																																																													
BR1375A1	XEVL-2021-G START UP PLU	3.000	PC																																																																													
BR1378A0		1.000	PC																																																																													
GN1542A0	GAS PIPE 1"GAS FITTING ALLUMINIUM WASHER	1.000	PC																																																																													

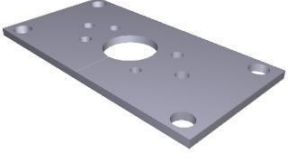

COMPONENT			SPARE PART																																											
Code	Description	Image	Code	Description	Kit components																																									
GN1586B	BAFFLE CHIMNEY		KVG1093A	25KW TORCH + P21 IGNITION PLUGS KI	<table border="1"> <thead> <tr> <th>Code</th> <th>Description</th> <th>Qty</th> <th>UOM</th> </tr> </thead> <tbody> <tr> <td>GN1551A2</td> <td>TORCH-CHAM BER SEALING</td> <td>1.000</td> <td>PC</td> </tr> <tr> <td>GN1580B0</td> <td>M8 TIE ROD GASKET</td> <td>2.000</td> <td>PC</td> </tr> <tr> <td>GN1586B0</td> <td>BAFFLE CHIMNEY</td> <td>1.000</td> <td>PC</td> </tr> <tr> <td>GN1594A0</td> <td>XEVL-2021-G M8 STUDS SEALING</td> <td>2.000</td> <td>PC</td> </tr> <tr> <td>GN1595A0</td> <td>ELECTROD BR1375 SEALING</td> <td>3.000</td> <td>PC</td> </tr> <tr> <td>RC1385B0</td> <td>FLEXIBLE REVOLVING 1 GAS F-F FITTING</td> <td>1.000</td> <td>PC</td> </tr> <tr> <td>VI0504A1</td> <td>M4 SERRATED WASHER</td> <td>6.000</td> <td>PC</td> </tr> <tr> <td>VI1114A0</td> <td>ELECTRODS M4 NUT</td> <td>6.000</td> <td>PC</td> </tr> <tr> <td>VI2009A2</td> <td>GAS PIPE SCREW BRASS WASHER</td> <td>3.000</td> <td>PC</td> </tr> </tbody> </table>	Code	Description	Qty	UOM	GN1551A2	TORCH-CHAM BER SEALING	1.000	PC	GN1580B0	M8 TIE ROD GASKET	2.000	PC	GN1586B0	BAFFLE CHIMNEY	1.000	PC	GN1594A0	XEVL-2021-G M8 STUDS SEALING	2.000	PC	GN1595A0	ELECTROD BR1375 SEALING	3.000	PC	RC1385B0	FLEXIBLE REVOLVING 1 GAS F-F FITTING	1.000	PC	VI0504A1	M4 SERRATED WASHER	6.000	PC	VI1114A0	ELECTRODS M4 NUT	6.000	PC	VI2009A2	GAS PIPE SCREW BRASS WASHER	3.000	PC	
			Code	Description	Qty	UOM																																								
GN1551A2	TORCH-CHAM BER SEALING	1.000	PC																																											
GN1580B0	M8 TIE ROD GASKET	2.000	PC																																											
GN1586B0	BAFFLE CHIMNEY	1.000	PC																																											
GN1594A0	XEVL-2021-G M8 STUDS SEALING	2.000	PC																																											
GN1595A0	ELECTROD BR1375 SEALING	3.000	PC																																											
RC1385B0	FLEXIBLE REVOLVING 1 GAS F-F FITTING	1.000	PC																																											
VI0504A1	M4 SERRATED WASHER	6.000	PC																																											
VI1114A0	ELECTRODS M4 NUT	6.000	PC																																											
VI2009A2	GAS PIPE SCREW BRASS WASHER	3.000	PC																																											
KVG1092A	14kW TORCH+ P 14 IGNITION PLUGS SET KIT	<table border="1"> <thead> <tr> <th>Code</th> <th>Description</th> <th>Qty</th> <th>UOM</th> </tr> </thead> <tbody> <tr> <td>BR1340A2</td> <td>PREMIX START-UP PLUG</td> <td>3.000</td> <td>PC</td> </tr> <tr> <td>BR1346D0</td> <td>14 KW GAS TORCH + PLATE</td> <td>1.000</td> <td>PC</td> </tr> <tr> <td>BR1361A0</td> <td>D14 REDUCTION PLATE</td> <td>1.000</td> <td>PC</td> </tr> <tr> <td>GN1542A0</td> <td>GAS PIPE 1"GAS FITTING ALLUMINIUM WASHER</td> <td>1.000</td> <td>PC</td> </tr> <tr> <td>GN1543A0</td> <td>PREMIX START-UP PLUG GASKET</td> <td>3.000</td> <td>PC</td> </tr> <tr> <td>GN1551A2</td> <td>TORCH-CHAM BER SEALING</td> <td>1.000</td> <td>PC</td> </tr> <tr> <td>GN1580B0</td> <td>M8 TIE ROD GASKET</td> <td>2.000</td> <td>PC</td> </tr> <tr> <td>GN1586B0</td> <td>BAFFLE CHIMNEY</td> <td>1.000</td> <td>PC</td> </tr> <tr> <td>RC1385B0</td> <td>FLEXIBLE REVOLVING 1 GAS F-F FITTING</td> <td>1.000</td> <td>PC</td> </tr> <tr> <td>VI0504A1</td> <td>M4 SERRATED WASHER</td> <td>6.000</td> <td>PC</td> </tr> </tbody> </table>	Code	Description	Qty	UOM	BR1340A2	PREMIX START-UP PLUG	3.000	PC	BR1346D0	14 KW GAS TORCH + PLATE	1.000	PC	BR1361A0	D14 REDUCTION PLATE	1.000	PC	GN1542A0	GAS PIPE 1"GAS FITTING ALLUMINIUM WASHER	1.000	PC	GN1543A0	PREMIX START-UP PLUG GASKET	3.000	PC	GN1551A2	TORCH-CHAM BER SEALING	1.000	PC	GN1580B0	M8 TIE ROD GASKET	2.000	PC	GN1586B0	BAFFLE CHIMNEY	1.000	PC	RC1385B0	FLEXIBLE REVOLVING 1 GAS F-F FITTING	1.000	PC	VI0504A1	M4 SERRATED WASHER	6.000	PC
Code	Description	Qty	UOM																																											
BR1340A2	PREMIX START-UP PLUG	3.000	PC																																											
BR1346D0	14 KW GAS TORCH + PLATE	1.000	PC																																											
BR1361A0	D14 REDUCTION PLATE	1.000	PC																																											
GN1542A0	GAS PIPE 1"GAS FITTING ALLUMINIUM WASHER	1.000	PC																																											
GN1543A0	PREMIX START-UP PLUG GASKET	3.000	PC																																											
GN1551A2	TORCH-CHAM BER SEALING	1.000	PC																																											
GN1580B0	M8 TIE ROD GASKET	2.000	PC																																											
GN1586B0	BAFFLE CHIMNEY	1.000	PC																																											
RC1385B0	FLEXIBLE REVOLVING 1 GAS F-F FITTING	1.000	PC																																											
VI0504A1	M4 SERRATED WASHER	6.000	PC																																											

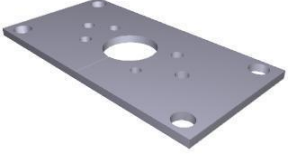

COMPONENT			SPARE PART																																																			
Code	Description	Image	Code	Description	Kit components																																																	
GN1586B	BAFFLE CHIMNEY		KVG1092A	14kW TORCH+ P 14 IGNITION PLUGS SET KIT	<table border="1"> <thead> <tr> <th>Code</th> <th>Description</th> <th>Qty</th> <th>UOM</th> </tr> </thead> <tbody> <tr> <td>VI2009A2</td> <td>GAS PIPE SCREW BRASS WASHER</td> <td>3.000</td> <td>PC</td> </tr> <tr> <td>VI2020A0</td> <td>M4x1 H4 CH 7 BRASS NUT</td> <td>6.000</td> <td>PC</td> </tr> </tbody> </table>	Code	Description	Qty	UOM	VI2009A2	GAS PIPE SCREW BRASS WASHER	3.000	PC	VI2020A0	M4x1 H4 CH 7 BRASS NUT	6.000	PC																																					
			Code	Description	Qty	UOM																																																
			VI2009A2	GAS PIPE SCREW BRASS WASHER	3.000	PC																																																
VI2020A0	M4x1 H4 CH 7 BRASS NUT	6.000	PC																																																			
KVG1091A	14kW TORCH+ P12-5 IGNITION PLUGS SET KIT	<table border="1"> <thead> <tr> <th>Code</th> <th>Description</th> <th>Qty</th> <th>UOM</th> </tr> </thead> <tbody> <tr> <td>BR1340A2</td> <td>PREMIX START-UP PLUG</td> <td>3.000</td> <td>PC</td> </tr> <tr> <td>BR1346D0</td> <td>14 KW GAS TORCH + PLATE</td> <td>1.000</td> <td>PC</td> </tr> <tr> <td>BR1361A0</td> <td>D14 REDUCTION PLATE</td> <td>1.000</td> <td>PC</td> </tr> <tr> <td>GN1542A0</td> <td>GAS PIPE 1"GAS FITTING ALLUMINIUM WASHER</td> <td>1.000</td> <td>PC</td> </tr> <tr> <td>GN1543A0</td> <td>PREMIX START-UP PLUG GASKET</td> <td>3.000</td> <td>PC</td> </tr> <tr> <td>GN1551A2</td> <td>TORCH-CHAM BER SEALING</td> <td>1.000</td> <td>PC</td> </tr> <tr> <td>GN1580B0</td> <td>M8 TIE ROD GASKET</td> <td>2.000</td> <td>PC</td> </tr> <tr> <td>GN1586B0</td> <td>BAFFLE CHIMNEY</td> <td>1.000</td> <td>PC</td> </tr> <tr> <td>RC1385B0</td> <td>FLEXIBLE REVOLVING 1 GAS F-F FITTING</td> <td>1.000</td> <td>PC</td> </tr> <tr> <td>VI0504A1</td> <td>M4 SERRATED WASHER</td> <td>6.000</td> <td>PC</td> </tr> <tr> <td>VI2009A2</td> <td>GAS PIPE SCREW BRASS WASHER</td> <td>3.000</td> <td>PC</td> </tr> <tr> <td>VI2020A0</td> <td>M4x1 H4 CH 7 BRASS NUT</td> <td>6.000</td> <td>PC</td> </tr> </tbody> </table>	Code	Description	Qty	UOM	BR1340A2	PREMIX START-UP PLUG	3.000	PC	BR1346D0	14 KW GAS TORCH + PLATE	1.000	PC	BR1361A0	D14 REDUCTION PLATE	1.000	PC	GN1542A0	GAS PIPE 1"GAS FITTING ALLUMINIUM WASHER	1.000	PC	GN1543A0	PREMIX START-UP PLUG GASKET	3.000	PC	GN1551A2	TORCH-CHAM BER SEALING	1.000	PC	GN1580B0	M8 TIE ROD GASKET	2.000	PC	GN1586B0	BAFFLE CHIMNEY	1.000	PC	RC1385B0	FLEXIBLE REVOLVING 1 GAS F-F FITTING	1.000	PC	VI0504A1	M4 SERRATED WASHER	6.000	PC	VI2009A2	GAS PIPE SCREW BRASS WASHER	3.000	PC	VI2020A0	M4x1 H4 CH 7 BRASS NUT	6.000	PC
Code	Description	Qty	UOM																																																			
BR1340A2	PREMIX START-UP PLUG	3.000	PC																																																			
BR1346D0	14 KW GAS TORCH + PLATE	1.000	PC																																																			
BR1361A0	D14 REDUCTION PLATE	1.000	PC																																																			
GN1542A0	GAS PIPE 1"GAS FITTING ALLUMINIUM WASHER	1.000	PC																																																			
GN1543A0	PREMIX START-UP PLUG GASKET	3.000	PC																																																			
GN1551A2	TORCH-CHAM BER SEALING	1.000	PC																																																			
GN1580B0	M8 TIE ROD GASKET	2.000	PC																																																			
GN1586B0	BAFFLE CHIMNEY	1.000	PC																																																			
RC1385B0	FLEXIBLE REVOLVING 1 GAS F-F FITTING	1.000	PC																																																			
VI0504A1	M4 SERRATED WASHER	6.000	PC																																																			
VI2009A2	GAS PIPE SCREW BRASS WASHER	3.000	PC																																																			
VI2020A0	M4x1 H4 CH 7 BRASS NUT	6.000	PC																																																			
KVG1090A	9.5kW TORCH+ P9.5 IGNITION PLUGS SET KIT	<table border="1"> <thead> <tr> <th>Code</th> <th>Description</th> <th>Qty</th> <th>UOM</th> </tr> </thead> <tbody> <tr> <td>BR1340A2</td> <td>PREMIX START-UP PLUG</td> <td>3.000</td> <td>PC</td> </tr> <tr> <td>BR1345D0</td> <td>9.5 KW BURNE</td> <td>1.000</td> <td>PC</td> </tr> <tr> <td>BR1365A0</td> <td>REDUCTION, PLATE D11</td> <td>1.000</td> <td>PC</td> </tr> </tbody> </table>	Code	Description	Qty	UOM	BR1340A2	PREMIX START-UP PLUG	3.000	PC	BR1345D0	9.5 KW BURNE	1.000	PC	BR1365A0	REDUCTION, PLATE D11	1.000	PC																																				
Code	Description	Qty	UOM																																																			
BR1340A2	PREMIX START-UP PLUG	3.000	PC																																																			
BR1345D0	9.5 KW BURNE	1.000	PC																																																			
BR1365A0	REDUCTION, PLATE D11	1.000	PC																																																			

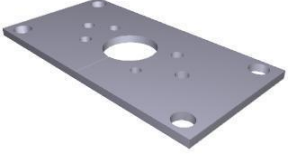

COMPONENT			SPARE PART																																										
Code	Description	Image	Code	Description	Kit components																																								
GN1586B	BAFFLE CHIMNEY		KVG1090A	9.5kW TORCH+ P9.5 IGNITION PLUGS SET KIT	<table border="1"> <thead> <tr> <th>Code</th> <th>Description</th> <th>Qty</th> <th>UOM</th> </tr> </thead> <tbody> <tr> <td>GN1542A0</td> <td>GAS PIPE 1"GAS FITTING ALLUMINIUM WASHER</td> <td>1.000</td> <td>PC</td> </tr> <tr> <td>GN1543A0</td> <td>PREMIX START-UP PLUG GASKET</td> <td>3.000</td> <td>PC</td> </tr> <tr> <td>GN1551A2</td> <td>TORCH-CHAM BER SEALING</td> <td>1.000</td> <td>PC</td> </tr> <tr> <td>GN1580B0</td> <td>M8 TIE ROD GASKET</td> <td>2.000</td> <td>PC</td> </tr> <tr> <td>GN1586B0</td> <td>BAFFLE CHIMNEY</td> <td>1.000</td> <td>PC</td> </tr> <tr> <td>RC1385B0</td> <td>FLEXIBLE REVOLVING 1 GAS F-F FITTING</td> <td>1.000</td> <td>PC</td> </tr> <tr> <td>VI0504A1</td> <td>M4 SERRATED WASHER</td> <td>6.000</td> <td>PC</td> </tr> <tr> <td>VI2009A2</td> <td>GAS PIPE SCREW BRASS WASHER</td> <td>3.000</td> <td>PC</td> </tr> <tr> <td>VI2020A0</td> <td>M4x1 H4 CH 7 BRASS NUT</td> <td>6.000</td> <td>PC</td> </tr> </tbody> </table>	Code	Description	Qty	UOM	GN1542A0	GAS PIPE 1"GAS FITTING ALLUMINIUM WASHER	1.000	PC	GN1543A0	PREMIX START-UP PLUG GASKET	3.000	PC	GN1551A2	TORCH-CHAM BER SEALING	1.000	PC	GN1580B0	M8 TIE ROD GASKET	2.000	PC	GN1586B0	BAFFLE CHIMNEY	1.000	PC	RC1385B0	FLEXIBLE REVOLVING 1 GAS F-F FITTING	1.000	PC	VI0504A1	M4 SERRATED WASHER	6.000	PC	VI2009A2	GAS PIPE SCREW BRASS WASHER	3.000	PC	VI2020A0	M4x1 H4 CH 7 BRASS NUT	6.000	PC
			Code	Description	Qty	UOM																																							
			GN1542A0	GAS PIPE 1"GAS FITTING ALLUMINIUM WASHER	1.000	PC																																							
GN1543A0	PREMIX START-UP PLUG GASKET	3.000	PC																																										
GN1551A2	TORCH-CHAM BER SEALING	1.000	PC																																										
GN1580B0	M8 TIE ROD GASKET	2.000	PC																																										
GN1586B0	BAFFLE CHIMNEY	1.000	PC																																										
RC1385B0	FLEXIBLE REVOLVING 1 GAS F-F FITTING	1.000	PC																																										
VI0504A1	M4 SERRATED WASHER	6.000	PC																																										
VI2009A2	GAS PIPE SCREW BRASS WASHER	3.000	PC																																										
VI2020A0	M4x1 H4 CH 7 BRASS NUT	6.000	PC																																										
KVG1056A	L 2021 45KW RIGHT TORCH+IGNIT PLUGS KIT	<table border="1"> <thead> <tr> <th>Code</th> <th>Description</th> <th>Qty</th> <th>UOM</th> </tr> </thead> <tbody> <tr> <td>BR1371A0</td> <td>35KW RIGHT RAMP + TORCH SET</td> <td>1.000</td> <td>PC</td> </tr> <tr> <td>BR1375A1</td> <td>XEVL-2021-G START UP PLU</td> <td>3.000</td> <td>PC</td> </tr> <tr> <td>GN1586B0</td> <td>BAFFLE CHIMNEY</td> <td>1.000</td> <td>PC</td> </tr> <tr> <td>GN1594A0</td> <td>XEVL-2021-G M8 STUDS SEALING</td> <td>2.000</td> <td>PC</td> </tr> <tr> <td>GN1595A0</td> <td>ELECTROD BR1375 SEALING</td> <td>3.000</td> <td>PC</td> </tr> <tr> <td>VI0504A1</td> <td>M4 SERRATED WASHER</td> <td>6.000</td> <td>PC</td> </tr> <tr> <td>VI1114A0</td> <td>ELECTRODS M4 NUT</td> <td>6.000</td> <td>PC</td> </tr> </tbody> </table>	Code	Description	Qty	UOM	BR1371A0	35KW RIGHT RAMP + TORCH SET	1.000	PC	BR1375A1	XEVL-2021-G START UP PLU	3.000	PC	GN1586B0	BAFFLE CHIMNEY	1.000	PC	GN1594A0	XEVL-2021-G M8 STUDS SEALING	2.000	PC	GN1595A0	ELECTROD BR1375 SEALING	3.000	PC	VI0504A1	M4 SERRATED WASHER	6.000	PC	VI1114A0	ELECTRODS M4 NUT	6.000	PC											
Code	Description	Qty	UOM																																										
BR1371A0	35KW RIGHT RAMP + TORCH SET	1.000	PC																																										
BR1375A1	XEVL-2021-G START UP PLU	3.000	PC																																										
GN1586B0	BAFFLE CHIMNEY	1.000	PC																																										
GN1594A0	XEVL-2021-G M8 STUDS SEALING	2.000	PC																																										
GN1595A0	ELECTROD BR1375 SEALING	3.000	PC																																										
VI0504A1	M4 SERRATED WASHER	6.000	PC																																										
VI1114A0	ELECTRODS M4 NUT	6.000	PC																																										
KVG1055A	L 2021 45KW LEFT TORCH+IGNIT PLUGS KIT	<table border="1"> <thead> <tr> <th>Code</th> <th>Description</th> <th>Qty</th> <th>UOM</th> </tr> </thead> <tbody> <tr> <td>BR1369A0</td> <td>35KW LEFT RAMP + TORCH SET</td> <td>1.000</td> <td>PC</td> </tr> <tr> <td>BR1375A1</td> <td>XEVL-2021-G START UP PLU</td> <td>3.000</td> <td>PC</td> </tr> <tr> <td>GN1586B0</td> <td>BAFFLE CHIMNEY</td> <td>1.000</td> <td>PC</td> </tr> </tbody> </table>	Code	Description	Qty	UOM	BR1369A0	35KW LEFT RAMP + TORCH SET	1.000	PC	BR1375A1	XEVL-2021-G START UP PLU	3.000	PC	GN1586B0	BAFFLE CHIMNEY	1.000	PC																											
Code	Description	Qty	UOM																																										
BR1369A0	35KW LEFT RAMP + TORCH SET	1.000	PC																																										
BR1375A1	XEVL-2021-G START UP PLU	3.000	PC																																										
GN1586B0	BAFFLE CHIMNEY	1.000	PC																																										



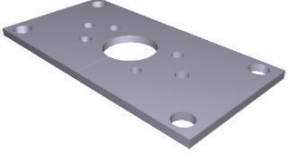

COMPONENT			SPARE PART																																		
Code	Description	Image	Code	Description	Kit components																																
GN1586B	BAFFLE CHIMNEY		KVG1055A	L 2021 45KW LEFT TORCH+IGNIT PLUGS KIT	<table border="1"> <thead> <tr> <th>Code</th> <th>Description</th> <th>Qty</th> <th>UOM</th> </tr> </thead> <tbody> <tr> <td>GN1594A0</td> <td>XEVL-2021-G M8 STUDS SEALING</td> <td>2.000</td> <td>PC</td> </tr> <tr> <td>GN1595A0</td> <td>ELECTROD BR1375 SEALING</td> <td>3.000</td> <td>PC</td> </tr> <tr> <td>VI1114A0</td> <td>ELECTRODS M4 NUT</td> <td>6.000</td> <td>PC</td> </tr> </tbody> </table>	Code	Description	Qty	UOM	GN1594A0	XEVL-2021-G M8 STUDS SEALING	2.000	PC	GN1595A0	ELECTROD BR1375 SEALING	3.000	PC	VI1114A0	ELECTRODS M4 NUT	6.000	PC																
			Code	Description	Qty	UOM																															
			GN1594A0	XEVL-2021-G M8 STUDS SEALING	2.000	PC																															
			GN1595A0	ELECTROD BR1375 SEALING	3.000	PC																															
			VI1114A0	ELECTRODS M4 NUT	6.000	PC																															
			KVG1051A	BIG-L 24KW RIGHT TORCH+IGNIT PLUGS KIT	<table border="1"> <thead> <tr> <th>Code</th> <th>Description</th> <th>Qty</th> <th>UOM</th> </tr> </thead> <tbody> <tr> <td>BR1340A2</td> <td>PREMIX START-UP PLUG</td> <td>3.000</td> <td>PC</td> </tr> <tr> <td>BR1368A0</td> <td>22KW RIGHT RAMP + TORCH SET</td> <td>1.000</td> <td>PC</td> </tr> <tr> <td>GN1543A0</td> <td>PREMIX START-UP PLUG GASKET</td> <td>3.000</td> <td>PC</td> </tr> <tr> <td>GN1580B0</td> <td>M8 TIE ROD GASKET</td> <td>2.000</td> <td>PC</td> </tr> <tr> <td>GN1586B0</td> <td>BAFFLE CHIMNEY</td> <td>1.000</td> <td>PC</td> </tr> <tr> <td>VI0504A1</td> <td>M4 SERRATED WASHER</td> <td>6.000</td> <td>PC</td> </tr> <tr> <td>VI2020A0</td> <td>M4x1 H4 CH 7 BRASS NUT</td> <td>6.000</td> <td>PC</td> </tr> </tbody> </table>	Code	Description	Qty	UOM	BR1340A2	PREMIX START-UP PLUG	3.000	PC	BR1368A0	22KW RIGHT RAMP + TORCH SET	1.000	PC	GN1543A0	PREMIX START-UP PLUG GASKET	3.000	PC	GN1580B0	M8 TIE ROD GASKET	2.000	PC	GN1586B0	BAFFLE CHIMNEY	1.000	PC	VI0504A1	M4 SERRATED WASHER	6.000	PC	VI2020A0	M4x1 H4 CH 7 BRASS NUT	6.000	PC
			Code	Description	Qty	UOM																															
			BR1340A2	PREMIX START-UP PLUG	3.000	PC																															
			BR1368A0	22KW RIGHT RAMP + TORCH SET	1.000	PC																															
			GN1543A0	PREMIX START-UP PLUG GASKET	3.000	PC																															
GN1580B0	M8 TIE ROD GASKET	2.000	PC																																		
GN1586B0	BAFFLE CHIMNEY	1.000	PC																																		
VI0504A1	M4 SERRATED WASHER	6.000	PC																																		
VI2020A0	M4x1 H4 CH 7 BRASS NUT	6.000	PC																																		
KVG1050A	24KW LEFT TORCH+IGNITION PLUGS KIT BIG-L	<table border="1"> <thead> <tr> <th>Code</th> <th>Description</th> <th>Qty</th> <th>UOM</th> </tr> </thead> <tbody> <tr> <td>BR1340A2</td> <td>PREMIX START-UP PLUG</td> <td>3.000</td> <td>PC</td> </tr> <tr> <td>BR1367A0</td> <td>22KW LEFT RAMP + TORCH SET</td> <td>1.000</td> <td>PC</td> </tr> <tr> <td>GN1543A0</td> <td>PREMIX START-UP PLUG GASKET</td> <td>3.000</td> <td>PC</td> </tr> <tr> <td>GN1580B0</td> <td>M8 TIE ROD GASKET</td> <td>2.000</td> <td>PC</td> </tr> <tr> <td>GN1586B0</td> <td>BAFFLE CHIMNEY</td> <td>1.000</td> <td>PC</td> </tr> <tr> <td>VI0504A1</td> <td>M4 SERRATED WASHER</td> <td>6.000</td> <td>PC</td> </tr> <tr> <td>VI2020A0</td> <td>M4x1 H4 CH 7 BRASS NUT</td> <td>6.000</td> <td>PC</td> </tr> </tbody> </table>	Code	Description	Qty	UOM	BR1340A2	PREMIX START-UP PLUG	3.000	PC	BR1367A0	22KW LEFT RAMP + TORCH SET	1.000	PC	GN1543A0	PREMIX START-UP PLUG GASKET	3.000	PC	GN1580B0	M8 TIE ROD GASKET	2.000	PC	GN1586B0	BAFFLE CHIMNEY	1.000	PC	VI0504A1	M4 SERRATED WASHER	6.000	PC	VI2020A0	M4x1 H4 CH 7 BRASS NUT	6.000	PC			
Code	Description	Qty	UOM																																		
BR1340A2	PREMIX START-UP PLUG	3.000	PC																																		
BR1367A0	22KW LEFT RAMP + TORCH SET	1.000	PC																																		
GN1543A0	PREMIX START-UP PLUG GASKET	3.000	PC																																		
GN1580B0	M8 TIE ROD GASKET	2.000	PC																																		
GN1586B0	BAFFLE CHIMNEY	1.000	PC																																		
VI0504A1	M4 SERRATED WASHER	6.000	PC																																		
VI2020A0	M4x1 H4 CH 7 BRASS NUT	6.000	PC																																		
KVG1044C	35KW TORCH+IGNITION PLUGS KIT	<table border="1"> <thead> <tr> <th>Code</th> <th>Description</th> <th>Qty</th> <th>UOM</th> </tr> </thead> <tbody> <tr> <td>BR1340A2</td> <td>PREMIX START-UP PLUG</td> <td>3.000</td> <td>PC</td> </tr> <tr> <td>BR1347C0</td> <td></td> <td>1.000</td> <td>PC</td> </tr> <tr> <td>BR1360A0</td> <td>TORCH SILENCER GAP h 43</td> <td>1.000</td> <td>PC</td> </tr> </tbody> </table>	Code	Description	Qty	UOM	BR1340A2	PREMIX START-UP PLUG	3.000	PC	BR1347C0		1.000	PC	BR1360A0	TORCH SILENCER GAP h 43	1.000	PC																			
Code	Description	Qty	UOM																																		
BR1340A2	PREMIX START-UP PLUG	3.000	PC																																		
BR1347C0		1.000	PC																																		
BR1360A0	TORCH SILENCER GAP h 43	1.000	PC																																		





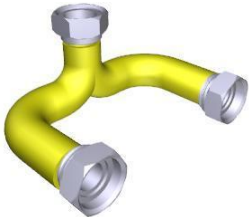
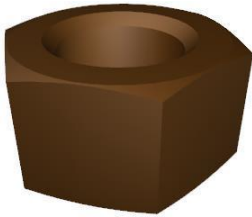

COMPONENT			SPARE PART																																										
Code	Description	Image	Code	Description	Kit components																																								
GN1586B	BAFFLE CHIMNEY		KVG1044C	35KW TORCH+IGNITION PLUGS KIT	<table border="1"> <thead> <tr> <th>Code</th> <th>Description</th> <th>Qty</th> <th>UOM</th> </tr> </thead> <tbody> <tr> <td>GN1542A0</td> <td>GAS PIPE 1"GAS FITTING ALLUMINIUM WASHER</td> <td>1.000</td> <td>PC</td> </tr> <tr> <td>GN1543A0</td> <td>PREMIX START-UP PLUG GASKET</td> <td>3.000</td> <td>PC</td> </tr> <tr> <td>GN1551A2</td> <td>TORCH-CHAM BER SEALING</td> <td>1.000</td> <td>PC</td> </tr> <tr> <td>GN1580B0</td> <td>M8 TIE ROD GASKET</td> <td>2.000</td> <td>PC</td> </tr> <tr> <td>GN1586B0</td> <td>BAFFLE CHIMNEY</td> <td>1.000</td> <td>PC</td> </tr> <tr> <td>RC1385B0</td> <td>FLEXIBLE REVOLVING 1 GAS F-F FITTING</td> <td>1.000</td> <td>PC</td> </tr> <tr> <td>VI0504A1</td> <td>M4 SERRATED WASHER</td> <td>6.000</td> <td>PC</td> </tr> <tr> <td>VI2009A2</td> <td>GAS PIPE SCREW BRASS WASHER</td> <td>3.000</td> <td>PC</td> </tr> <tr> <td>VI2020A0</td> <td>M4x1 H4 CH 7 BRASS NUT</td> <td>6.000</td> <td>PC</td> </tr> </tbody> </table>	Code	Description	Qty	UOM	GN1542A0	GAS PIPE 1"GAS FITTING ALLUMINIUM WASHER	1.000	PC	GN1543A0	PREMIX START-UP PLUG GASKET	3.000	PC	GN1551A2	TORCH-CHAM BER SEALING	1.000	PC	GN1580B0	M8 TIE ROD GASKET	2.000	PC	GN1586B0	BAFFLE CHIMNEY	1.000	PC	RC1385B0	FLEXIBLE REVOLVING 1 GAS F-F FITTING	1.000	PC	VI0504A1	M4 SERRATED WASHER	6.000	PC	VI2009A2	GAS PIPE SCREW BRASS WASHER	3.000	PC	VI2020A0	M4x1 H4 CH 7 BRASS NUT	6.000	PC
			Code	Description	Qty	UOM																																							
GN1542A0	GAS PIPE 1"GAS FITTING ALLUMINIUM WASHER	1.000	PC																																										
GN1543A0	PREMIX START-UP PLUG GASKET	3.000	PC																																										
GN1551A2	TORCH-CHAM BER SEALING	1.000	PC																																										
GN1580B0	M8 TIE ROD GASKET	2.000	PC																																										
GN1586B0	BAFFLE CHIMNEY	1.000	PC																																										
RC1385B0	FLEXIBLE REVOLVING 1 GAS F-F FITTING	1.000	PC																																										
VI0504A1	M4 SERRATED WASHER	6.000	PC																																										
VI2009A2	GAS PIPE SCREW BRASS WASHER	3.000	PC																																										
VI2020A0	M4x1 H4 CH 7 BRASS NUT	6.000	PC																																										
KG1569A	GAS TORCH SEALINGS KIT	<table border="1"> <thead> <tr> <th>Code</th> <th>Description</th> <th>Qty</th> <th>UOM</th> </tr> </thead> <tbody> <tr> <td>GN1541A0</td> <td>PREMIX BLOWER-SUP PORT GASKET</td> <td>2.000</td> <td>PC</td> </tr> <tr> <td>GN1542A0</td> <td>GAS PIPE 1"GAS FITTING ALLUMINIUM WASHER</td> <td>4.000</td> <td>PC</td> </tr> <tr> <td>GN1543A0</td> <td>PREMIX START-UP PLUG GASKET</td> <td>6.000</td> <td>PC</td> </tr> <tr> <td>GN1548A0</td> <td>"3/4" GAS PIPE ALLUMINIUM WASHER"</td> <td>4.000</td> <td>PC</td> </tr> <tr> <td>GN1551A2</td> <td>TORCH-CHAM BER SEALING</td> <td>2.000</td> <td>PC</td> </tr> <tr> <td>GN1559A0</td> <td>O-RING NBR 2087 21,95x1,7</td> <td>2.000</td> <td>PC</td> </tr> <tr> <td>GN1586A2</td> <td>TORCH LOWER SEALING</td> <td>2.000</td> <td>PC</td> </tr> <tr> <td>VI1521A0</td> <td>STAINLESS STEEL WASHER D=6 6592</td> <td>6.000</td> <td>PC</td> </tr> </tbody> </table>	Code	Description	Qty	UOM	GN1541A0	PREMIX BLOWER-SUP PORT GASKET	2.000	PC	GN1542A0	GAS PIPE 1"GAS FITTING ALLUMINIUM WASHER	4.000	PC	GN1543A0	PREMIX START-UP PLUG GASKET	6.000	PC	GN1548A0	"3/4" GAS PIPE ALLUMINIUM WASHER"	4.000	PC	GN1551A2	TORCH-CHAM BER SEALING	2.000	PC	GN1559A0	O-RING NBR 2087 21,95x1,7	2.000	PC	GN1586A2	TORCH LOWER SEALING	2.000	PC	VI1521A0	STAINLESS STEEL WASHER D=6 6592	6.000	PC							
Code	Description	Qty	UOM																																										
GN1541A0	PREMIX BLOWER-SUP PORT GASKET	2.000	PC																																										
GN1542A0	GAS PIPE 1"GAS FITTING ALLUMINIUM WASHER	4.000	PC																																										
GN1543A0	PREMIX START-UP PLUG GASKET	6.000	PC																																										
GN1548A0	"3/4" GAS PIPE ALLUMINIUM WASHER"	4.000	PC																																										
GN1551A2	TORCH-CHAM BER SEALING	2.000	PC																																										
GN1559A0	O-RING NBR 2087 21,95x1,7	2.000	PC																																										
GN1586A2	TORCH LOWER SEALING	2.000	PC																																										
VI1521A0	STAINLESS STEEL WASHER D=6 6592	6.000	PC																																										



COMPONENT			SPARE PART																																		
Code	Description	Image	Code	Description	Kit components																																
GN1586B	BAFFLE CHIMNEY		KBR1375A	BIG-L 2021 PREMIX START UP PLUG 6PCS KIT	<table border="1"> <thead> <tr> <th>Code</th> <th>Description</th> <th>Qty</th> <th>UOM</th> </tr> </thead> <tbody> <tr> <td>BR1375A1</td> <td>XEVL-2021-G START UP PLU</td> <td>6.000</td> <td>PC</td> </tr> <tr> <td>GN1551A2</td> <td>TORCH-CHAMBER SEALING</td> <td>2.000</td> <td>PC</td> </tr> <tr> <td>GN1586B0</td> <td>BAFFLE CHIMNEY</td> <td>2.000</td> <td>PC</td> </tr> <tr> <td>GN1594A0</td> <td>XEVL-2021-G M8 STUDS SEALING</td> <td>4.000</td> <td>PC</td> </tr> <tr> <td>GN1595A0</td> <td>ELECTROD BR1375 SEALING</td> <td>6.000</td> <td>PC</td> </tr> <tr> <td>VI0504A1</td> <td>M4 SERRATED WASHER</td> <td>12.000</td> <td>PC</td> </tr> <tr> <td>VI1114A0</td> <td>ELECTRODS M4 NUT</td> <td>12.000</td> <td>PC</td> </tr> </tbody> </table>	Code	Description	Qty	UOM	BR1375A1	XEVL-2021-G START UP PLU	6.000	PC	GN1551A2	TORCH-CHAMBER SEALING	2.000	PC	GN1586B0	BAFFLE CHIMNEY	2.000	PC	GN1594A0	XEVL-2021-G M8 STUDS SEALING	4.000	PC	GN1595A0	ELECTROD BR1375 SEALING	6.000	PC	VI0504A1	M4 SERRATED WASHER	12.000	PC	VI1114A0	ELECTRODS M4 NUT	12.000	PC
Code	Description	Qty	UOM																																		
BR1375A1	XEVL-2021-G START UP PLU	6.000	PC																																		
GN1551A2	TORCH-CHAMBER SEALING	2.000	PC																																		
GN1586B0	BAFFLE CHIMNEY	2.000	PC																																		
GN1594A0	XEVL-2021-G M8 STUDS SEALING	4.000	PC																																		
GN1595A0	ELECTROD BR1375 SEALING	6.000	PC																																		
VI0504A1	M4 SERRATED WASHER	12.000	PC																																		
VI1114A0	ELECTRODS M4 NUT	12.000	PC																																		
RC1385B	FLEXIBLE REVOLVING 1 GAS F-F FITTING		KRC1385B	FLEXIBLE REVOLVING GAS CONNECTION KIT	<table border="1"> <thead> <tr> <th>Code</th> <th>Description</th> <th>Qty</th> <th>UOM</th> </tr> </thead> <tbody> <tr> <td>GN1542A0</td> <td>GAS PIPE 1"GAS FITTING ALLUMINIUM WASHER</td> <td>1.000</td> <td>PC</td> </tr> <tr> <td>RC1385B0</td> <td>FLEXIBLE REVOLVING 1 GAS F-F FITTING</td> <td>1.000</td> <td>PC</td> </tr> </tbody> </table>	Code	Description	Qty	UOM	GN1542A0	GAS PIPE 1"GAS FITTING ALLUMINIUM WASHER	1.000	PC	RC1385B0	FLEXIBLE REVOLVING 1 GAS F-F FITTING	1.000	PC																				
Code	Description	Qty	UOM																																		
GN1542A0	GAS PIPE 1"GAS FITTING ALLUMINIUM WASHER	1.000	PC																																		
RC1385B0	FLEXIBLE REVOLVING 1 GAS F-F FITTING	1.000	PC																																		
VI2020A	M4x1 H4 CH 7 BRASS NUT		VI2020A0	M4x1 H4 CH 7 BRASS NUT																																	
VI2021A	M5X0.8 H5 CH 8 BRASS NUT		VI2021A0	M5X0.8 H5 CH 8 BRASS NUT																																	

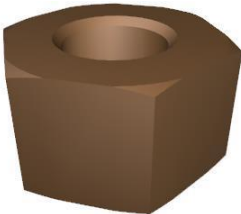
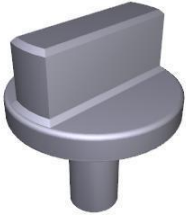

COMPONENT			SPARE PART										
Code	Description	Image	Code	Description	Kit components								
VM2388A	PREMIX BLOWER PROTECTION		OUTOFPRODUCTIO	ITEM OUT OF PRODUCTION									
VI1555A	Ø6 ST. STEEL SCHNOOR KNURLED WASHER		VI1555A0	Ø6 ST. STEEL SCHNOOR KNURLED WASHER									
VI2018A	M6x1 H6 CH10 BRASS NUT		VI2018A0	M6x1 H6 CH10 BRASS NUT									
VM1820A	LATERAL SUPPORTS M6 FIXING BOLT		KVM1820A	THUMB SCREW 10PCS KIT	<table border="1"> <thead> <tr> <th>Code</th> <th>Description</th> <th>Qty</th> <th>UOM</th> </tr> </thead> <tbody> <tr> <td>VM1820A0</td> <td>LATERAL SUPPORTS M6 FIXING BOLT</td> <td>10.000</td> <td>PC</td> </tr> </tbody> </table>	Code	Description	Qty	UOM	VM1820A0	LATERAL SUPPORTS M6 FIXING BOLT	10.000	PC
Code	Description	Qty	UOM										
VM1820A0	LATERAL SUPPORTS M6 FIXING BOLT	10.000	PC										
VM2331A	FAN GUARD-TRAYS HOLDER PIN		KVM2331A	FAN GUARD-TRAYS HOLDER PIN 4 PCS KIT	<table border="1"> <thead> <tr> <th>Code</th> <th>Description</th> <th>Qty</th> <th>UOM</th> </tr> </thead> <tbody> <tr> <td>VM2331A0</td> <td>FAN GUARD-TRAYS HOLDER PIN</td> <td>4.000</td> <td>PC</td> </tr> </tbody> </table>	Code	Description	Qty	UOM	VM2331A0	FAN GUARD-TRAYS HOLDER PIN	4.000	PC
Code	Description	Qty	UOM										
VM2331A0	FAN GUARD-TRAYS HOLDER PIN	4.000	PC										







ASM4045C/0.D04 - External cover - FRONT







ASM4045C/0.D04 - External cover - REAR







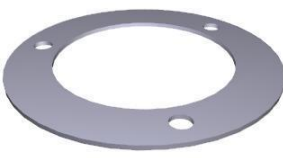

COMPONENT			SPARE PART		
Code	Description	Image	Code	Description	Kit components
0D2303A	XEVC-1011 LEFT SIDE PANEL		0D2303A2	XEVC-1011 LEFT SIDE PANEL	
0D2304A	XEVC-1011 EXTERNAL RIGHT SIDE		0D2304A2	XEVC-1011 EXTERNAL RIGHT SIDE	
0D2340A	XEVC GAS BACK COVER		0D2340A1	XEVC GAS BACK COVER	
0E1349A	0E1349A0		0E1349A0	0E1349A0	
0E1364C	0E1364C3		OUTOFPRODUCTIO	ITEM OUT OF PRODUCTION	

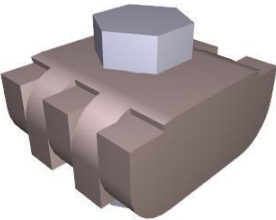

COMPONENT			SPARE PART		
Code	Description	Image	Code	Description	Kit components
0F1502A	BACK PANEL XEVC-1011-G		0F1502A0	BACK PANEL XEVC-1011-G	
0H7232B	0H7232B3		OUTOFPRODUCTIO	ITEM OUT OF PRODUCTION	
0H7458A	GAS FITTING FIXING PLATE		0H7458A0	GAS FITTING FIXING PLATE	
0H7459A	GAS CHIMNEY EXCHANGES GASKET HOLDER		0H7459A0	GAS CHIMNEY EXCHANGES GASKET HOLDER	
0H7473A	GAS CHEFTOP REINFORCEMENT BAR		0H7473A1	GAS CHEFTOP REINFORCEMENT BAR	



COMPONENT			SPARE PART																						
Code	Description	Image	Code	Description	Kit components																				
VM1750A	BRASS COMB CLAM		KVM1750A	COMB TERMINAL BLOCK KIT	<table border="1"> <thead> <tr> <th>Code</th> <th>Description</th> <th>Qty</th> <th>UOM</th> </tr> </thead> <tbody> <tr> <td>VI1040A0</td> <td>INDENTED INTERNAL WASHER D=6 ZN</td> <td>2.000</td> <td>PC</td> </tr> <tr> <td>VM1750A0</td> <td>BRASS COMB CLAMP</td> <td>1.000</td> <td>PC</td> </tr> </tbody> </table>	Code	Description	Qty	UOM	VI1040A0	INDENTED INTERNAL WASHER D=6 ZN	2.000	PC	VM1750A0	BRASS COMB CLAMP	1.000	PC								
Code	Description	Qty	UOM																						
VI1040A0	INDENTED INTERNAL WASHER D=6 ZN	2.000	PC																						
VM1750A0	BRASS COMB CLAMP	1.000	PC																						
VM1630A	INTERNAL GLASS PUSHING CAP		KVM1630A	CAP FOR INTERNAL GLASS 10 PCS KIT	<table border="1"> <thead> <tr> <th>Code</th> <th>Description</th> <th>Qty</th> <th>UOM</th> </tr> </thead> <tbody> <tr> <td>VM1630A1</td> <td>INTERNAL GLASS PUSHING CAP</td> <td>10.000</td> <td>PC</td> </tr> </tbody> </table>	Code	Description	Qty	UOM	VM1630A1	INTERNAL GLASS PUSHING CAP	10.000	PC												
Code	Description	Qty	UOM																						
VM1630A1	INTERNAL GLASS PUSHING CAP	10.000	PC																						
VM2280B	HANDLE LATCH PLATE COVER		KVM2280B	VM2280B -M HANDLE LATCH PLATE COVER KIT	<table border="1"> <thead> <tr> <th>Code</th> <th>Description</th> <th>Qty</th> <th>UOM</th> </tr> </thead> <tbody> <tr> <td>VI1074A0</td> <td>4X16 SCREW FOR PLASTIC</td> <td>2.000</td> <td>PC</td> </tr> <tr> <td>VM1630A1</td> <td>INTERNAL GLASS PUSHING CAP</td> <td>2.000</td> <td>PC</td> </tr> <tr> <td>VM2280B0</td> <td>HANDLE LATCH PLATE COVER</td> <td>1.000</td> <td>PC</td> </tr> </tbody> </table>	Code	Description	Qty	UOM	VI1074A0	4X16 SCREW FOR PLASTIC	2.000	PC	VM1630A1	INTERNAL GLASS PUSHING CAP	2.000	PC	VM2280B0	HANDLE LATCH PLATE COVER	1.000	PC				
Code	Description	Qty	UOM																						
VI1074A0	4X16 SCREW FOR PLASTIC	2.000	PC																						
VM1630A1	INTERNAL GLASS PUSHING CAP	2.000	PC																						
VM2280B0	HANDLE LATCH PLATE COVER	1.000	PC																						
VP1530A	BT CT RIGHT HANDLE LATCH		KVM1190A	CHEFTOP/BAKERTO P DOOR RIGHT LATCH KIT	<table border="1"> <thead> <tr> <th>Code</th> <th>Description</th> <th>Qty</th> <th>UOM</th> </tr> </thead> <tbody> <tr> <td>VI1074A0</td> <td>4X16 SCREW FOR PLASTIC</td> <td>2.000</td> <td>PC</td> </tr> <tr> <td>VI1220A1</td> <td>4,2x12 TCB SELF-TAPPING SCREW</td> <td>2.000</td> <td>PC</td> </tr> <tr> <td>VM1460A0</td> <td>XBC/XVC RIGHT DOOR LATCH CAP</td> <td>1.000</td> <td>PC</td> </tr> <tr> <td>VP1530A0</td> <td>BT CT RIGHT HANDLE LATC</td> <td>1.000</td> <td>PC</td> </tr> </tbody> </table>	Code	Description	Qty	UOM	VI1074A0	4X16 SCREW FOR PLASTIC	2.000	PC	VI1220A1	4,2x12 TCB SELF-TAPPING SCREW	2.000	PC	VM1460A0	XBC/XVC RIGHT DOOR LATCH CAP	1.000	PC	VP1530A0	BT CT RIGHT HANDLE LATC	1.000	PC
Code	Description	Qty	UOM																						
VI1074A0	4X16 SCREW FOR PLASTIC	2.000	PC																						
VI1220A1	4,2x12 TCB SELF-TAPPING SCREW	2.000	PC																						
VM1460A0	XBC/XVC RIGHT DOOR LATCH CAP	1.000	PC																						
VP1530A0	BT CT RIGHT HANDLE LATC	1.000	PC																						
VM1190A	CT BT RIGHT DOOR SPRING LATCH		KVM1190A	CHEFTOP/BAKERTO P DOOR RIGHT LATCH KIT	<table border="1"> <thead> <tr> <th>Code</th> <th>Description</th> <th>Qty</th> <th>UOM</th> </tr> </thead> <tbody> <tr> <td>VI1074A0</td> <td>4X16 SCREW FOR PLASTIC</td> <td>2.000</td> <td>PC</td> </tr> <tr> <td>VI1220A1</td> <td>4,2x12 TCB SELF-TAPPING SCREW</td> <td>2.000</td> <td>PC</td> </tr> <tr> <td>VM1460A0</td> <td>XBC/XVC RIGHT DOOR LATCH CAP</td> <td>1.000</td> <td>PC</td> </tr> <tr> <td>VP1530A0</td> <td>BT CT RIGHT HANDLE LATC</td> <td>1.000</td> <td>PC</td> </tr> </tbody> </table>	Code	Description	Qty	UOM	VI1074A0	4X16 SCREW FOR PLASTIC	2.000	PC	VI1220A1	4,2x12 TCB SELF-TAPPING SCREW	2.000	PC	VM1460A0	XBC/XVC RIGHT DOOR LATCH CAP	1.000	PC	VP1530A0	BT CT RIGHT HANDLE LATC	1.000	PC
Code	Description	Qty	UOM																						
VI1074A0	4X16 SCREW FOR PLASTIC	2.000	PC																						
VI1220A1	4,2x12 TCB SELF-TAPPING SCREW	2.000	PC																						
VM1460A0	XBC/XVC RIGHT DOOR LATCH CAP	1.000	PC																						
VP1530A0	BT CT RIGHT HANDLE LATC	1.000	PC																						



COMPONENT			SPARE PART																						
Code	Description	Image	Code	Description	Kit components																				
VM1192A	CT BT DOOR SPRING LATCH BACK COVER		KVM1191A	CHEFTOP/BAKERTO P DOOR LEFT LATCH KIT	<table border="1"> <thead> <tr> <th>Code</th> <th>Description</th> <th>Qty</th> <th>UOM</th> </tr> </thead> <tbody> <tr> <td>VI1074A0</td> <td>4X16 SCREW FOR PLASTIC</td> <td>2.000</td> <td>PC</td> </tr> <tr> <td>VI1220A1</td> <td>4,2x12 TCB SELF-TAPPIN G SCREW</td> <td>2.000</td> <td>PC</td> </tr> <tr> <td>VM1460A0</td> <td>XBC/XVC RIGHT DOOR LATCH CAP</td> <td>1.000</td> <td>PC</td> </tr> <tr> <td>VP1531A0</td> <td>BT CT LEFT HANDLE LATC</td> <td>1.000</td> <td>PC</td> </tr> </tbody> </table>	Code	Description	Qty	UOM	VI1074A0	4X16 SCREW FOR PLASTIC	2.000	PC	VI1220A1	4,2x12 TCB SELF-TAPPIN G SCREW	2.000	PC	VM1460A0	XBC/XVC RIGHT DOOR LATCH CAP	1.000	PC	VP1531A0	BT CT LEFT HANDLE LATC	1.000	PC
			Code	Description	Qty	UOM																			
VI1074A0	4X16 SCREW FOR PLASTIC	2.000	PC																						
VI1220A1	4,2x12 TCB SELF-TAPPIN G SCREW	2.000	PC																						
VM1460A0	XBC/XVC RIGHT DOOR LATCH CAP	1.000	PC																						
VP1531A0	BT CT LEFT HANDLE LATC	1.000	PC																						
KVM1190A	CHEFTOP/BAKERTO P DOOR RIGHT LATCH KIT	<table border="1"> <thead> <tr> <th>Code</th> <th>Description</th> <th>Qty</th> <th>UOM</th> </tr> </thead> <tbody> <tr> <td>VI1074A0</td> <td>4X16 SCREW FOR PLASTIC</td> <td>2.000</td> <td>PC</td> </tr> <tr> <td>VI1220A1</td> <td>4,2x12 TCB SELF-TAPPIN G SCREW</td> <td>2.000</td> <td>PC</td> </tr> <tr> <td>VM1460A0</td> <td>XBC/XVC RIGHT DOOR LATCH CAP</td> <td>1.000</td> <td>PC</td> </tr> <tr> <td>VP1530A0</td> <td>BT CT RIGHT HANDLE LATC</td> <td>1.000</td> <td>PC</td> </tr> </tbody> </table>	Code	Description	Qty	UOM	VI1074A0	4X16 SCREW FOR PLASTIC	2.000	PC	VI1220A1	4,2x12 TCB SELF-TAPPIN G SCREW	2.000	PC	VM1460A0	XBC/XVC RIGHT DOOR LATCH CAP	1.000	PC	VP1530A0	BT CT RIGHT HANDLE LATC	1.000	PC			
Code	Description	Qty	UOM																						
VI1074A0	4X16 SCREW FOR PLASTIC	2.000	PC																						
VI1220A1	4,2x12 TCB SELF-TAPPIN G SCREW	2.000	PC																						
VM1460A0	XBC/XVC RIGHT DOOR LATCH CAP	1.000	PC																						
VP1530A0	BT CT RIGHT HANDLE LATC	1.000	PC																						
VM2281A	DOOR LATCH HOLES COVER		KVM2281A	HOLE PLATE COVER KIT	<table border="1"> <thead> <tr> <th>Code</th> <th>Description</th> <th>Qty</th> <th>UOM</th> </tr> </thead> <tbody> <tr> <td>VM2281A0</td> <td>DOOR LATCH HOLES COVER</td> <td>1.000</td> <td>PC</td> </tr> </tbody> </table>	Code	Description	Qty	UOM	VM2281A0	DOOR LATCH HOLES COVER	1.000	PC												
Code	Description	Qty	UOM																						
VM2281A0	DOOR LATCH HOLES COVER	1.000	PC																						
VP1531A	BT CT LEFT HANDLE LATCH		KVM1191A	CHEFTOP/BAKERTO P DOOR LEFT LATCH KIT	<table border="1"> <thead> <tr> <th>Code</th> <th>Description</th> <th>Qty</th> <th>UOM</th> </tr> </thead> <tbody> <tr> <td>VI1074A0</td> <td>4X16 SCREW FOR PLASTIC</td> <td>2.000</td> <td>PC</td> </tr> <tr> <td>VI1220A1</td> <td>4,2x12 TCB SELF-TAPPIN G SCREW</td> <td>2.000</td> <td>PC</td> </tr> <tr> <td>VM1460A0</td> <td>XBC/XVC RIGHT DOOR LATCH CAP</td> <td>1.000</td> <td>PC</td> </tr> <tr> <td>VP1531A0</td> <td>BT CT LEFT HANDLE LATC</td> <td>1.000</td> <td>PC</td> </tr> </tbody> </table>	Code	Description	Qty	UOM	VI1074A0	4X16 SCREW FOR PLASTIC	2.000	PC	VI1220A1	4,2x12 TCB SELF-TAPPIN G SCREW	2.000	PC	VM1460A0	XBC/XVC RIGHT DOOR LATCH CAP	1.000	PC	VP1531A0	BT CT LEFT HANDLE LATC	1.000	PC
					Code	Description	Qty	UOM																	
					VI1074A0	4X16 SCREW FOR PLASTIC	2.000	PC																	
					VI1220A1	4,2x12 TCB SELF-TAPPIN G SCREW	2.000	PC																	
VM1460A0	XBC/XVC RIGHT DOOR LATCH CAP	1.000	PC																						
VP1531A0	BT CT LEFT HANDLE LATC	1.000	PC																						



COMPONENT			SPARE PART																						
Code	Description	Image	Code	Description	Kit components																				
VM1191A	CT BT LEFT DOOR SPRING LATCH		KVM1191A	CHEFTOP/BAKERTO P DOOR LEFT LATCH KIT	<table border="1"> <thead> <tr> <th>Code</th> <th>Description</th> <th>Qty</th> <th>UOM</th> </tr> </thead> <tbody> <tr> <td>VI1074A0</td> <td>4X16 SCREW FOR PLASTIC</td> <td>2.000</td> <td>PC</td> </tr> <tr> <td>VI1220A1</td> <td>4,2x12 TCB SELF-TAPPIN G SCREW</td> <td>2.000</td> <td>PC</td> </tr> <tr> <td>VM1460A0</td> <td>XBC/XVC RIGHT DOOR LATCH CAP</td> <td>1.000</td> <td>PC</td> </tr> <tr> <td>VP1531A0</td> <td>BT CT LEFT HANDLE LATC</td> <td>1.000</td> <td>PC</td> </tr> </tbody> </table>	Code	Description	Qty	UOM	VI1074A0	4X16 SCREW FOR PLASTIC	2.000	PC	VI1220A1	4,2x12 TCB SELF-TAPPIN G SCREW	2.000	PC	VM1460A0	XBC/XVC RIGHT DOOR LATCH CAP	1.000	PC	VP1531A0	BT CT LEFT HANDLE LATC	1.000	PC
					Code	Description	Qty	UOM																	
					VI1074A0	4X16 SCREW FOR PLASTIC	2.000	PC																	
					VI1220A1	4,2x12 TCB SELF-TAPPIN G SCREW	2.000	PC																	
VM1460A0	XBC/XVC RIGHT DOOR LATCH CAP	1.000	PC																						
VP1531A0	BT CT LEFT HANDLE LATC	1.000	PC																						
<table border="1"> <thead> <tr> <th>Code</th> <th>Description</th> <th>Qty</th> <th>UOM</th> </tr> </thead> <tbody> <tr> <td>VI1074A0</td> <td>4X16 SCREW FOR PLASTIC</td> <td>2.000</td> <td>PC</td> </tr> <tr> <td>VI1220A1</td> <td>4,2x12 TCB SELF-TAPPIN G SCREW</td> <td>2.000</td> <td>PC</td> </tr> <tr> <td>VM1460A0</td> <td>XBC/XVC RIGHT DOOR LATCH CAP</td> <td>1.000</td> <td>PC</td> </tr> <tr> <td>VP1531A0</td> <td>BT CT LEFT HANDLE LATC</td> <td>1.000</td> <td>PC</td> </tr> </tbody> </table>	Code	Description	Qty	UOM	VI1074A0	4X16 SCREW FOR PLASTIC	2.000	PC	VI1220A1	4,2x12 TCB SELF-TAPPIN G SCREW	2.000	PC	VM1460A0	XBC/XVC RIGHT DOOR LATCH CAP	1.000	PC	VP1531A0	BT CT LEFT HANDLE LATC	1.000	PC					
Code	Description	Qty	UOM																						
VI1074A0	4X16 SCREW FOR PLASTIC	2.000	PC																						
VI1220A1	4,2x12 TCB SELF-TAPPIN G SCREW	2.000	PC																						
VM1460A0	XBC/XVC RIGHT DOOR LATCH CAP	1.000	PC																						
VP1531A0	BT CT LEFT HANDLE LATC	1.000	PC																						
<table border="1"> <thead> <tr> <th>Code</th> <th>Description</th> <th>Qty</th> <th>UOM</th> </tr> </thead> <tbody> <tr> <td>VI1074A0</td> <td>4X16 SCREW FOR PLASTIC</td> <td>2.000</td> <td>PC</td> </tr> <tr> <td>VI1220A1</td> <td>4,2x12 TCB SELF-TAPPIN G SCREW</td> <td>2.000</td> <td>PC</td> </tr> <tr> <td>VM1460A0</td> <td>XBC/XVC RIGHT DOOR LATCH CAP</td> <td>1.000</td> <td>PC</td> </tr> <tr> <td>VP1531A0</td> <td>BT CT LEFT HANDLE LATC</td> <td>1.000</td> <td>PC</td> </tr> </tbody> </table>	Code	Description	Qty	UOM	VI1074A0	4X16 SCREW FOR PLASTIC	2.000	PC	VI1220A1	4,2x12 TCB SELF-TAPPIN G SCREW	2.000	PC	VM1460A0	XBC/XVC RIGHT DOOR LATCH CAP	1.000	PC	VP1531A0	BT CT LEFT HANDLE LATC	1.000	PC					
Code	Description	Qty	UOM																						
VI1074A0	4X16 SCREW FOR PLASTIC	2.000	PC																						
VI1220A1	4,2x12 TCB SELF-TAPPIN G SCREW	2.000	PC																						
VM1460A0	XBC/XVC RIGHT DOOR LATCH CAP	1.000	PC																						
VP1531A0	BT CT LEFT HANDLE LATC	1.000	PC																						
<table border="1"> <thead> <tr> <th>Code</th> <th>Description</th> <th>Qty</th> <th>UOM</th> </tr> </thead> <tbody> <tr> <td>VI1074A0</td> <td>4X16 SCREW FOR PLASTIC</td> <td>2.000</td> <td>PC</td> </tr> <tr> <td>VI1220A1</td> <td>4,2x12 TCB SELF-TAPPIN G SCREW</td> <td>2.000</td> <td>PC</td> </tr> <tr> <td>VM1460A0</td> <td>XBC/XVC RIGHT DOOR LATCH CAP</td> <td>1.000</td> <td>PC</td> </tr> <tr> <td>VP1531A0</td> <td>BT CT LEFT HANDLE LATC</td> <td>1.000</td> <td>PC</td> </tr> </tbody> </table>	Code	Description	Qty	UOM	VI1074A0	4X16 SCREW FOR PLASTIC	2.000	PC	VI1220A1	4,2x12 TCB SELF-TAPPIN G SCREW	2.000	PC	VM1460A0	XBC/XVC RIGHT DOOR LATCH CAP	1.000	PC	VP1531A0	BT CT LEFT HANDLE LATC	1.000	PC					
Code	Description	Qty	UOM																						
VI1074A0	4X16 SCREW FOR PLASTIC	2.000	PC																						
VI1220A1	4,2x12 TCB SELF-TAPPIN G SCREW	2.000	PC																						
VM1460A0	XBC/XVC RIGHT DOOR LATCH CAP	1.000	PC																						
VP1531A0	BT CT LEFT HANDLE LATC	1.000	PC																						
VM1192A	CT BT DOOR SPRING LATCH BACK COVER		KVM1191A	CHEFTOP/BAKERTO P DOOR LEFT LATCH KIT	<table border="1"> <thead> <tr> <th>Code</th> <th>Description</th> <th>Qty</th> <th>UOM</th> </tr> </thead> <tbody> <tr> <td>VI1074A0</td> <td>4X16 SCREW FOR PLASTIC</td> <td>2.000</td> <td>PC</td> </tr> <tr> <td>VI1220A1</td> <td>4,2x12 TCB SELF-TAPPIN G SCREW</td> <td>2.000</td> <td>PC</td> </tr> <tr> <td>VM1460A0</td> <td>XBC/XVC RIGHT DOOR LATCH CAP</td> <td>1.000</td> <td>PC</td> </tr> <tr> <td>VP1531A0</td> <td>BT CT LEFT HANDLE LATC</td> <td>1.000</td> <td>PC</td> </tr> </tbody> </table>	Code	Description	Qty	UOM	VI1074A0	4X16 SCREW FOR PLASTIC	2.000	PC	VI1220A1	4,2x12 TCB SELF-TAPPIN G SCREW	2.000	PC	VM1460A0	XBC/XVC RIGHT DOOR LATCH CAP	1.000	PC	VP1531A0	BT CT LEFT HANDLE LATC	1.000	PC
					Code	Description	Qty	UOM																	
					VI1074A0	4X16 SCREW FOR PLASTIC	2.000	PC																	
					VI1220A1	4,2x12 TCB SELF-TAPPIN G SCREW	2.000	PC																	
VM1460A0	XBC/XVC RIGHT DOOR LATCH CAP	1.000	PC																						
VP1531A0	BT CT LEFT HANDLE LATC	1.000	PC																						
<table border="1"> <thead> <tr> <th>Code</th> <th>Description</th> <th>Qty</th> <th>UOM</th> </tr> </thead> <tbody> <tr> <td>VI1074A0</td> <td>4X16 SCREW FOR PLASTIC</td> <td>2.000</td> <td>PC</td> </tr> <tr> <td>VI1220A1</td> <td>4,2x12 TCB SELF-TAPPIN G SCREW</td> <td>2.000</td> <td>PC</td> </tr> <tr> <td>VM1460A0</td> <td>XBC/XVC RIGHT DOOR LATCH CAP</td> <td>1.000</td> <td>PC</td> </tr> <tr> <td>VP1531A0</td> <td>BT CT LEFT HANDLE LATC</td> <td>1.000</td> <td>PC</td> </tr> </tbody> </table>	Code	Description	Qty	UOM	VI1074A0	4X16 SCREW FOR PLASTIC	2.000	PC	VI1220A1	4,2x12 TCB SELF-TAPPIN G SCREW	2.000	PC	VM1460A0	XBC/XVC RIGHT DOOR LATCH CAP	1.000	PC	VP1531A0	BT CT LEFT HANDLE LATC	1.000	PC					
Code	Description	Qty	UOM																						
VI1074A0	4X16 SCREW FOR PLASTIC	2.000	PC																						
VI1220A1	4,2x12 TCB SELF-TAPPIN G SCREW	2.000	PC																						
VM1460A0	XBC/XVC RIGHT DOOR LATCH CAP	1.000	PC																						
VP1531A0	BT CT LEFT HANDLE LATC	1.000	PC																						
<table border="1"> <thead> <tr> <th>Code</th> <th>Description</th> <th>Qty</th> <th>UOM</th> </tr> </thead> <tbody> <tr> <td>VI1074A0</td> <td>4X16 SCREW FOR PLASTIC</td> <td>2.000</td> <td>PC</td> </tr> <tr> <td>VI1220A1</td> <td>4,2x12 TCB SELF-TAPPIN G SCREW</td> <td>2.000</td> <td>PC</td> </tr> <tr> <td>VM1460A0</td> <td>XBC/XVC RIGHT DOOR LATCH CAP</td> <td>1.000</td> <td>PC</td> </tr> <tr> <td>VP1531A0</td> <td>BT CT LEFT HANDLE LATC</td> <td>1.000</td> <td>PC</td> </tr> </tbody> </table>	Code	Description	Qty	UOM	VI1074A0	4X16 SCREW FOR PLASTIC	2.000	PC	VI1220A1	4,2x12 TCB SELF-TAPPIN G SCREW	2.000	PC	VM1460A0	XBC/XVC RIGHT DOOR LATCH CAP	1.000	PC	VP1531A0	BT CT LEFT HANDLE LATC	1.000	PC					
Code	Description	Qty	UOM																						
VI1074A0	4X16 SCREW FOR PLASTIC	2.000	PC																						
VI1220A1	4,2x12 TCB SELF-TAPPIN G SCREW	2.000	PC																						
VM1460A0	XBC/XVC RIGHT DOOR LATCH CAP	1.000	PC																						
VP1531A0	BT CT LEFT HANDLE LATC	1.000	PC																						
<table border="1"> <thead> <tr> <th>Code</th> <th>Description</th> <th>Qty</th> <th>UOM</th> </tr> </thead> <tbody> <tr> <td>VI1074A0</td> <td>4X16 SCREW FOR PLASTIC</td> <td>2.000</td> <td>PC</td> </tr> <tr> <td>VI1220A1</td> <td>4,2x12 TCB SELF-TAPPIN G SCREW</td> <td>2.000</td> <td>PC</td> </tr> <tr> <td>VM1460A0</td> <td>XBC/XVC RIGHT DOOR LATCH CAP</td> <td>1.000</td> <td>PC</td> </tr> <tr> <td>VP1531A0</td> <td>BT CT LEFT HANDLE LATC</td> <td>1.000</td> <td>PC</td> </tr> </tbody> </table>	Code	Description	Qty	UOM	VI1074A0	4X16 SCREW FOR PLASTIC	2.000	PC	VI1220A1	4,2x12 TCB SELF-TAPPIN G SCREW	2.000	PC	VM1460A0	XBC/XVC RIGHT DOOR LATCH CAP	1.000	PC	VP1531A0	BT CT LEFT HANDLE LATC	1.000	PC					
Code	Description	Qty	UOM																						
VI1074A0	4X16 SCREW FOR PLASTIC	2.000	PC																						
VI1220A1	4,2x12 TCB SELF-TAPPIN G SCREW	2.000	PC																						
VM1460A0	XBC/XVC RIGHT DOOR LATCH CAP	1.000	PC																						
VP1531A0	BT CT LEFT HANDLE LATC	1.000	PC																						
KVM1190A			KVM1190A	CHEFTOP/BAKERTO P DOOR RIGHT LATCH KIT	<table border="1"> <thead> <tr> <th>Code</th> <th>Description</th> <th>Qty</th> <th>UOM</th> </tr> </thead> <tbody> <tr> <td>VI1074A0</td> <td>4X16 SCREW FOR PLASTIC</td> <td>2.000</td> <td>PC</td> </tr> <tr> <td>VI1220A1</td> <td>4,2x12 TCB SELF-TAPPIN G SCREW</td> <td>2.000</td> <td>PC</td> </tr> <tr> <td>VM1460A0</td> <td>XBC/XVC RIGHT DOOR LATCH CAP</td> <td>1.000</td> <td>PC</td> </tr> <tr> <td>VP1530A0</td> <td>BT CT RIGHT HANDLE LATC</td> <td>1.000</td> <td>PC</td> </tr> </tbody> </table>	Code	Description	Qty	UOM	VI1074A0	4X16 SCREW FOR PLASTIC	2.000	PC	VI1220A1	4,2x12 TCB SELF-TAPPIN G SCREW	2.000	PC	VM1460A0	XBC/XVC RIGHT DOOR LATCH CAP	1.000	PC	VP1530A0	BT CT RIGHT HANDLE LATC	1.000	PC
					Code	Description	Qty	UOM																	
					VI1074A0	4X16 SCREW FOR PLASTIC	2.000	PC																	
					VI1220A1	4,2x12 TCB SELF-TAPPIN G SCREW	2.000	PC																	
VM1460A0	XBC/XVC RIGHT DOOR LATCH CAP	1.000	PC																						
VP1530A0	BT CT RIGHT HANDLE LATC	1.000	PC																						
<table border="1"> <thead> <tr> <th>Code</th> <th>Description</th> <th>Qty</th> <th>UOM</th> </tr> </thead> <tbody> <tr> <td>VI1074A0</td> <td>4X16 SCREW FOR PLASTIC</td> <td>2.000</td> <td>PC</td> </tr> <tr> <td>VI1220A1</td> <td>4,2x12 TCB SELF-TAPPIN G SCREW</td> <td>2.000</td> <td>PC</td> </tr> <tr> <td>VM1460A0</td> <td>XBC/XVC RIGHT DOOR LATCH CAP</td> <td>1.000</td> <td>PC</td> </tr> <tr> <td>VP1530A0</td> <td>BT CT RIGHT HANDLE LATC</td> <td>1.000</td> <td>PC</td> </tr> </tbody> </table>	Code	Description	Qty	UOM	VI1074A0	4X16 SCREW FOR PLASTIC	2.000	PC	VI1220A1	4,2x12 TCB SELF-TAPPIN G SCREW	2.000	PC	VM1460A0	XBC/XVC RIGHT DOOR LATCH CAP	1.000	PC	VP1530A0	BT CT RIGHT HANDLE LATC	1.000	PC					
Code	Description	Qty	UOM																						
VI1074A0	4X16 SCREW FOR PLASTIC	2.000	PC																						
VI1220A1	4,2x12 TCB SELF-TAPPIN G SCREW	2.000	PC																						
VM1460A0	XBC/XVC RIGHT DOOR LATCH CAP	1.000	PC																						
VP1530A0	BT CT RIGHT HANDLE LATC	1.000	PC																						
<table border="1"> <thead> <tr> <th>Code</th> <th>Description</th> <th>Qty</th> <th>UOM</th> </tr> </thead> <tbody> <tr> <td>VI1074A0</td> <td>4X16 SCREW FOR PLASTIC</td> <td>2.000</td> <td>PC</td> </tr> <tr> <td>VI1220A1</td> <td>4,2x12 TCB SELF-TAPPIN G SCREW</td> <td>2.000</td> <td>PC</td> </tr> <tr> <td>VM1460A0</td> <td>XBC/XVC RIGHT DOOR LATCH CAP</td> <td>1.000</td> <td>PC</td> </tr> <tr> <td>VP1530A0</td> <td>BT CT RIGHT HANDLE LATC</td> <td>1.000</td> <td>PC</td> </tr> </tbody> </table>	Code	Description	Qty	UOM	VI1074A0	4X16 SCREW FOR PLASTIC	2.000	PC	VI1220A1	4,2x12 TCB SELF-TAPPIN G SCREW	2.000	PC	VM1460A0	XBC/XVC RIGHT DOOR LATCH CAP	1.000	PC	VP1530A0	BT CT RIGHT HANDLE LATC	1.000	PC					
Code	Description	Qty	UOM																						
VI1074A0	4X16 SCREW FOR PLASTIC	2.000	PC																						
VI1220A1	4,2x12 TCB SELF-TAPPIN G SCREW	2.000	PC																						
VM1460A0	XBC/XVC RIGHT DOOR LATCH CAP	1.000	PC																						
VP1530A0	BT CT RIGHT HANDLE LATC	1.000	PC																						
<table border="1"> <thead> <tr> <th>Code</th> <th>Description</th> <th>Qty</th> <th>UOM</th> </tr> </thead> <tbody> <tr> <td>VI1074A0</td> <td>4X16 SCREW FOR PLASTIC</td> <td>2.000</td> <td>PC</td> </tr> <tr> <td>VI1220A1</td> <td>4,2x12 TCB SELF-TAPPIN G SCREW</td> <td>2.000</td> <td>PC</td> </tr> <tr> <td>VM1460A0</td> <td>XBC/XVC RIGHT DOOR LATCH CAP</td> <td>1.000</td> <td>PC</td> </tr> <tr> <td>VP1530A0</td> <td>BT CT RIGHT HANDLE LATC</td> <td>1.000</td> <td>PC</td> </tr> </tbody> </table>	Code	Description	Qty	UOM	VI1074A0	4X16 SCREW FOR PLASTIC	2.000	PC	VI1220A1	4,2x12 TCB SELF-TAPPIN G SCREW	2.000	PC	VM1460A0	XBC/XVC RIGHT DOOR LATCH CAP	1.000	PC	VP1530A0	BT CT RIGHT HANDLE LATC	1.000	PC					
Code	Description	Qty	UOM																						
VI1074A0	4X16 SCREW FOR PLASTIC	2.000	PC																						
VI1220A1	4,2x12 TCB SELF-TAPPIN G SCREW	2.000	PC																						
VM1460A0	XBC/XVC RIGHT DOOR LATCH CAP	1.000	PC																						
VP1530A0	BT CT RIGHT HANDLE LATC	1.000	PC																						
SB1015A	4L COMPLETE DETERGENT TANK		KSB1015A	4L DETERGENT TANK KIT	<table border="1"> <thead> <tr> <th>Code</th> <th>Description</th> <th>Qty</th> <th>UOM</th> </tr> </thead> <tbody> <tr> <td>SB1015A3</td> <td>4L COMPLETE DETERGENT TANK</td> <td>1.000</td> <td>PC</td> </tr> </tbody> </table>	Code	Description	Qty	UOM	SB1015A3	4L COMPLETE DETERGENT TANK	1.000	PC												
Code	Description	Qty	UOM																						
SB1015A3	4L COMPLETE DETERGENT TANK	1.000	PC																						



COMPONENT			SPARE PART																																																										
Code	Description	Image	Code	Description	Kit components																																																								
VM1118A	DET&Rinse PLUS TANK LEFT GUIDE		KVM1118A	DET&RINSE TANK LEFT GUIDE KIT FOR MM	<table border="1"> <thead> <tr> <th>Code</th> <th>Description</th> <th>Qty</th> <th>UOM</th> </tr> </thead> <tbody> <tr> <td>VH1220A1</td> <td>4,2x12 TCB SELF-TAPPIN G SCREW</td> <td>2.000</td> <td>PC</td> </tr> <tr> <td>VM1118A0</td> <td>DET&Rinse PLUS TANK LEFT GUIDE</td> <td>1.000</td> <td>PC</td> </tr> </tbody> </table>	Code	Description	Qty	UOM	VH1220A1	4,2x12 TCB SELF-TAPPIN G SCREW	2.000	PC	VM1118A0	DET&Rinse PLUS TANK LEFT GUIDE	1.000	PC																																												
Code	Description	Qty	UOM																																																										
VH1220A1	4,2x12 TCB SELF-TAPPIN G SCREW	2.000	PC																																																										
VM1118A0	DET&Rinse PLUS TANK LEFT GUIDE	1.000	PC																																																										
VM1119A	DET&Rinse PLUS TANK RIGHT GUIDE		KVM1119A	DET&RINSE TANK RIGHT GUIDE KIT FOR MM	<table border="1"> <thead> <tr> <th>Code</th> <th>Description</th> <th>Qty</th> <th>UOM</th> </tr> </thead> <tbody> <tr> <td>VH1220A1</td> <td>4,2x12 TCB SELF-TAPPIN G SCREW</td> <td>2.000</td> <td>PC</td> </tr> <tr> <td>VM1119A0</td> <td>DET&Rinse PLUS TANK RIGHT GUIDE</td> <td>1.000</td> <td>PC</td> </tr> </tbody> </table>	Code	Description	Qty	UOM	VH1220A1	4,2x12 TCB SELF-TAPPIN G SCREW	2.000	PC	VM1119A0	DET&Rinse PLUS TANK RIGHT GUIDE	1.000	PC																																												
Code	Description	Qty	UOM																																																										
VH1220A1	4,2x12 TCB SELF-TAPPIN G SCREW	2.000	PC																																																										
VM1119A0	DET&Rinse PLUS TANK RIGHT GUIDE	1.000	PC																																																										
VL1026A	BEND FOR DRAIN PIPE		KVL1026A	DRAIN PIPE BEND KI	<table border="1"> <thead> <tr> <th>Code</th> <th>Description</th> <th>Qty</th> <th>UOM</th> </tr> </thead> <tbody> <tr> <td>GN1400A0</td> <td>U-TRAP SEAL</td> <td>1.000</td> <td>PC</td> </tr> <tr> <td>VL1026A0</td> <td>BEND FOR DRAIN PIPE</td> <td>1.000</td> <td>PC</td> </tr> <tr> <td>VM2039A0</td> <td>DRAIN BEND FIXING RING</td> <td>1.000</td> <td>PC</td> </tr> </tbody> </table>	Code	Description	Qty	UOM	GN1400A0	U-TRAP SEAL	1.000	PC	VL1026A0	BEND FOR DRAIN PIPE	1.000	PC	VM2039A0	DRAIN BEND FIXING RING	1.000	PC																																								
Code	Description	Qty	UOM																																																										
GN1400A0	U-TRAP SEAL	1.000	PC																																																										
VL1026A0	BEND FOR DRAIN PIPE	1.000	PC																																																										
VM2039A0	DRAIN BEND FIXING RING	1.000	PC																																																										
VM2039A	DRAIN BEND FIXING RING		KVL1315A	CBX RECIRCULATION BOX KIT (NO PUMPS)	<table border="1"> <thead> <tr> <th>Code</th> <th>Description</th> <th>Qty</th> <th>UOM</th> </tr> </thead> <tbody> <tr> <td>0H6686A0</td> <td></td> <td>1.000</td> <td>PC</td> </tr> <tr> <td>GN1400A0</td> <td>U-TRAP SEAL</td> <td>1.000</td> <td>PC</td> </tr> <tr> <td>RC1019A0</td> <td>D=10 ELASTIC CLAMP</td> <td>2.000</td> <td>PC</td> </tr> <tr> <td>RC1243A0</td> <td>Ø10F-Ø10M ELBOW CONNECTION + JG END KIT</td> <td>1.000</td> <td>PC</td> </tr> <tr> <td>RC1360A0</td> <td>10 - 10 JG ELBOW FITTIN</td> <td>2.000</td> <td>PC</td> </tr> <tr> <td>RC1378A0</td> <td>HOSE CLAMP</td> <td>1.000</td> <td>PC</td> </tr> <tr> <td>RC1410A0</td> <td>ST STEEL HOSE CLAMP D16-27</td> <td>2.000</td> <td>PC</td> </tr> <tr> <td>SN1053A0</td> <td></td> <td>1.000</td> <td>PC</td> </tr> <tr> <td>SN1061A0</td> <td>D4x175MM NTC PROBE</td> <td>1.000</td> <td>PC</td> </tr> <tr> <td>TB3822A0</td> <td></td> <td>1.000</td> <td>PC</td> </tr> <tr> <td>TB4135A0</td> <td></td> <td>1.000</td> <td>PC</td> </tr> <tr> <td>TB4160A0</td> <td></td> <td>1.000</td> <td>PC</td> </tr> <tr> <td>VH1103A0</td> <td>40X12 TBSP SCREW FOR PLASTIC</td> <td>6.000</td> <td>PC</td> </tr> </tbody> </table>	Code	Description	Qty	UOM	0H6686A0		1.000	PC	GN1400A0	U-TRAP SEAL	1.000	PC	RC1019A0	D=10 ELASTIC CLAMP	2.000	PC	RC1243A0	Ø10F-Ø10M ELBOW CONNECTION + JG END KIT	1.000	PC	RC1360A0	10 - 10 JG ELBOW FITTIN	2.000	PC	RC1378A0	HOSE CLAMP	1.000	PC	RC1410A0	ST STEEL HOSE CLAMP D16-27	2.000	PC	SN1053A0		1.000	PC	SN1061A0	D4x175MM NTC PROBE	1.000	PC	TB3822A0		1.000	PC	TB4135A0		1.000	PC	TB4160A0		1.000	PC	VH1103A0	40X12 TBSP SCREW FOR PLASTIC	6.000	PC
Code	Description	Qty	UOM																																																										
0H6686A0		1.000	PC																																																										
GN1400A0	U-TRAP SEAL	1.000	PC																																																										
RC1019A0	D=10 ELASTIC CLAMP	2.000	PC																																																										
RC1243A0	Ø10F-Ø10M ELBOW CONNECTION + JG END KIT	1.000	PC																																																										
RC1360A0	10 - 10 JG ELBOW FITTIN	2.000	PC																																																										
RC1378A0	HOSE CLAMP	1.000	PC																																																										
RC1410A0	ST STEEL HOSE CLAMP D16-27	2.000	PC																																																										
SN1053A0		1.000	PC																																																										
SN1061A0	D4x175MM NTC PROBE	1.000	PC																																																										
TB3822A0		1.000	PC																																																										
TB4135A0		1.000	PC																																																										
TB4160A0		1.000	PC																																																										
VH1103A0	40X12 TBSP SCREW FOR PLASTIC	6.000	PC																																																										



COMPONENT			SPARE PART																																																																														
Code	Description	Image	Code	Description	Kit components																																																																												
VM2039A	DRAIN BEND FIXING RING		KVL1315A	CBX RECIRCULATION BOX KIT (NO PUMPS)	<table border="1"> <thead> <tr> <th>Code</th> <th>Description</th> <th>Qty</th> <th>UOM</th> </tr> </thead> <tbody> <tr> <td>VL1315A1</td> <td>ASM TANK BLOCK PUMPS DID</td> <td>1.000</td> <td>PC</td> </tr> <tr> <td>VL1340A0</td> <td>DID JG 10 M-M BYPASS CONNECTION</td> <td>1.000</td> <td>PC</td> </tr> <tr> <td>VL1400A0</td> <td>PARTIAL EDGE BENT DRAIN</td> <td>1.000</td> <td>PC</td> </tr> <tr> <td>VL1407A1</td> <td>DID PRESSURE REDUCER ASSEMBLY</td> <td>1.000</td> <td>PC</td> </tr> <tr> <td>VM1802A0</td> <td>DID TANKS FLAP PIN</td> <td>1.000</td> <td>PC</td> </tr> <tr> <td>VM2039A0</td> <td>DRAIN BEND FIXING RING</td> <td>1.000</td> <td>PC</td> </tr> <tr> <td>VM2640A0</td> <td>DRAIN PUMP PROTECTION</td> <td>1.000</td> <td>PC</td> </tr> </tbody> </table>	Code	Description	Qty	UOM	VL1315A1	ASM TANK BLOCK PUMPS DID	1.000	PC	VL1340A0	DID JG 10 M-M BYPASS CONNECTION	1.000	PC	VL1400A0	PARTIAL EDGE BENT DRAIN	1.000	PC	VL1407A1	DID PRESSURE REDUCER ASSEMBLY	1.000	PC	VM1802A0	DID TANKS FLAP PIN	1.000	PC	VM2039A0	DRAIN BEND FIXING RING	1.000	PC	VM2640A0	DRAIN PUMP PROTECTION	1.000	PC																																												
Code	Description	Qty	UOM																																																																														
VL1315A1	ASM TANK BLOCK PUMPS DID	1.000	PC																																																																														
VL1340A0	DID JG 10 M-M BYPASS CONNECTION	1.000	PC																																																																														
VL1400A0	PARTIAL EDGE BENT DRAIN	1.000	PC																																																																														
VL1407A1	DID PRESSURE REDUCER ASSEMBLY	1.000	PC																																																																														
VM1802A0	DID TANKS FLAP PIN	1.000	PC																																																																														
VM2039A0	DRAIN BEND FIXING RING	1.000	PC																																																																														
VM2640A0	DRAIN PUMP PROTECTION	1.000	PC																																																																														
			KVL1310A	COMPLETE CBX RECIRC TANK GROUP KIT	<table border="1"> <thead> <tr> <th>Code</th> <th>Description</th> <th>Qty</th> <th>UOM</th> </tr> </thead> <tbody> <tr> <td>0H5760A0</td> <td>CN1016 CAPACITOR COVER</td> <td>1.000</td> <td>PC</td> </tr> <tr> <td>0H6686A0</td> <td></td> <td>1.000</td> <td>PC</td> </tr> <tr> <td>CE2054A0</td> <td>DRAIN PUMP RAST 5 CABLE</td> <td>1.000</td> <td>PC</td> </tr> <tr> <td>CE2055A0</td> <td>CAVO RAST 5 POMPA RICIRCOLO</td> <td>1.000</td> <td>PC</td> </tr> <tr> <td>CN1016A0</td> <td>CE/UL 500V 2.5 uF CAPACITO</td> <td>1.000</td> <td>PC</td> </tr> <tr> <td>GN1400A0</td> <td>U-TRAP SEAL</td> <td>1.000</td> <td>PC</td> </tr> <tr> <td>PM1013A0</td> <td>240V 32W DRAIN PUMP</td> <td>1.000</td> <td>PC</td> </tr> <tr> <td>PM1018A0</td> <td>240V 100W RECYCLING PUMP</td> <td>1.000</td> <td>PC</td> </tr> <tr> <td>RC1019A0</td> <td>D=10 ELASTIC CLAMP</td> <td>2.000</td> <td>PC</td> </tr> <tr> <td>RC1046A0</td> <td>D10-16 H9 ST STEEL HOSE CLAMP</td> <td>1.000</td> <td>PC</td> </tr> <tr> <td>RC1360A0</td> <td>10 - 10 JG ELBOW FITTIN</td> <td>2.000</td> <td>PC</td> </tr> <tr> <td>RC1378A0</td> <td>HOSE CLAMP</td> <td>1.000</td> <td>PC</td> </tr> <tr> <td>RC1410A0</td> <td>ST STEEL HOSE CLAMP D16-27</td> <td>6.000</td> <td>PC</td> </tr> <tr> <td>SN1053A0</td> <td></td> <td>1.000</td> <td>PC</td> </tr> <tr> <td>SN1061A0</td> <td>D4x175MM NTC PROBE</td> <td>1.000</td> <td>PC</td> </tr> <tr> <td>TB3822A0</td> <td></td> <td>2.000</td> <td>PC</td> </tr> <tr> <td>TB4135A0</td> <td></td> <td>1.000</td> <td>PC</td> </tr> <tr> <td>TB4160A0</td> <td></td> <td>1.000</td> <td>PC</td> </tr> </tbody> </table>	Code	Description	Qty	UOM	0H5760A0	CN1016 CAPACITOR COVER	1.000	PC	0H6686A0		1.000	PC	CE2054A0	DRAIN PUMP RAST 5 CABLE	1.000	PC	CE2055A0	CAVO RAST 5 POMPA RICIRCOLO	1.000	PC	CN1016A0	CE/UL 500V 2.5 uF CAPACITO	1.000	PC	GN1400A0	U-TRAP SEAL	1.000	PC	PM1013A0	240V 32W DRAIN PUMP	1.000	PC	PM1018A0	240V 100W RECYCLING PUMP	1.000	PC	RC1019A0	D=10 ELASTIC CLAMP	2.000	PC	RC1046A0	D10-16 H9 ST STEEL HOSE CLAMP	1.000	PC	RC1360A0	10 - 10 JG ELBOW FITTIN	2.000	PC	RC1378A0	HOSE CLAMP	1.000	PC	RC1410A0	ST STEEL HOSE CLAMP D16-27	6.000	PC	SN1053A0		1.000	PC	SN1061A0	D4x175MM NTC PROBE	1.000	PC	TB3822A0		2.000	PC	TB4135A0		1.000	PC	TB4160A0		1.000	PC
Code	Description	Qty	UOM																																																																														
0H5760A0	CN1016 CAPACITOR COVER	1.000	PC																																																																														
0H6686A0		1.000	PC																																																																														
CE2054A0	DRAIN PUMP RAST 5 CABLE	1.000	PC																																																																														
CE2055A0	CAVO RAST 5 POMPA RICIRCOLO	1.000	PC																																																																														
CN1016A0	CE/UL 500V 2.5 uF CAPACITO	1.000	PC																																																																														
GN1400A0	U-TRAP SEAL	1.000	PC																																																																														
PM1013A0	240V 32W DRAIN PUMP	1.000	PC																																																																														
PM1018A0	240V 100W RECYCLING PUMP	1.000	PC																																																																														
RC1019A0	D=10 ELASTIC CLAMP	2.000	PC																																																																														
RC1046A0	D10-16 H9 ST STEEL HOSE CLAMP	1.000	PC																																																																														
RC1360A0	10 - 10 JG ELBOW FITTIN	2.000	PC																																																																														
RC1378A0	HOSE CLAMP	1.000	PC																																																																														
RC1410A0	ST STEEL HOSE CLAMP D16-27	6.000	PC																																																																														
SN1053A0		1.000	PC																																																																														
SN1061A0	D4x175MM NTC PROBE	1.000	PC																																																																														
TB3822A0		2.000	PC																																																																														
TB4135A0		1.000	PC																																																																														
TB4160A0		1.000	PC																																																																														





COMPONENT			SPARE PART																																																																																					
Code	Description	Image	Code	Description	Kit components																																																																																			
VM2039A	DRAIN BEND FIXING RING		KVL1310A	COMPLETE CBX RECIRC TANK GROUP KIT	<table border="1"> <thead> <tr> <th>Code</th> <th>Description</th> <th>Qty</th> <th>UOM</th> </tr> </thead> <tbody> <tr> <td>VI1103A0</td> <td>40X12 TBSP SCREW FOR PLASTIC</td> <td>9.000</td> <td>PC</td> </tr> <tr> <td>VI1220A1</td> <td>4,2x12 TCB SELF-TAPPING SCREW</td> <td>2.000</td> <td>PC</td> </tr> <tr> <td>VI1931A0</td> <td>M8x1.65 H4 CH13 ZINC PLATED NUT</td> <td>1.000</td> <td>PC</td> </tr> <tr> <td>VL1178A0</td> <td>EPDM O-RING INNER D 10.8 STRING 1.78</td> <td>2.000</td> <td>PC</td> </tr> <tr> <td>VL1315A1</td> <td>ASM TANK BLOCK PUMPS DID</td> <td>1.000</td> <td>PC</td> </tr> <tr> <td>VL1318A0</td> <td>SUPPORTO POMPA RICIRCOLO DI</td> <td>1.000</td> <td>PC</td> </tr> <tr> <td>VL1329A0</td> <td>D24-D16 FITTING</td> <td>1.000</td> <td>PC</td> </tr> <tr> <td>VL1332A0</td> <td>DID TANK CAP</td> <td>1.000</td> <td>PC</td> </tr> <tr> <td>VL1340A0</td> <td>DID JG 10 M-M BYPASS CONNECTION</td> <td>1.000</td> <td>PC</td> </tr> <tr> <td>VL1400A0</td> <td>PARTIAL EDGE BENT DRAIN</td> <td>1.000</td> <td>PC</td> </tr> <tr> <td>VL1407A1</td> <td>DID PRESSURE REDUCER ASSEMBLY</td> <td>1.000</td> <td>PC</td> </tr> <tr> <td>VM1794A0</td> <td>250x4.8 PA66 BLACK CLAMP</td> <td>1.000</td> <td>PC</td> </tr> <tr> <td>VM1802A0</td> <td>DID TANKS FLAP PIN</td> <td>1.000</td> <td>PC</td> </tr> <tr> <td>VM2039A0</td> <td>DRAIN BEND FIXING RING</td> <td>1.000</td> <td>PC</td> </tr> <tr> <td>VM2640A0</td> <td>DRAIN PUMP PROTECTION</td> <td>1.000</td> <td>PC</td> </tr> </tbody> </table>	Code	Description	Qty	UOM	VI1103A0	40X12 TBSP SCREW FOR PLASTIC	9.000	PC	VI1220A1	4,2x12 TCB SELF-TAPPING SCREW	2.000	PC	VI1931A0	M8x1.65 H4 CH13 ZINC PLATED NUT	1.000	PC	VL1178A0	EPDM O-RING INNER D 10.8 STRING 1.78	2.000	PC	VL1315A1	ASM TANK BLOCK PUMPS DID	1.000	PC	VL1318A0	SUPPORTO POMPA RICIRCOLO DI	1.000	PC	VL1329A0	D24-D16 FITTING	1.000	PC	VL1332A0	DID TANK CAP	1.000	PC	VL1340A0	DID JG 10 M-M BYPASS CONNECTION	1.000	PC	VL1400A0	PARTIAL EDGE BENT DRAIN	1.000	PC	VL1407A1	DID PRESSURE REDUCER ASSEMBLY	1.000	PC	VM1794A0	250x4.8 PA66 BLACK CLAMP	1.000	PC	VM1802A0	DID TANKS FLAP PIN	1.000	PC	VM2039A0	DRAIN BEND FIXING RING	1.000	PC	VM2640A0	DRAIN PUMP PROTECTION	1.000	PC	KVL1026A	DRAIN PIPE BEND KIT	<table border="1"> <thead> <tr> <th>Code</th> <th>Description</th> <th>Qty</th> <th>UOM</th> </tr> </thead> <tbody> <tr> <td>GN1400A0</td> <td>U-TRAP SEAL</td> <td>1.000</td> <td>PC</td> </tr> <tr> <td>VL1026A0</td> <td>BEND FOR DRAIN PIPE</td> <td>1.000</td> <td>PC</td> </tr> <tr> <td>VM2039A0</td> <td>DRAIN BEND FIXING RING</td> <td>1.000</td> <td>PC</td> </tr> </tbody> </table>	Code	Description	Qty	UOM	GN1400A0	U-TRAP SEAL	1.000	PC	VL1026A0	BEND FOR DRAIN PIPE	1.000	PC	VM2039A0	DRAIN BEND FIXING RING	1.000	PC
			Code	Description	Qty	UOM																																																																																		
VI1103A0	40X12 TBSP SCREW FOR PLASTIC	9.000	PC																																																																																					
VI1220A1	4,2x12 TCB SELF-TAPPING SCREW	2.000	PC																																																																																					
VI1931A0	M8x1.65 H4 CH13 ZINC PLATED NUT	1.000	PC																																																																																					
VL1178A0	EPDM O-RING INNER D 10.8 STRING 1.78	2.000	PC																																																																																					
VL1315A1	ASM TANK BLOCK PUMPS DID	1.000	PC																																																																																					
VL1318A0	SUPPORTO POMPA RICIRCOLO DI	1.000	PC																																																																																					
VL1329A0	D24-D16 FITTING	1.000	PC																																																																																					
VL1332A0	DID TANK CAP	1.000	PC																																																																																					
VL1340A0	DID JG 10 M-M BYPASS CONNECTION	1.000	PC																																																																																					
VL1400A0	PARTIAL EDGE BENT DRAIN	1.000	PC																																																																																					
VL1407A1	DID PRESSURE REDUCER ASSEMBLY	1.000	PC																																																																																					
VM1794A0	250x4.8 PA66 BLACK CLAMP	1.000	PC																																																																																					
VM1802A0	DID TANKS FLAP PIN	1.000	PC																																																																																					
VM2039A0	DRAIN BEND FIXING RING	1.000	PC																																																																																					
VM2640A0	DRAIN PUMP PROTECTION	1.000	PC																																																																																					
Code	Description	Qty	UOM																																																																																					
GN1400A0	U-TRAP SEAL	1.000	PC																																																																																					
VL1026A0	BEND FOR DRAIN PIPE	1.000	PC																																																																																					
VM2039A0	DRAIN BEND FIXING RING	1.000	PC																																																																																					



COMPONENT			SPARE PART																		
Code	Description	Image	Code	Description	Kit components																
VM1555A	CT BT COOLING FAN SUPPORT		KVN1165A	1.5E ADVANCE/MM 230V COOLING FAN KIT	<table border="1"> <thead> <tr> <th>Code</th> <th>Description</th> <th>Qty</th> <th>UOM</th> </tr> </thead> <tbody> <tr> <td>VI1099A0</td> <td>SELF-DRILLING G SCREW 4.8X13 TCB+ Z</td> <td>4.000</td> <td>PC</td> </tr> <tr> <td>VM1555A2</td> <td>CT BT COOLING FAN SUPPORT</td> <td>1.000</td> <td>PC</td> </tr> <tr> <td>VN1165A0</td> <td>230Vac 50/60Hz COOLING DOWN FAN</td> <td>1.000</td> <td>PC</td> </tr> </tbody> </table>	Code	Description	Qty	UOM	VI1099A0	SELF-DRILLING G SCREW 4.8X13 TCB+ Z	4.000	PC	VM1555A2	CT BT COOLING FAN SUPPORT	1.000	PC	VN1165A0	230Vac 50/60Hz COOLING DOWN FAN	1.000	PC
					Code	Description	Qty	UOM													
VI1099A0	SELF-DRILLING G SCREW 4.8X13 TCB+ Z	4.000	PC																		
VM1555A2	CT BT COOLING FAN SUPPORT	1.000	PC																		
VN1165A0	230Vac 50/60Hz COOLING DOWN FAN	1.000	PC																		
<table border="1"> <thead> <tr> <th>Code</th> <th>Description</th> <th>Qty</th> <th>UOM</th> </tr> </thead> <tbody> <tr> <td>VI1099A0</td> <td>SELF-DRILLING G SCREW 4.8X13 TCB+ Z</td> <td>4.000</td> <td>PC</td> </tr> <tr> <td>VM1555A2</td> <td>CT BT COOLING FAN SUPPORT</td> <td>1.000</td> <td>PC</td> </tr> <tr> <td>VN1164A0</td> <td>12VDC COOLING DOWN FAN</td> <td>1.000</td> <td>PC</td> </tr> </tbody> </table>	Code	Description	Qty	UOM	VI1099A0	SELF-DRILLING G SCREW 4.8X13 TCB+ Z	4.000	PC	VM1555A2	CT BT COOLING FAN SUPPORT	1.000	PC	VN1164A0	12VDC COOLING DOWN FAN	1.000	PC					
Code	Description	Qty	UOM																		
VI1099A0	SELF-DRILLING G SCREW 4.8X13 TCB+ Z	4.000	PC																		
VM1555A2	CT BT COOLING FAN SUPPORT	1.000	PC																		
VN1164A0	12VDC COOLING DOWN FAN	1.000	PC																		
VM1556A	XBC-XVC COOLING FAN GUARD		KVM1556A	XBC-XVC COOLING FAN GUARD KIT	<table border="1"> <thead> <tr> <th>Code</th> <th>Description</th> <th>Qty</th> <th>UOM</th> </tr> </thead> <tbody> <tr> <td>VM1556A0</td> <td>XBC-XVC COOLING FAN GUARD</td> <td>1.000</td> <td>PC</td> </tr> </tbody> </table>	Code	Description	Qty	UOM	VM1556A0	XBC-XVC COOLING FAN GUARD	1.000	PC								
					Code	Description	Qty	UOM													
VM1556A0	XBC-XVC COOLING FAN GUARD	1.000	PC																		
<table border="1"> <thead> <tr> <th>Code</th> <th>Description</th> <th>Qty</th> <th>UOM</th> </tr> </thead> <tbody> <tr> <td>VM1556A0</td> <td>XBC-XVC COOLING FAN GUARD</td> <td>1.000</td> <td>PC</td> </tr> </tbody> </table>	Code	Description	Qty	UOM	VM1556A0	XBC-XVC COOLING FAN GUARD	1.000	PC													
Code	Description	Qty	UOM																		
VM1556A0	XBC-XVC COOLING FAN GUARD	1.000	PC																		
VN1165A	230Vac 50/60Hz COOLING DOWN FAN		KVN1165A	1.5E ADVANCE/MM 230V COOLING FAN KIT	<table border="1"> <thead> <tr> <th>Code</th> <th>Description</th> <th>Qty</th> <th>UOM</th> </tr> </thead> <tbody> <tr> <td>VI1099A0</td> <td>SELF-DRILLING G SCREW 4.8X13 TCB+ Z</td> <td>4.000</td> <td>PC</td> </tr> <tr> <td>VM1555A2</td> <td>CT BT COOLING FAN SUPPORT</td> <td>1.000</td> <td>PC</td> </tr> <tr> <td>VN1165A0</td> <td>230Vac 50/60Hz COOLING DOWN FAN</td> <td>1.000</td> <td>PC</td> </tr> </tbody> </table>	Code	Description	Qty	UOM	VI1099A0	SELF-DRILLING G SCREW 4.8X13 TCB+ Z	4.000	PC	VM1555A2	CT BT COOLING FAN SUPPORT	1.000	PC	VN1165A0	230Vac 50/60Hz COOLING DOWN FAN	1.000	PC
					Code	Description	Qty	UOM													
VI1099A0	SELF-DRILLING G SCREW 4.8X13 TCB+ Z	4.000	PC																		
VM1555A2	CT BT COOLING FAN SUPPORT	1.000	PC																		
VN1165A0	230Vac 50/60Hz COOLING DOWN FAN	1.000	PC																		
<table border="1"> <thead> <tr> <th>Code</th> <th>Description</th> <th>Qty</th> <th>UOM</th> </tr> </thead> <tbody> <tr> <td>VM1555A2</td> <td>CT BT COOLING FAN SUPPORT</td> <td>1.000</td> <td>PC</td> </tr> <tr> <td>VN1165A0</td> <td>230Vac 50/60Hz COOLING DOWN FAN</td> <td>1.000</td> <td>PC</td> </tr> </tbody> </table>	Code	Description	Qty	UOM	VM1555A2	CT BT COOLING FAN SUPPORT	1.000	PC	VN1165A0	230Vac 50/60Hz COOLING DOWN FAN	1.000	PC									
Code	Description	Qty	UOM																		
VM1555A2	CT BT COOLING FAN SUPPORT	1.000	PC																		
VN1165A0	230Vac 50/60Hz COOLING DOWN FAN	1.000	PC																		
0H8039A	MM COMPACT REDUCER SUPPORT PLATE		0H8039A0	MM COMPACT REDUCER SUPPORT PLATE																	

COMPONENT			SPARE PART																						
Code	Description	Image	Code	Description	Kit components																				
RC1396A	JG D10-1/4 STRAIGHT END FITTING		KVL0014B	≥2017 MIND.MAPS PRESSURE REDUCER KIT	<table border="1"> <thead> <tr> <th>Code</th> <th>Description</th> <th>Qty</th> <th>UOM</th> </tr> </thead> <tbody> <tr> <td>RC1372A0</td> <td>Ø10M-1/4 M CIL. STRAIGHT FITTING</td> <td>1.000</td> <td>PC</td> </tr> <tr> <td>RC1396A0</td> <td>JG D10-1/4 STRAIGHT END FITTING</td> <td>1.000</td> <td>PC</td> </tr> <tr> <td>VL1014B3</td> <td>VL1014B3</td> <td>1.000</td> <td>PC</td> </tr> <tr> <td>VM1054A0</td> <td>H7.8 PRESSURE REDUCER RING NUT</td> <td>1.000</td> <td>PC</td> </tr> </tbody> </table>	Code	Description	Qty	UOM	RC1372A0	Ø10M-1/4 M CIL. STRAIGHT FITTING	1.000	PC	RC1396A0	JG D10-1/4 STRAIGHT END FITTING	1.000	PC	VL1014B3	VL1014B3	1.000	PC	VM1054A0	H7.8 PRESSURE REDUCER RING NUT	1.000	PC
					Code	Description	Qty	UOM																	
					RC1372A0	Ø10M-1/4 M CIL. STRAIGHT FITTING	1.000	PC																	
					RC1396A0	JG D10-1/4 STRAIGHT END FITTING	1.000	PC																	
VL1014B3	VL1014B3	1.000	PC																						
VM1054A0	H7.8 PRESSURE REDUCER RING NUT	1.000	PC																						
<table border="1"> <thead> <tr> <th>Code</th> <th>Description</th> <th>Qty</th> <th>UOM</th> </tr> </thead> <tbody> <tr> <td>RC1396A0</td> <td>JG D10-1/4 STRAIGHT END FITTING</td> <td>2.000</td> <td>PC</td> </tr> <tr> <td>VL1014B3</td> <td>VL1014B3</td> <td>1.000</td> <td>PC</td> </tr> <tr> <td>VM1054A0</td> <td>H7.8 PRESSURE REDUCER RING NUT</td> <td>1.000</td> <td>PC</td> </tr> </tbody> </table>	Code	Description	Qty	UOM	RC1396A0	JG D10-1/4 STRAIGHT END FITTING	2.000	PC	VL1014B3	VL1014B3	1.000	PC	VM1054A0	H7.8 PRESSURE REDUCER RING NUT	1.000	PC									
Code	Description	Qty	UOM																						
RC1396A0	JG D10-1/4 STRAIGHT END FITTING	2.000	PC																						
VL1014B3	VL1014B3	1.000	PC																						
VM1054A0	H7.8 PRESSURE REDUCER RING NUT	1.000	PC																						
<table border="1"> <thead> <tr> <th>Code</th> <th>Description</th> <th>Qty</th> <th>UOM</th> </tr> </thead> <tbody> <tr> <td>RC1372A0</td> <td>Ø10M-1/4 M CIL. STRAIGHT FITTING</td> <td>1.000</td> <td>PC</td> </tr> <tr> <td>RC1396A0</td> <td>JG D10-1/4 STRAIGHT END FITTING</td> <td>1.000</td> <td>PC</td> </tr> <tr> <td>VL1014B3</td> <td>VL1014B3</td> <td>1.000</td> <td>PC</td> </tr> <tr> <td>VM1054A0</td> <td>H7.8 PRESSURE REDUCER RING NUT</td> <td>1.000</td> <td>PC</td> </tr> </tbody> </table>	Code	Description	Qty	UOM	RC1372A0	Ø10M-1/4 M CIL. STRAIGHT FITTING	1.000	PC	RC1396A0	JG D10-1/4 STRAIGHT END FITTING	1.000	PC	VL1014B3	VL1014B3	1.000	PC	VM1054A0	H7.8 PRESSURE REDUCER RING NUT	1.000	PC					
Code	Description	Qty	UOM																						
RC1372A0	Ø10M-1/4 M CIL. STRAIGHT FITTING	1.000	PC																						
RC1396A0	JG D10-1/4 STRAIGHT END FITTING	1.000	PC																						
VL1014B3	VL1014B3	1.000	PC																						
VM1054A0	H7.8 PRESSURE REDUCER RING NUT	1.000	PC																						
<table border="1"> <thead> <tr> <th>Code</th> <th>Description</th> <th>Qty</th> <th>UOM</th> </tr> </thead> <tbody> <tr> <td>RC1372A0</td> <td>Ø10M-1/4 M CIL. STRAIGHT FITTING</td> <td>2.000</td> <td>PC</td> </tr> <tr> <td>VL1014B3</td> <td>VL1014B3</td> <td>1.000</td> <td>PC</td> </tr> <tr> <td>VM1054A0</td> <td>H7.8 PRESSURE REDUCER RING NUT</td> <td>1.000</td> <td>PC</td> </tr> </tbody> </table>	Code	Description	Qty	UOM	RC1372A0	Ø10M-1/4 M CIL. STRAIGHT FITTING	2.000	PC	VL1014B3	VL1014B3	1.000	PC	VM1054A0	H7.8 PRESSURE REDUCER RING NUT	1.000	PC									
Code	Description	Qty	UOM																						
RC1372A0	Ø10M-1/4 M CIL. STRAIGHT FITTING	2.000	PC																						
VL1014B3	VL1014B3	1.000	PC																						
VM1054A0	H7.8 PRESSURE REDUCER RING NUT	1.000	PC																						
VL1014B	VL1014B3		KVL0020A	PRESS.REDUCER 03-05XX≥OCT18/MM -LUX≥MAR19	<table border="1"> <thead> <tr> <th>Code</th> <th>Description</th> <th>Qty</th> <th>UOM</th> </tr> </thead> <tbody> <tr> <td>RC1396A0</td> <td>JG D10-1/4 STRAIGHT END FITTING</td> <td>2.000</td> <td>PC</td> </tr> <tr> <td>VL1014B3</td> <td>VL1014B3</td> <td>1.000</td> <td>PC</td> </tr> <tr> <td>VM1054A0</td> <td>H7.8 PRESSURE REDUCER RING NUT</td> <td>1.000</td> <td>PC</td> </tr> </tbody> </table>	Code	Description	Qty	UOM	RC1396A0	JG D10-1/4 STRAIGHT END FITTING	2.000	PC	VL1014B3	VL1014B3	1.000	PC	VM1054A0	H7.8 PRESSURE REDUCER RING NUT	1.000	PC				
			Code	Description	Qty	UOM																			
			RC1396A0	JG D10-1/4 STRAIGHT END FITTING	2.000	PC																			
			VL1014B3	VL1014B3	1.000	PC																			
VM1054A0	H7.8 PRESSURE REDUCER RING NUT	1.000	PC																						
KVL0014B	≥2017 MIND.MAPS PRESSURE REDUCER KIT	<table border="1"> <thead> <tr> <th>Code</th> <th>Description</th> <th>Qty</th> <th>UOM</th> </tr> </thead> <tbody> <tr> <td>RC1372A0</td> <td>Ø10M-1/4 M CIL. STRAIGHT FITTING</td> <td>1.000</td> <td>PC</td> </tr> <tr> <td>RC1396A0</td> <td>JG D10-1/4 STRAIGHT END FITTING</td> <td>1.000</td> <td>PC</td> </tr> <tr> <td>VL1014B3</td> <td>VL1014B3</td> <td>1.000</td> <td>PC</td> </tr> <tr> <td>VM1054A0</td> <td>H7.8 PRESSURE REDUCER RING NUT</td> <td>1.000</td> <td>PC</td> </tr> </tbody> </table>	Code	Description	Qty	UOM	RC1372A0	Ø10M-1/4 M CIL. STRAIGHT FITTING	1.000	PC	RC1396A0	JG D10-1/4 STRAIGHT END FITTING	1.000	PC	VL1014B3	VL1014B3	1.000	PC	VM1054A0	H7.8 PRESSURE REDUCER RING NUT	1.000	PC			
Code	Description	Qty	UOM																						
RC1372A0	Ø10M-1/4 M CIL. STRAIGHT FITTING	1.000	PC																						
RC1396A0	JG D10-1/4 STRAIGHT END FITTING	1.000	PC																						
VL1014B3	VL1014B3	1.000	PC																						
VM1054A0	H7.8 PRESSURE REDUCER RING NUT	1.000	PC																						
KVL0014A	MM ≤2016 / LUX<2019 PRESSURE REDUCER KIT	<table border="1"> <thead> <tr> <th>Code</th> <th>Description</th> <th>Qty</th> <th>UOM</th> </tr> </thead> <tbody> <tr> <td>RC1372A0</td> <td>Ø10M-1/4 M CIL. STRAIGHT FITTING</td> <td>2.000</td> <td>PC</td> </tr> <tr> <td>VL1014B3</td> <td>VL1014B3</td> <td>1.000</td> <td>PC</td> </tr> <tr> <td>VM1054A0</td> <td>H7.8 PRESSURE REDUCER RING NUT</td> <td>1.000</td> <td>PC</td> </tr> </tbody> </table>	Code	Description	Qty	UOM	RC1372A0	Ø10M-1/4 M CIL. STRAIGHT FITTING	2.000	PC	VL1014B3	VL1014B3	1.000	PC	VM1054A0	H7.8 PRESSURE REDUCER RING NUT	1.000	PC							
Code	Description	Qty	UOM																						
RC1372A0	Ø10M-1/4 M CIL. STRAIGHT FITTING	2.000	PC																						
VL1014B3	VL1014B3	1.000	PC																						
VM1054A0	H7.8 PRESSURE REDUCER RING NUT	1.000	PC																						
KVL0010A	S.4 - 5 WATER PRESSURE REDUCER KIT	<table border="1"> <thead> <tr> <th>Code</th> <th>Description</th> <th>Qty</th> <th>UOM</th> </tr> </thead> <tbody> <tr> <td>EL1210A0</td> <td>D8-BSP1/4 JG STRAIGHT END CONNECTION</td> <td>2.000</td> <td>PC</td> </tr> <tr> <td>VL1014B3</td> <td>VL1014B3</td> <td>1.000</td> <td>PC</td> </tr> </tbody> </table>	Code	Description	Qty	UOM	EL1210A0	D8-BSP1/4 JG STRAIGHT END CONNECTION	2.000	PC	VL1014B3	VL1014B3	1.000	PC											
Code	Description	Qty	UOM																						
EL1210A0	D8-BSP1/4 JG STRAIGHT END CONNECTION	2.000	PC																						
VL1014B3	VL1014B3	1.000	PC																						

COMPONENT			SPARE PART																																										
Code	Description	Image	Code	Description	Kit components																																								
VM1054A	H7.8 PRESSURE REDUCER RING NUT		KVM1054A	H7.8 PRESSURE REDUCER DIAL KIT	<table border="1"> <thead> <tr> <th>Code</th> <th>Description</th> <th>Qty</th> <th>UOM</th> </tr> </thead> <tbody> <tr> <td>VM1054A0</td> <td>H7.8 PRESSURE REDUCER RING NUT</td> <td>1.000</td> <td>PC</td> </tr> </tbody> </table>	Code	Description	Qty	UOM	VM1054A0	H7.8 PRESSURE REDUCER RING NUT	1.000	PC																																
			Code	Description	Qty	UOM																																							
VM1054A0	H7.8 PRESSURE REDUCER RING NUT	1.000	PC																																										
KVL1117A	EUR MM 2016+LMT FILTER+PRESS. RED. KIT	<table border="1"> <thead> <tr> <th>Code</th> <th>Description</th> <th>Qty</th> <th>UOM</th> </tr> </thead> <tbody> <tr> <td>0H7472A1</td> <td>DISTRIBUTOR SUPPORT PLATE</td> <td>1.000</td> <td>PC</td> </tr> <tr> <td>RC1004A0</td> <td>Ø10-Ø8-8 Y CONNECTION</td> <td>1.000</td> <td>PC</td> </tr> <tr> <td>RC1243A0</td> <td>Ø10F-Ø10M ELBOW CONNECTION + JG END KIT</td> <td>1.000</td> <td>PC</td> </tr> <tr> <td>RC1372A0</td> <td>Ø10M-1/4 M CIL. STRAIGHT FITTING</td> <td>2.000</td> <td>PC</td> </tr> <tr> <td>VI1220A1</td> <td>4,2x12 TCB SELF-TAPPING SCREW</td> <td>4.000</td> <td>PC</td> </tr> <tr> <td>VL1014B3</td> <td>VL1014B3 FILTER D10</td> <td>1.000</td> <td>PC</td> </tr> <tr> <td>VL1034C0</td> <td>MESH WATER FILTER D10</td> <td>1.000</td> <td>PC</td> </tr> <tr> <td>VL1062C0</td> <td>PRESSURE REDUCER-FILTER LOCKING FORK</td> <td>1.000</td> <td>PC</td> </tr> <tr> <td>VM1054A0</td> <td>H7.8 PRESSURE REDUCER RING NUT</td> <td>1.000</td> <td>PC</td> </tr> </tbody> </table>	Code	Description	Qty	UOM	0H7472A1	DISTRIBUTOR SUPPORT PLATE	1.000	PC	RC1004A0	Ø10-Ø8-8 Y CONNECTION	1.000	PC	RC1243A0	Ø10F-Ø10M ELBOW CONNECTION + JG END KIT	1.000	PC	RC1372A0	Ø10M-1/4 M CIL. STRAIGHT FITTING	2.000	PC	VI1220A1	4,2x12 TCB SELF-TAPPING SCREW	4.000	PC	VL1014B3	VL1014B3 FILTER D10	1.000	PC	VL1034C0	MESH WATER FILTER D10	1.000	PC	VL1062C0	PRESSURE REDUCER-FILTER LOCKING FORK	1.000	PC	VM1054A0	H7.8 PRESSURE REDUCER RING NUT	1.000	PC			
Code	Description	Qty	UOM																																										
0H7472A1	DISTRIBUTOR SUPPORT PLATE	1.000	PC																																										
RC1004A0	Ø10-Ø8-8 Y CONNECTION	1.000	PC																																										
RC1243A0	Ø10F-Ø10M ELBOW CONNECTION + JG END KIT	1.000	PC																																										
RC1372A0	Ø10M-1/4 M CIL. STRAIGHT FITTING	2.000	PC																																										
VI1220A1	4,2x12 TCB SELF-TAPPING SCREW	4.000	PC																																										
VL1014B3	VL1014B3 FILTER D10	1.000	PC																																										
VL1034C0	MESH WATER FILTER D10	1.000	PC																																										
VL1062C0	PRESSURE REDUCER-FILTER LOCKING FORK	1.000	PC																																										
VM1054A0	H7.8 PRESSURE REDUCER RING NUT	1.000	PC																																										
RC1243A	Ø10F-Ø10M ELBOW CONNECTION + JG END KIT		KVL1413A	EU SPEED-X HOOD WASHING KIT	<table border="1"> <thead> <tr> <th>Code</th> <th>Description</th> <th>Qty</th> <th>UOM</th> </tr> </thead> <tbody> <tr> <td>0H2514A1</td> <td>EL1440 HOLDING PANEL</td> <td>1.000</td> <td>PC</td> </tr> <tr> <td>0H5472A0</td> <td></td> <td>1.000</td> <td>PC</td> </tr> <tr> <td>EL1440A0</td> <td>WATER SELF-CLEANING VALVE</td> <td>1.000</td> <td>PC</td> </tr> <tr> <td>GN1526A0</td> <td>INT. D.=6.9 TH=1.8 O-RING</td> <td>2.000</td> <td>PC</td> </tr> <tr> <td>RC1018A0</td> <td>ZINC PLATED D12 ELASTIC CLAMP</td> <td>4.000</td> <td>PC</td> </tr> <tr> <td>RC1243A0</td> <td>Ø10F-Ø10M ELBOW CONNECTION + JG END KIT</td> <td>1.000</td> <td>PC</td> </tr> <tr> <td>RC1396A0</td> <td>JG D10-1/4 STRAIGHT END FITTING</td> <td>2.000</td> <td>PC</td> </tr> <tr> <td>TB3252A0</td> <td>TB3252A0</td> <td>1.000</td> <td>PC</td> </tr> <tr> <td>TB3426A0</td> <td></td> <td>1.000</td> <td>PC</td> </tr> </tbody> </table>	Code	Description	Qty	UOM	0H2514A1	EL1440 HOLDING PANEL	1.000	PC	0H5472A0		1.000	PC	EL1440A0	WATER SELF-CLEANING VALVE	1.000	PC	GN1526A0	INT. D.=6.9 TH=1.8 O-RING	2.000	PC	RC1018A0	ZINC PLATED D12 ELASTIC CLAMP	4.000	PC	RC1243A0	Ø10F-Ø10M ELBOW CONNECTION + JG END KIT	1.000	PC	RC1396A0	JG D10-1/4 STRAIGHT END FITTING	2.000	PC	TB3252A0	TB3252A0	1.000	PC	TB3426A0		1.000	PC
			Code	Description	Qty	UOM																																							
0H2514A1	EL1440 HOLDING PANEL	1.000	PC																																										
0H5472A0		1.000	PC																																										
EL1440A0	WATER SELF-CLEANING VALVE	1.000	PC																																										
GN1526A0	INT. D.=6.9 TH=1.8 O-RING	2.000	PC																																										
RC1018A0	ZINC PLATED D12 ELASTIC CLAMP	4.000	PC																																										
RC1243A0	Ø10F-Ø10M ELBOW CONNECTION + JG END KIT	1.000	PC																																										
RC1396A0	JG D10-1/4 STRAIGHT END FITTING	2.000	PC																																										
TB3252A0	TB3252A0	1.000	PC																																										
TB3426A0		1.000	PC																																										



COMPONENT			SPARE PART																																																							
Code	Description	Image	Code	Description	Kit components																																																					
RC1243A	Ø10F-Ø10M ELBOW CONNECTION + JG END KIT		KVL1413A	EU SPEED-X HOOD WASHING KIT	<table border="1"> <thead> <tr> <th>Code</th> <th>Description</th> <th>Qty</th> <th>UOM</th> </tr> </thead> <tbody> <tr> <td>VI1220A1</td> <td>4,2x12 TCB SELF-TAPPIN G SCREW</td> <td>2.000</td> <td>PC</td> </tr> <tr> <td>VL1014B3</td> <td>VL1014B3</td> <td>1.000</td> <td>PC</td> </tr> <tr> <td>VL1095A0</td> <td>D7.8-D10 RUBBER HOLDER M-M FITTING</td> <td>1.000</td> <td>PC</td> </tr> <tr> <td>VL1165A0</td> <td>BAM-BB6 STRAIGHT FITTING</td> <td>2.000</td> <td>PC</td> </tr> <tr> <td>VM1054A0</td> <td>H7.8 PRESSURE REDUCER RING NUT</td> <td>1.000</td> <td>PC</td> </tr> <tr> <td>VM1605A0</td> <td>CLIP TWIST LOCK DIAM. 10,2-12,7 MM</td> <td>1.000</td> <td>PC</td> </tr> <tr> <td>VM2652A0</td> <td>WIRING SADDLE</td> <td>1.000</td> <td>PC</td> </tr> </tbody> </table>	Code	Description	Qty	UOM	VI1220A1	4,2x12 TCB SELF-TAPPIN G SCREW	2.000	PC	VL1014B3	VL1014B3	1.000	PC	VL1095A0	D7.8-D10 RUBBER HOLDER M-M FITTING	1.000	PC	VL1165A0	BAM-BB6 STRAIGHT FITTING	2.000	PC	VM1054A0	H7.8 PRESSURE REDUCER RING NUT	1.000	PC	VM1605A0	CLIP TWIST LOCK DIAM. 10,2-12,7 MM	1.000	PC	VM2652A0	WIRING SADDLE	1.000	PC																					
			Code	Description	Qty	UOM																																																				
			VI1220A1	4,2x12 TCB SELF-TAPPIN G SCREW	2.000	PC																																																				
VL1014B3	VL1014B3	1.000	PC																																																							
VL1095A0	D7.8-D10 RUBBER HOLDER M-M FITTING	1.000	PC																																																							
VL1165A0	BAM-BB6 STRAIGHT FITTING	2.000	PC																																																							
VM1054A0	H7.8 PRESSURE REDUCER RING NUT	1.000	PC																																																							
VM1605A0	CLIP TWIST LOCK DIAM. 10,2-12,7 MM	1.000	PC																																																							
VM2652A0	WIRING SADDLE	1.000	PC																																																							
KVL1407A	CBX PRESS.REDUCER KIT 1.3 BAR	<table border="1"> <thead> <tr> <th>Code</th> <th>Description</th> <th>Qty</th> <th>UOM</th> </tr> </thead> <tbody> <tr> <td>RC1243A0</td> <td>Ø10F-Ø10M ELBOW CONNECTION + JG END KIT</td> <td>1.000</td> <td>PC</td> </tr> <tr> <td>RC1396A0</td> <td>JG D10-1/4 STRAIGHT END FITTING</td> <td>2.000</td> <td>PC</td> </tr> <tr> <td>VL1279A1</td> <td>PRESSURE REDUCER</td> <td>1.000</td> <td>PC</td> </tr> </tbody> </table>	Code	Description	Qty	UOM	RC1243A0	Ø10F-Ø10M ELBOW CONNECTION + JG END KIT	1.000	PC	RC1396A0	JG D10-1/4 STRAIGHT END FITTING	2.000	PC	VL1279A1	PRESSURE REDUCER	1.000	PC																																								
Code	Description	Qty	UOM																																																							
RC1243A0	Ø10F-Ø10M ELBOW CONNECTION + JG END KIT	1.000	PC																																																							
RC1396A0	JG D10-1/4 STRAIGHT END FITTING	2.000	PC																																																							
VL1279A1	PRESSURE REDUCER	1.000	PC																																																							
KVL1315A	CBX RECIRCULATION BOX KIT (NO PUMPS)	<table border="1"> <thead> <tr> <th>Code</th> <th>Description</th> <th>Qty</th> <th>UOM</th> </tr> </thead> <tbody> <tr> <td>0H6686A0</td> <td></td> <td>1.000</td> <td>PC</td> </tr> <tr> <td>GN1400A0</td> <td>U-TRAP SEAL</td> <td>1.000</td> <td>PC</td> </tr> <tr> <td>RC1019A0</td> <td>D=10 ELASTIC CLAMP</td> <td>2.000</td> <td>PC</td> </tr> <tr> <td>RC1243A0</td> <td>Ø10F-Ø10M ELBOW CONNECTION + JG END KIT</td> <td>1.000</td> <td>PC</td> </tr> <tr> <td>RC1360A0</td> <td>10 - 10 JG ELBOW FITTING</td> <td>2.000</td> <td>PC</td> </tr> <tr> <td>RC1378A0</td> <td>HOSE CLAMP</td> <td>1.000</td> <td>PC</td> </tr> <tr> <td>RC1410A0</td> <td>ST STEEL HOSE CLAMP D16-27</td> <td>2.000</td> <td>PC</td> </tr> <tr> <td>SN1053A0</td> <td></td> <td>1.000</td> <td>PC</td> </tr> <tr> <td>SN1061A0</td> <td>D4x175MM NTC PROBE</td> <td>1.000</td> <td>PC</td> </tr> <tr> <td>TB3822A0</td> <td></td> <td>1.000</td> <td>PC</td> </tr> <tr> <td>TB4135A0</td> <td></td> <td>1.000</td> <td>PC</td> </tr> <tr> <td>TB4160A0</td> <td></td> <td>1.000</td> <td>PC</td> </tr> <tr> <td>VI1103A0</td> <td>40X12 TBSP SCREW FOR PLASTIC</td> <td>6.000</td> <td>PC</td> </tr> </tbody> </table>	Code	Description	Qty	UOM	0H6686A0		1.000	PC	GN1400A0	U-TRAP SEAL	1.000	PC	RC1019A0	D=10 ELASTIC CLAMP	2.000	PC	RC1243A0	Ø10F-Ø10M ELBOW CONNECTION + JG END KIT	1.000	PC	RC1360A0	10 - 10 JG ELBOW FITTING	2.000	PC	RC1378A0	HOSE CLAMP	1.000	PC	RC1410A0	ST STEEL HOSE CLAMP D16-27	2.000	PC	SN1053A0		1.000	PC	SN1061A0	D4x175MM NTC PROBE	1.000	PC	TB3822A0		1.000	PC	TB4135A0		1.000	PC	TB4160A0		1.000	PC	VI1103A0	40X12 TBSP SCREW FOR PLASTIC	6.000	PC
Code	Description	Qty	UOM																																																							
0H6686A0		1.000	PC																																																							
GN1400A0	U-TRAP SEAL	1.000	PC																																																							
RC1019A0	D=10 ELASTIC CLAMP	2.000	PC																																																							
RC1243A0	Ø10F-Ø10M ELBOW CONNECTION + JG END KIT	1.000	PC																																																							
RC1360A0	10 - 10 JG ELBOW FITTING	2.000	PC																																																							
RC1378A0	HOSE CLAMP	1.000	PC																																																							
RC1410A0	ST STEEL HOSE CLAMP D16-27	2.000	PC																																																							
SN1053A0		1.000	PC																																																							
SN1061A0	D4x175MM NTC PROBE	1.000	PC																																																							
TB3822A0		1.000	PC																																																							
TB4135A0		1.000	PC																																																							
TB4160A0		1.000	PC																																																							
VI1103A0	40X12 TBSP SCREW FOR PLASTIC	6.000	PC																																																							





COMPONENT			SPARE PART																																																																											
Code	Description	Image	Code	Description	Kit components																																																																									
RC1243A	Ø10F-Ø10M ELBOW CONNECTION + JG END KIT		KVL1315A	CBX RECIRCULATION BOX KIT (NO PUMPS)	<table border="1"> <thead> <tr> <th>Code</th> <th>Description</th> <th>Qty</th> <th>UOM</th> </tr> </thead> <tbody> <tr> <td>VL1315A1</td> <td>ASM TANK BLOCK PUMPS DID</td> <td>1.000</td> <td>PC</td> </tr> <tr> <td>VL1340A0</td> <td>DID JG 10 M-M BYPASS CONNECTION</td> <td>1.000</td> <td>PC</td> </tr> <tr> <td>VL1400A0</td> <td>PARTIAL EDGE BENT DRAIN</td> <td>1.000</td> <td>PC</td> </tr> <tr> <td>VL1407A1</td> <td>DID PRESSURE REDUCER ASSEMBLY</td> <td>1.000</td> <td>PC</td> </tr> <tr> <td>VM1802A0</td> <td>DID TANKS FLAP PIN</td> <td>1.000</td> <td>PC</td> </tr> <tr> <td>VM2039A0</td> <td>DRAIN BEND FIXING RING</td> <td>1.000</td> <td>PC</td> </tr> <tr> <td>VM2640A0</td> <td>DRAIN PUMP PROTECTION</td> <td>1.000</td> <td>PC</td> </tr> </tbody> </table>	Code	Description	Qty	UOM	VL1315A1	ASM TANK BLOCK PUMPS DID	1.000	PC	VL1340A0	DID JG 10 M-M BYPASS CONNECTION	1.000	PC	VL1400A0	PARTIAL EDGE BENT DRAIN	1.000	PC	VL1407A1	DID PRESSURE REDUCER ASSEMBLY	1.000	PC	VM1802A0	DID TANKS FLAP PIN	1.000	PC	VM2039A0	DRAIN BEND FIXING RING	1.000	PC	VM2640A0	DRAIN PUMP PROTECTION	1.000	PC																																									
			Code	Description	Qty	UOM																																																																								
VL1315A1	ASM TANK BLOCK PUMPS DID	1.000	PC																																																																											
VL1340A0	DID JG 10 M-M BYPASS CONNECTION	1.000	PC																																																																											
VL1400A0	PARTIAL EDGE BENT DRAIN	1.000	PC																																																																											
VL1407A1	DID PRESSURE REDUCER ASSEMBLY	1.000	PC																																																																											
VM1802A0	DID TANKS FLAP PIN	1.000	PC																																																																											
VM2039A0	DRAIN BEND FIXING RING	1.000	PC																																																																											
VM2640A0	DRAIN PUMP PROTECTION	1.000	PC																																																																											
KVL1310A	COMPLETE CBX RECIRC TANK GROUP KIT	<table border="1"> <thead> <tr> <th>Code</th> <th>Description</th> <th>Qty</th> <th>UOM</th> </tr> </thead> <tbody> <tr> <td>0H5760A0</td> <td>CN1016 CAPACITOR COVER</td> <td>1.000</td> <td>PC</td> </tr> <tr> <td>0H6686A0</td> <td></td> <td>1.000</td> <td>PC</td> </tr> <tr> <td>CE2054A0</td> <td>DRAIN PUMP RAST 5 CABLE</td> <td>1.000</td> <td>PC</td> </tr> <tr> <td>CE2055A0</td> <td>CAVO RAST 5 POMPA RICIRCOLO</td> <td>1.000</td> <td>PC</td> </tr> <tr> <td>CN1016A0</td> <td>CE/UL 500V 2.5 µF CAPACITO</td> <td>1.000</td> <td>PC</td> </tr> <tr> <td>GN1400A0</td> <td>U-TRAP SEAL</td> <td>1.000</td> <td>PC</td> </tr> <tr> <td>PM1013A0</td> <td>240V 32W DRAIN PUMP</td> <td>1.000</td> <td>PC</td> </tr> <tr> <td>PM1018A0</td> <td>240V 100W RECYCLING PUMP</td> <td>1.000</td> <td>PC</td> </tr> <tr> <td>RC1019A0</td> <td>D=10 ELASTIC CLAMP</td> <td>2.000</td> <td>PC</td> </tr> <tr> <td>RC1046A0</td> <td>D10-16 H9 ST STEEL HOSE CLAMP</td> <td>1.000</td> <td>PC</td> </tr> <tr> <td>RC1360A0</td> <td>10 - 10 JG ELBOW FITTIN</td> <td>2.000</td> <td>PC</td> </tr> <tr> <td>RC1378A0</td> <td>HOSE CLAMP</td> <td>1.000</td> <td>PC</td> </tr> <tr> <td>RC1410A0</td> <td>ST STEEL HOSE CLAMP D16-27</td> <td>6.000</td> <td>PC</td> </tr> <tr> <td>SN1053A0</td> <td></td> <td>1.000</td> <td>PC</td> </tr> <tr> <td>SN1061A0</td> <td>D4x175MM NTC PROBE</td> <td>1.000</td> <td>PC</td> </tr> <tr> <td>TB3822A0</td> <td></td> <td>2.000</td> <td>PC</td> </tr> <tr> <td>TB4135A0</td> <td></td> <td>1.000</td> <td>PC</td> </tr> <tr> <td>TB4160A0</td> <td></td> <td>1.000</td> <td>PC</td> </tr> </tbody> </table>	Code	Description	Qty	UOM	0H5760A0	CN1016 CAPACITOR COVER	1.000	PC	0H6686A0		1.000	PC	CE2054A0	DRAIN PUMP RAST 5 CABLE	1.000	PC	CE2055A0	CAVO RAST 5 POMPA RICIRCOLO	1.000	PC	CN1016A0	CE/UL 500V 2.5 µF CAPACITO	1.000	PC	GN1400A0	U-TRAP SEAL	1.000	PC	PM1013A0	240V 32W DRAIN PUMP	1.000	PC	PM1018A0	240V 100W RECYCLING PUMP	1.000	PC	RC1019A0	D=10 ELASTIC CLAMP	2.000	PC	RC1046A0	D10-16 H9 ST STEEL HOSE CLAMP	1.000	PC	RC1360A0	10 - 10 JG ELBOW FITTIN	2.000	PC	RC1378A0	HOSE CLAMP	1.000	PC	RC1410A0	ST STEEL HOSE CLAMP D16-27	6.000	PC	SN1053A0		1.000	PC	SN1061A0	D4x175MM NTC PROBE	1.000	PC	TB3822A0		2.000	PC	TB4135A0		1.000	PC	TB4160A0		1.000	PC
Code	Description	Qty	UOM																																																																											
0H5760A0	CN1016 CAPACITOR COVER	1.000	PC																																																																											
0H6686A0		1.000	PC																																																																											
CE2054A0	DRAIN PUMP RAST 5 CABLE	1.000	PC																																																																											
CE2055A0	CAVO RAST 5 POMPA RICIRCOLO	1.000	PC																																																																											
CN1016A0	CE/UL 500V 2.5 µF CAPACITO	1.000	PC																																																																											
GN1400A0	U-TRAP SEAL	1.000	PC																																																																											
PM1013A0	240V 32W DRAIN PUMP	1.000	PC																																																																											
PM1018A0	240V 100W RECYCLING PUMP	1.000	PC																																																																											
RC1019A0	D=10 ELASTIC CLAMP	2.000	PC																																																																											
RC1046A0	D10-16 H9 ST STEEL HOSE CLAMP	1.000	PC																																																																											
RC1360A0	10 - 10 JG ELBOW FITTIN	2.000	PC																																																																											
RC1378A0	HOSE CLAMP	1.000	PC																																																																											
RC1410A0	ST STEEL HOSE CLAMP D16-27	6.000	PC																																																																											
SN1053A0		1.000	PC																																																																											
SN1061A0	D4x175MM NTC PROBE	1.000	PC																																																																											
TB3822A0		2.000	PC																																																																											
TB4135A0		1.000	PC																																																																											
TB4160A0		1.000	PC																																																																											



COMPONENT			SPARE PART																																																																		
Code	Description	Image	Code	Description	Kit components																																																																
RC1243A	Ø10F-Ø10M ELBOW CONNECTION + JG END KIT		KVL1310A	COMPLETE CBX RECIRC TANK GROUP KIT	<table border="1"> <thead> <tr> <th>Code</th> <th>Description</th> <th>Qty</th> <th>UOM</th> </tr> </thead> <tbody> <tr> <td>VI1103A0</td> <td>40X12 TBSP SCREW FOR PLASTIC</td> <td>9.000</td> <td>PC</td> </tr> <tr> <td>VI1220A1</td> <td>4,2x12 TCB SELF-TAPPING SCREW</td> <td>2.000</td> <td>PC</td> </tr> <tr> <td>VI1931A0</td> <td>M8x1.65 H4 CH13 ZINC PLATED NUT</td> <td>1.000</td> <td>PC</td> </tr> <tr> <td>VL1178A0</td> <td>EPDM O-RING INNER D 10.8 STRING 1.78</td> <td>2.000</td> <td>PC</td> </tr> <tr> <td>VL1315A1</td> <td>ASM TANK BLOCK PUMPS DID</td> <td>1.000</td> <td>PC</td> </tr> <tr> <td>VL1318A0</td> <td>SUPPORTO POMPA RICIRCOLO DI</td> <td>1.000</td> <td>PC</td> </tr> <tr> <td>VL1329A0</td> <td>D24-D16 FITTING</td> <td>1.000</td> <td>PC</td> </tr> <tr> <td>VL1332A0</td> <td>DID TANK CAP</td> <td>1.000</td> <td>PC</td> </tr> <tr> <td>VL1340A0</td> <td>DID JG 10 M-M BYPASS CONNECTION</td> <td>1.000</td> <td>PC</td> </tr> <tr> <td>VL1400A0</td> <td>PARTIAL EDGE BENT DRAIN</td> <td>1.000</td> <td>PC</td> </tr> <tr> <td>VL1407A1</td> <td>DID PRESSURE REDUCER ASSEMBLY</td> <td>1.000</td> <td>PC</td> </tr> <tr> <td>VM1794A0</td> <td>250x4.8 PA66 BLACK CLAMP</td> <td>1.000</td> <td>PC</td> </tr> <tr> <td>VM1802A0</td> <td>DID TANKS FLAP PIN</td> <td>1.000</td> <td>PC</td> </tr> <tr> <td>VM2039A0</td> <td>DRAIN BEND FIXING RING</td> <td>1.000</td> <td>PC</td> </tr> <tr> <td>VM2640A0</td> <td>DRAIN PUMP PROTECTION</td> <td>1.000</td> <td>PC</td> </tr> </tbody> </table>	Code	Description	Qty	UOM	VI1103A0	40X12 TBSP SCREW FOR PLASTIC	9.000	PC	VI1220A1	4,2x12 TCB SELF-TAPPING SCREW	2.000	PC	VI1931A0	M8x1.65 H4 CH13 ZINC PLATED NUT	1.000	PC	VL1178A0	EPDM O-RING INNER D 10.8 STRING 1.78	2.000	PC	VL1315A1	ASM TANK BLOCK PUMPS DID	1.000	PC	VL1318A0	SUPPORTO POMPA RICIRCOLO DI	1.000	PC	VL1329A0	D24-D16 FITTING	1.000	PC	VL1332A0	DID TANK CAP	1.000	PC	VL1340A0	DID JG 10 M-M BYPASS CONNECTION	1.000	PC	VL1400A0	PARTIAL EDGE BENT DRAIN	1.000	PC	VL1407A1	DID PRESSURE REDUCER ASSEMBLY	1.000	PC	VM1794A0	250x4.8 PA66 BLACK CLAMP	1.000	PC	VM1802A0	DID TANKS FLAP PIN	1.000	PC	VM2039A0	DRAIN BEND FIXING RING	1.000	PC	VM2640A0	DRAIN PUMP PROTECTION	1.000	PC
			Code	Description	Qty	UOM																																																															
VI1103A0	40X12 TBSP SCREW FOR PLASTIC	9.000	PC																																																																		
VI1220A1	4,2x12 TCB SELF-TAPPING SCREW	2.000	PC																																																																		
VI1931A0	M8x1.65 H4 CH13 ZINC PLATED NUT	1.000	PC																																																																		
VL1178A0	EPDM O-RING INNER D 10.8 STRING 1.78	2.000	PC																																																																		
VL1315A1	ASM TANK BLOCK PUMPS DID	1.000	PC																																																																		
VL1318A0	SUPPORTO POMPA RICIRCOLO DI	1.000	PC																																																																		
VL1329A0	D24-D16 FITTING	1.000	PC																																																																		
VL1332A0	DID TANK CAP	1.000	PC																																																																		
VL1340A0	DID JG 10 M-M BYPASS CONNECTION	1.000	PC																																																																		
VL1400A0	PARTIAL EDGE BENT DRAIN	1.000	PC																																																																		
VL1407A1	DID PRESSURE REDUCER ASSEMBLY	1.000	PC																																																																		
VM1794A0	250x4.8 PA66 BLACK CLAMP	1.000	PC																																																																		
VM1802A0	DID TANKS FLAP PIN	1.000	PC																																																																		
VM2039A0	DRAIN BEND FIXING RING	1.000	PC																																																																		
VM2640A0	DRAIN PUMP PROTECTION	1.000	PC																																																																		
KVL1163A	MINDMAPS INLET CONNECTING PIPE KIT	<table border="1"> <thead> <tr> <th>Code</th> <th>Description</th> <th>Qty</th> <th>UOM</th> </tr> </thead> <tbody> <tr> <td>0H8038A0</td> <td>MM REDUCER SUPPORT PLATE</td> <td>1.000</td> <td>PC</td> </tr> <tr> <td>0H8039A0</td> <td>MM COMPACT REDUCER SUPPORT PLATE</td> <td>1.000</td> <td>PC</td> </tr> <tr> <td>CH1026A0</td> <td>UNOX JOHN GUEST SPANNER D8-D10</td> <td>1.000</td> <td>PC</td> </tr> </tbody> </table>	Code	Description	Qty	UOM	0H8038A0	MM REDUCER SUPPORT PLATE	1.000	PC	0H8039A0	MM COMPACT REDUCER SUPPORT PLATE	1.000	PC	CH1026A0	UNOX JOHN GUEST SPANNER D8-D10	1.000	PC																																																			
Code	Description	Qty	UOM																																																																		
0H8038A0	MM REDUCER SUPPORT PLATE	1.000	PC																																																																		
0H8039A0	MM COMPACT REDUCER SUPPORT PLATE	1.000	PC																																																																		
CH1026A0	UNOX JOHN GUEST SPANNER D8-D10	1.000	PC																																																																		

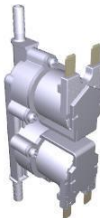
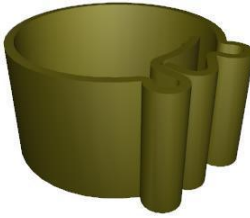

COMPONENT			SPARE PART																																						
Code	Description	Image	Code	Description	Kit components																																				
RC1243A	Ø10F-Ø10M ELBOW CONNECTION + JG END KIT		KVL1163A	MINDMAPS INLET CONNECTING PIPE KIT	<table border="1"> <thead> <tr> <th>Code</th> <th>Description</th> <th>Qty</th> <th>UOM</th> </tr> </thead> <tbody> <tr> <td>RC1243A0</td> <td>Ø10F-Ø10M ELBOW CONNECTION + JG END KIT</td> <td>2.000</td> <td>PC</td> </tr> <tr> <td>RC1396A0</td> <td>JG D10-1/4 STRAIGHT END FITTING</td> <td>2.000</td> <td>PC</td> </tr> <tr> <td>TB2243A0</td> <td>D10 PE TRANSPAREN T PIPE</td> <td>1.500</td> <td>M</td> </tr> <tr> <td>VI1220A1</td> <td>4,2X12 TCB SELF-TAPPIN G SCREW</td> <td>2.000</td> <td>PC</td> </tr> <tr> <td>VI1950A0</td> <td>ST. STEEL 4,2X13 TCB SELF-DRILLIN G SCREW</td> <td>1.000</td> <td>PC</td> </tr> <tr> <td>VL1014B3</td> <td>VL1014B3</td> <td>1.000</td> <td>PC</td> </tr> <tr> <td>VL1135A1</td> <td>3/4-JG10 CONNECTOR + FILTER AND NRV</td> <td>1.000</td> <td>PC</td> </tr> <tr> <td>VM1054A0</td> <td>H7.8 PRESSURE REDUCER RING NUT</td> <td>1.000</td> <td>PC</td> </tr> </tbody> </table>	Code	Description	Qty	UOM	RC1243A0	Ø10F-Ø10M ELBOW CONNECTION + JG END KIT	2.000	PC	RC1396A0	JG D10-1/4 STRAIGHT END FITTING	2.000	PC	TB2243A0	D10 PE TRANSPAREN T PIPE	1.500	M	VI1220A1	4,2X12 TCB SELF-TAPPIN G SCREW	2.000	PC	VI1950A0	ST. STEEL 4,2X13 TCB SELF-DRILLIN G SCREW	1.000	PC	VL1014B3	VL1014B3	1.000	PC	VL1135A1	3/4-JG10 CONNECTOR + FILTER AND NRV	1.000	PC	VM1054A0	H7.8 PRESSURE REDUCER RING NUT	1.000	PC
			Code	Description	Qty	UOM																																			
RC1243A0	Ø10F-Ø10M ELBOW CONNECTION + JG END KIT	2.000	PC																																						
RC1396A0	JG D10-1/4 STRAIGHT END FITTING	2.000	PC																																						
TB2243A0	D10 PE TRANSPAREN T PIPE	1.500	M																																						
VI1220A1	4,2X12 TCB SELF-TAPPIN G SCREW	2.000	PC																																						
VI1950A0	ST. STEEL 4,2X13 TCB SELF-DRILLIN G SCREW	1.000	PC																																						
VL1014B3	VL1014B3	1.000	PC																																						
VL1135A1	3/4-JG10 CONNECTOR + FILTER AND NRV	1.000	PC																																						
VM1054A0	H7.8 PRESSURE REDUCER RING NUT	1.000	PC																																						
KRC1243A	Ø10F-Ø10M ELBOW CONN + JG END 10 PCS KIT	<table border="1"> <thead> <tr> <th>Code</th> <th>Description</th> <th>Qty</th> <th>UOM</th> </tr> </thead> <tbody> <tr> <td>RC1243A0</td> <td>Ø10F-Ø10M ELBOW CONNECTION + JG END KIT</td> <td>10.000</td> <td>PC</td> </tr> </tbody> </table>	Code	Description	Qty	UOM	RC1243A0	Ø10F-Ø10M ELBOW CONNECTION + JG END KIT	10.000	PC																															
Code	Description	Qty	UOM																																						
RC1243A0	Ø10F-Ø10M ELBOW CONNECTION + JG END KIT	10.000	PC																																						
TB1099A	TB3130A-D10 WATER CONNECTING PIPE		KTB2599A	Ø10 PET WATER PIPE TB2243A0 100M KIT	<table border="1"> <thead> <tr> <th>Code</th> <th>Description</th> <th>Qty</th> <th>UOM</th> </tr> </thead> <tbody> <tr> <td>TB2243A0</td> <td>D10 PE TRANSPAREN T PIPE</td> <td>100.000</td> <td>M</td> </tr> </tbody> </table>	Code	Description	Qty	UOM	TB2243A0	D10 PE TRANSPAREN T PIPE	100.000	M																												
			Code	Description	Qty	UOM																																			
TB2243A0	D10 PE TRANSPAREN T PIPE	100.000	M																																						
KTB2598A	D10 PET HUMIDITY PIPE TB2243A0 3 M KIT	<table border="1"> <thead> <tr> <th>Code</th> <th>Description</th> <th>Qty</th> <th>UOM</th> </tr> </thead> <tbody> <tr> <td>TB2243A0</td> <td>D10 PE TRANSPAREN T PIPE</td> <td>3.000</td> <td>M</td> </tr> </tbody> </table>	Code	Description	Qty	UOM	TB2243A0	D10 PE TRANSPAREN T PIPE	3.000	M																															
Code	Description	Qty	UOM																																						
TB2243A0	D10 PE TRANSPAREN T PIPE	3.000	M																																						
VL1135A	3/4-JG10 CONNECTOR + FILTER AND NRV		KVL1135A	3/4-JG10 FITTING WITH FILTER AND VNR KIT	<table border="1"> <thead> <tr> <th>Code</th> <th>Description</th> <th>Qty</th> <th>UOM</th> </tr> </thead> <tbody> <tr> <td>RC1360A0</td> <td>10 - 10 JG ELBOW FITTIN</td> <td>1.000</td> <td>PC</td> </tr> <tr> <td>VL1135A1</td> <td>3/4-JG10 CONNECTOR + FILTER AND NRV</td> <td>1.000</td> <td>PC</td> </tr> </tbody> </table>	Code	Description	Qty	UOM	RC1360A0	10 - 10 JG ELBOW FITTIN	1.000	PC	VL1135A1	3/4-JG10 CONNECTOR + FILTER AND NRV	1.000	PC																								
Code	Description	Qty	UOM																																						
RC1360A0	10 - 10 JG ELBOW FITTIN	1.000	PC																																						
VL1135A1	3/4-JG10 CONNECTOR + FILTER AND NRV	1.000	PC																																						

COMPONENT			SPARE PART																														
Code	Description	Image	Code	Description	Kit components																												
TB3251A	TB3131A-H2O STEAM INLET PIPE		KTB3131A	WHITE-BLACK 6X12 STEAM PIPE 3M KIT	<table border="1"> <thead> <tr> <th>Code</th> <th>Description</th> <th>Qty</th> <th>UOM</th> </tr> </thead> <tbody> <tr> <td>TB3131A0</td> <td>WHITE-BLACK EPDM TEXTILE BRAID HOSE 6x12</td> <td>3.000</td> <td>M</td> </tr> <tr> <td>VM1794A0</td> <td>250x4.8 PA66 BLACK CLAMP</td> <td>1.000</td> <td>PC</td> </tr> </tbody> </table>	Code	Description	Qty	UOM	TB3131A0	WHITE-BLACK EPDM TEXTILE BRAID HOSE 6x12	3.000	M	VM1794A0	250x4.8 PA66 BLACK CLAMP	1.000	PC																
					Code	Description	Qty	UOM																									
TB3131A0	WHITE-BLACK EPDM TEXTILE BRAID HOSE 6x12	3.000	M																														
VM1794A0	250x4.8 PA66 BLACK CLAMP	1.000	PC																														
EL1430B	BARBED 5+21 STEAM SOLENOID VALVE		KEL1430B	5+21 6mm BARBED DUAL SOLENOID VALVE KIT	<table border="1"> <thead> <tr> <th>Code</th> <th>Description</th> <th>Qty</th> <th>UOM</th> </tr> </thead> <tbody> <tr> <td>EL1430B0</td> <td>BARBED 5+21 STEAM SOLENOID VALVE</td> <td>1.000</td> <td>PC</td> </tr> <tr> <td>RC1414A1</td> <td>D11.5-12.5 SINGLE EAR HOSE CLAMP</td> <td>2.000</td> <td>PC</td> </tr> </tbody> </table>	Code	Description	Qty	UOM	EL1430B0	BARBED 5+21 STEAM SOLENOID VALVE	1.000	PC	RC1414A1	D11.5-12.5 SINGLE EAR HOSE CLAMP	2.000	PC																
Code	Description	Qty	UOM																														
EL1430B0	BARBED 5+21 STEAM SOLENOID VALVE	1.000	PC																														
RC1414A1	D11.5-12.5 SINGLE EAR HOSE CLAMP	2.000	PC																														
RC1414A	D12 HOSE CLAMP		KRC1414A	D11-12 HOSE SNAP CLAMP 10 PCS KIT	<table border="1"> <thead> <tr> <th>Code</th> <th>Description</th> <th>Qty</th> <th>UOM</th> </tr> </thead> <tbody> <tr> <td>RC1414A1</td> <td>D11.5-12.5 SINGLE EAR HOSE CLAMP</td> <td>50.000</td> <td>PC</td> </tr> </tbody> </table>	Code	Description	Qty	UOM	RC1414A1	D11.5-12.5 SINGLE EAR HOSE CLAMP	50.000	PC																				
Code	Description	Qty	UOM																														
RC1414A1	D11.5-12.5 SINGLE EAR HOSE CLAMP	50.000	PC																														
TB3192A	TB3192A0		KTB3131A	WHITE-BLACK 6X12 STEAM PIPE 3M KIT	<table border="1"> <thead> <tr> <th>Code</th> <th>Description</th> <th>Qty</th> <th>UOM</th> </tr> </thead> <tbody> <tr> <td>TB3131A0</td> <td>WHITE-BLACK EPDM TEXTILE BRAID HOSE 6x12</td> <td>3.000</td> <td>M</td> </tr> <tr> <td>VM1794A0</td> <td>250x4.8 PA66 BLACK CLAMP</td> <td>1.000</td> <td>PC</td> </tr> </tbody> </table>	Code	Description	Qty	UOM	TB3131A0	WHITE-BLACK EPDM TEXTILE BRAID HOSE 6x12	3.000	M	VM1794A0	250x4.8 PA66 BLACK CLAMP	1.000	PC																
Code	Description	Qty	UOM																														
TB3131A0	WHITE-BLACK EPDM TEXTILE BRAID HOSE 6x12	3.000	M																														
VM1794A0	250x4.8 PA66 BLACK CLAMP	1.000	PC																														
VL1183A	EU PLUS 1 ROTOR ARM WASHING CIRCUIT		KVL1183A	1 ROTOR ARM PLUS CLEANING SYSTEM KIT	<table border="1"> <thead> <tr> <th>Code</th> <th>Description</th> <th>Qty</th> <th>UOM</th> </tr> </thead> <tbody> <tr> <td>0H2354A1</td> <td>XEVC-XEVL PLUS WASHING CIRCUIT PLAT</td> <td>1.000</td> <td>PC</td> </tr> <tr> <td>EL1440A0</td> <td>WATER SELF CLEANING VALVE</td> <td>3.000</td> <td>PC</td> </tr> <tr> <td>GN1526A0</td> <td>INT. D.=6.9 TH=1.8 O-RIN</td> <td>7.000</td> <td>PC</td> </tr> <tr> <td>RC1018A0</td> <td>ZINC PLATED D12 ELASTIC CLAMP</td> <td>1.000</td> <td>PC</td> </tr> <tr> <td>RC1019A0</td> <td>D=10 ELASTIC CLAMP</td> <td>12.000</td> <td>PC</td> </tr> <tr> <td>RC1130A0</td> <td>130x2,6 CLAM</td> <td>1.000</td> <td>PC</td> </tr> </tbody> </table>	Code	Description	Qty	UOM	0H2354A1	XEVC-XEVL PLUS WASHING CIRCUIT PLAT	1.000	PC	EL1440A0	WATER SELF CLEANING VALVE	3.000	PC	GN1526A0	INT. D.=6.9 TH=1.8 O-RIN	7.000	PC	RC1018A0	ZINC PLATED D12 ELASTIC CLAMP	1.000	PC	RC1019A0	D=10 ELASTIC CLAMP	12.000	PC	RC1130A0	130x2,6 CLAM	1.000	PC
Code	Description	Qty	UOM																														
0H2354A1	XEVC-XEVL PLUS WASHING CIRCUIT PLAT	1.000	PC																														
EL1440A0	WATER SELF CLEANING VALVE	3.000	PC																														
GN1526A0	INT. D.=6.9 TH=1.8 O-RIN	7.000	PC																														
RC1018A0	ZINC PLATED D12 ELASTIC CLAMP	1.000	PC																														
RC1019A0	D=10 ELASTIC CLAMP	12.000	PC																														
RC1130A0	130x2,6 CLAM	1.000	PC																														



COMPONENT			SPARE PART																																																																														
Code	Description	Image	Code	Description	Kit components																																																																												
VL1183A	EU PLUS 1 ROTOR ARM WASHING CIRCUIT		KVL1183A	1 ROTOR ARM PLUS CLEANING SYSTEM KIT	<table border="1"> <thead> <tr> <th>Code</th> <th>Description</th> <th>Qty</th> <th>UOM</th> </tr> </thead> <tbody> <tr> <td>RC1131A0</td> <td>200x2.6 BLACK CLAMP</td> <td>2.000</td> <td>PC</td> </tr> <tr> <td>RC1242A0</td> <td>D=10 CLOSED CAP</td> <td>2.000</td> <td>PC</td> </tr> <tr> <td>RC1356A0</td> <td>"STRAIGHT THREADED FEMALE END 8x1/4" BS</td> <td>1.000</td> <td>PC</td> </tr> <tr> <td>RC1414A1</td> <td>D11.5-12.5 SINGLE EAR HOSE CLAMP</td> <td>1.000</td> <td>PC</td> </tr> <tr> <td>TB2821A0</td> <td>EPDM 6X10 L=40MM PIPE</td> <td>4.000</td> <td>PC</td> </tr> <tr> <td>TB3004A0</td> <td>TB2820A L=550mm EPDM BLACK PIPE</td> <td>1.000</td> <td>PC</td> </tr> <tr> <td>TB3005B0</td> <td>TB3132A L=550mm EPDM WHITE-BLUE PIPE</td> <td>1.000</td> <td>PC</td> </tr> <tr> <td>TB3225B0</td> <td>TB2820A-TAN K-WASHYNG SYS CONNECTION</td> <td>1.000</td> <td>PC</td> </tr> <tr> <td>TB3252A0</td> <td>TB3252A0</td> <td>1.000</td> <td>PC</td> </tr> <tr> <td>TB3614A0</td> <td>TB3614A0</td> <td>1.000</td> <td>PC</td> </tr> <tr> <td>VH1220A1</td> <td>4,2x12 TCB SELF-TAPPIN G SCREW</td> <td>1.000</td> <td>PC</td> </tr> <tr> <td>VL1019A0</td> <td>VIBRATION DETERGENT PUMP</td> <td>1.000</td> <td>PC</td> </tr> <tr> <td>VL1047A1</td> <td>D6 PIPE HOLDER - D8 J.G. TERMINAL</td> <td>1.000</td> <td>PC</td> </tr> <tr> <td>VL1102A1</td> <td>DETERGENT LINE FILTER + BARBED VNR 6 MM</td> <td>1.000</td> <td>PC</td> </tr> <tr> <td>VL1128A1</td> <td>D6 BARBED CHECK VALVE</td> <td>1.000</td> <td>PC</td> </tr> <tr> <td>VL1166A0</td> <td>BB6-AR6 L FITTING</td> <td>3.000</td> <td>PC</td> </tr> <tr> <td>VL1174C0</td> <td>D1.2 MM CALIBRATED NOZZLE</td> <td>1.000</td> <td>PC</td> </tr> <tr> <td>VL1185A0</td> <td>2 WAYS PLUS WASHING DISTRIBUTOR</td> <td>1.000</td> <td>PC</td> </tr> </tbody> </table>	Code	Description	Qty	UOM	RC1131A0	200x2.6 BLACK CLAMP	2.000	PC	RC1242A0	D=10 CLOSED CAP	2.000	PC	RC1356A0	"STRAIGHT THREADED FEMALE END 8x1/4" BS	1.000	PC	RC1414A1	D11.5-12.5 SINGLE EAR HOSE CLAMP	1.000	PC	TB2821A0	EPDM 6X10 L=40MM PIPE	4.000	PC	TB3004A0	TB2820A L=550mm EPDM BLACK PIPE	1.000	PC	TB3005B0	TB3132A L=550mm EPDM WHITE-BLUE PIPE	1.000	PC	TB3225B0	TB2820A-TAN K-WASHYNG SYS CONNECTION	1.000	PC	TB3252A0	TB3252A0	1.000	PC	TB3614A0	TB3614A0	1.000	PC	VH1220A1	4,2x12 TCB SELF-TAPPIN G SCREW	1.000	PC	VL1019A0	VIBRATION DETERGENT PUMP	1.000	PC	VL1047A1	D6 PIPE HOLDER - D8 J.G. TERMINAL	1.000	PC	VL1102A1	DETERGENT LINE FILTER + BARBED VNR 6 MM	1.000	PC	VL1128A1	D6 BARBED CHECK VALVE	1.000	PC	VL1166A0	BB6-AR6 L FITTING	3.000	PC	VL1174C0	D1.2 MM CALIBRATED NOZZLE	1.000	PC	VL1185A0	2 WAYS PLUS WASHING DISTRIBUTOR	1.000	PC
					Code	Description	Qty	UOM																																																																									
					RC1131A0	200x2.6 BLACK CLAMP	2.000	PC																																																																									
					RC1242A0	D=10 CLOSED CAP	2.000	PC																																																																									
					RC1356A0	"STRAIGHT THREADED FEMALE END 8x1/4" BS	1.000	PC																																																																									
					RC1414A1	D11.5-12.5 SINGLE EAR HOSE CLAMP	1.000	PC																																																																									
					TB2821A0	EPDM 6X10 L=40MM PIPE	4.000	PC																																																																									
					TB3004A0	TB2820A L=550mm EPDM BLACK PIPE	1.000	PC																																																																									
					TB3005B0	TB3132A L=550mm EPDM WHITE-BLUE PIPE	1.000	PC																																																																									
					TB3225B0	TB2820A-TAN K-WASHYNG SYS CONNECTION	1.000	PC																																																																									
					TB3252A0	TB3252A0	1.000	PC																																																																									
					TB3614A0	TB3614A0	1.000	PC																																																																									
					VH1220A1	4,2x12 TCB SELF-TAPPIN G SCREW	1.000	PC																																																																									
					VL1019A0	VIBRATION DETERGENT PUMP	1.000	PC																																																																									
					VL1047A1	D6 PIPE HOLDER - D8 J.G. TERMINAL	1.000	PC																																																																									
					VL1102A1	DETERGENT LINE FILTER + BARBED VNR 6 MM	1.000	PC																																																																									
					VL1128A1	D6 BARBED CHECK VALVE	1.000	PC																																																																									
					VL1166A0	BB6-AR6 L FITTING	3.000	PC																																																																									
					VL1174C0	D1.2 MM CALIBRATED NOZZLE	1.000	PC																																																																									
					VL1185A0	2 WAYS PLUS WASHING DISTRIBUTOR	1.000	PC																																																																									



COMPONENT			SPARE PART																																																																						
Code	Description	Image	Code	Description	Kit components																																																																				
VL1183A	EU PLUS 1 ROTOR ARM WASHING CIRCUIT		KVL1183A	1 ROTOR ARM PLUS CLEANING SYSTEM KIT	<table border="1"> <thead> <tr> <th>Code</th> <th>Description</th> <th>Qty</th> <th>UOM</th> </tr> </thead> <tbody> <tr> <td>VL1190A0</td> <td>PLUS WASHING SYSTEM INLET DISTRIBUTOR</td> <td>1.000</td> <td>PC</td> </tr> <tr> <td>VL1214A0</td> <td>BAYONET - 6mm BARBED NRV VALVE</td> <td>1.000</td> <td>PC</td> </tr> <tr> <td>VL1398A0</td> <td>1/4 M N.O. CIL PRESSURE SWITCH</td> <td>1.000</td> <td>PC</td> </tr> <tr> <td>VM1605A0</td> <td>CLIP TWIST LOCK DIAM. 10,2-12,7 MM</td> <td>3.000</td> <td>PC</td> </tr> <tr> <td>VM2172A0</td> <td>LOCKING CLIP FOR PUMP WITH CIRCUIT</td> <td>4.000</td> <td>PC</td> </tr> </tbody> </table>	Code	Description	Qty	UOM	VL1190A0	PLUS WASHING SYSTEM INLET DISTRIBUTOR	1.000	PC	VL1214A0	BAYONET - 6mm BARBED NRV VALVE	1.000	PC	VL1398A0	1/4 M N.O. CIL PRESSURE SWITCH	1.000	PC	VM1605A0	CLIP TWIST LOCK DIAM. 10,2-12,7 MM	3.000	PC	VM2172A0	LOCKING CLIP FOR PUMP WITH CIRCUIT	4.000	PC																																												
Code	Description	Qty	UOM																																																																						
VL1190A0	PLUS WASHING SYSTEM INLET DISTRIBUTOR	1.000	PC																																																																						
VL1214A0	BAYONET - 6mm BARBED NRV VALVE	1.000	PC																																																																						
VL1398A0	1/4 M N.O. CIL PRESSURE SWITCH	1.000	PC																																																																						
VM1605A0	CLIP TWIST LOCK DIAM. 10,2-12,7 MM	3.000	PC																																																																						
VM2172A0	LOCKING CLIP FOR PUMP WITH CIRCUIT	4.000	PC																																																																						
0H2354A	XEVC-XEVL PLUS WASHING CIRCUIT PLATE		KVL1209A	US PLUS 3 ROTOR ARMS WASHING SYSTEM KIT	<table border="1"> <thead> <tr> <th>Code</th> <th>Description</th> <th>Qty</th> <th>UOM</th> </tr> </thead> <tbody> <tr> <td>0H2354A1</td> <td>XEVC-XEVL PLUS WASHING CIRCUIT PLAT</td> <td>1.000</td> <td>PC</td> </tr> <tr> <td>EL1450A0</td> <td>US SELF-CLEANING WATER SOLENOID</td> <td>4.000</td> <td>PC</td> </tr> <tr> <td>GN1526A0</td> <td>INT. D.=6.9 TH=1.8 O-RING</td> <td>9.000</td> <td>PC</td> </tr> <tr> <td>RC1018A0</td> <td>ZINC PLATED D12 ELASTIC CLAMP</td> <td>11.000</td> <td>PC</td> </tr> <tr> <td>RC1019A0</td> <td>D=10 ELASTIC CLAMP</td> <td>14.000</td> <td>PC</td> </tr> <tr> <td>RC1130A0</td> <td>130x2,6 CLAM</td> <td>1.000</td> <td>PC</td> </tr> <tr> <td>RC1131A0</td> <td>200x2,6 BLACK CLAMP</td> <td>3.000</td> <td>PC</td> </tr> <tr> <td>RC1242A0</td> <td>D=10 CLOSED CAP</td> <td>2.000</td> <td>PC</td> </tr> <tr> <td>RC1356A0</td> <td>"STRAIGHT THREADED FEMALE END 8x1/4" BS</td> <td>1.000</td> <td>PC</td> </tr> <tr> <td>RC1414A1</td> <td>D11.5-12.5 SINGLE EAR HOSE CLAMP</td> <td>1.000</td> <td>PC</td> </tr> <tr> <td>TB2652A0</td> <td></td> <td>1.000</td> <td>PC</td> </tr> <tr> <td>TB2677A0</td> <td></td> <td>1.000</td> <td>PC</td> </tr> <tr> <td>TB2821A0</td> <td>EPDM 6X10 L=40MM PIPE</td> <td>4.000</td> <td>PC</td> </tr> <tr> <td>TB3004A0</td> <td>TB2820A L=550mm EPDM BLACK PIPE</td> <td>2.000</td> <td>PC</td> </tr> <tr> <td>TB3024C0</td> <td></td> <td>3.000</td> <td>PC</td> </tr> <tr> <td>TB3226A0</td> <td></td> <td>1.000</td> <td>PC</td> </tr> </tbody> </table>	Code	Description	Qty	UOM	0H2354A1	XEVC-XEVL PLUS WASHING CIRCUIT PLAT	1.000	PC	EL1450A0	US SELF-CLEANING WATER SOLENOID	4.000	PC	GN1526A0	INT. D.=6.9 TH=1.8 O-RING	9.000	PC	RC1018A0	ZINC PLATED D12 ELASTIC CLAMP	11.000	PC	RC1019A0	D=10 ELASTIC CLAMP	14.000	PC	RC1130A0	130x2,6 CLAM	1.000	PC	RC1131A0	200x2,6 BLACK CLAMP	3.000	PC	RC1242A0	D=10 CLOSED CAP	2.000	PC	RC1356A0	"STRAIGHT THREADED FEMALE END 8x1/4" BS	1.000	PC	RC1414A1	D11.5-12.5 SINGLE EAR HOSE CLAMP	1.000	PC	TB2652A0		1.000	PC	TB2677A0		1.000	PC	TB2821A0	EPDM 6X10 L=40MM PIPE	4.000	PC	TB3004A0	TB2820A L=550mm EPDM BLACK PIPE	2.000	PC	TB3024C0		3.000	PC	TB3226A0		1.000	PC
Code	Description	Qty	UOM																																																																						
0H2354A1	XEVC-XEVL PLUS WASHING CIRCUIT PLAT	1.000	PC																																																																						
EL1450A0	US SELF-CLEANING WATER SOLENOID	4.000	PC																																																																						
GN1526A0	INT. D.=6.9 TH=1.8 O-RING	9.000	PC																																																																						
RC1018A0	ZINC PLATED D12 ELASTIC CLAMP	11.000	PC																																																																						
RC1019A0	D=10 ELASTIC CLAMP	14.000	PC																																																																						
RC1130A0	130x2,6 CLAM	1.000	PC																																																																						
RC1131A0	200x2,6 BLACK CLAMP	3.000	PC																																																																						
RC1242A0	D=10 CLOSED CAP	2.000	PC																																																																						
RC1356A0	"STRAIGHT THREADED FEMALE END 8x1/4" BS	1.000	PC																																																																						
RC1414A1	D11.5-12.5 SINGLE EAR HOSE CLAMP	1.000	PC																																																																						
TB2652A0		1.000	PC																																																																						
TB2677A0		1.000	PC																																																																						
TB2821A0	EPDM 6X10 L=40MM PIPE	4.000	PC																																																																						
TB3004A0	TB2820A L=550mm EPDM BLACK PIPE	2.000	PC																																																																						
TB3024C0		3.000	PC																																																																						
TB3226A0		1.000	PC																																																																						



COMPONENT			SPARE PART					
Code	Description	Image	Code	Description	Kit components			
0H2354A	XEVC-XEVL PLUS WASHING CIRCUIT PLATE		KVL1209A	US PLUS 3 ROTOR ARMS WASHING SYSTEM KIT	Code	Description	Qty	UOM
					TB3440A0	TB3132A L=1050mm EPDM WHITE-BLUE PIPE	1.000	PC
					TB3614A0	TB3614A0	1.000	PC
					VI1220A1	4,2x12 TCB SELF-TAPPIN G SCREW	1.000	PC
					VL1019A0	VIBRATION DETERGENT PUMP	1.000	PC
					VL1065A1	1/4 MALE N.O. PRESSURE SWITCH	1.000	PC
					VL1102A1	DETERGENT LINE FILTER + BARBED VNR 6 MM	1.000	PC
					VL1127A1	6mm BARBED T-SHAPED FITTING	2.000	PC
					VL1128A1	D6 BARBED CHECK VALVE	2.000	PC
					VL1166A0	BB6-AR6 L FITTING	4.000	PC
					VL1167A2	GN21 3 ROTOR ARMS B-B FLOW RESTRICTOR	1.000	PC
					VL1174C0	D1.2 MM CALIBRATED NOZZLE	1.000	PC
					VL1186A0	3 WAYS PLUS WASHING DISTRIBUTOR	1.000	PC
					VL1190A0	PLUS WASHING SYSTEM INLET DISTRIBUTOR	1.000	PC
					VL1214A0	BAYONET - 6mm BARBED NRV VALVE	1.000	PC
					VM1605A0	CLIP TWIST LOCK DIAM. 10,2-12,7 MM	3.000	PC
					VM2172A0	LOCKING CLIP FOR PUMP WITH CIRCUIT	5.000	PC



COMPONENT			SPARE PART					
Code	Description	Image	Code	Description	Kit components			
0H2354A	XEVC-XEVL PLUS WASHING CIRCUIT PLATE		KVL1208A	US PLUS 2 ROTOR ARMS WASHING SYSTEM KIT	Code	Description	Qty	UOM
					0H2354A1	XEVC-XEVL PLUS WASHING CIRCUIT PLAT	1.000	PC
					EL1450A0	US SELF-CLEANIN G WATER SOLENOID	4.000	PC
					GN1526A0	INT. D.=6.9 TH=1.8 O-RIN	9.000	PC
					RC1018A0	ZINC PLATED D12 ELASTIC CLAMP	3.000	PC
					RC1019A0	D=10 ELASTIC CLAMP	2.000	PC
					RC1130A0	130x2.6 CLAM	1.000	PC
					RC1131A0	200x2.6 BLACK CLAMP	3.000	PC
					RC1242A0	D=10 CLOSED CAP	2.000	PC
					RC1356A0	*STRAIGHT THREADED FEMALE END 8x1/4" BS	1.000	PC
					RC1414A1	D11.5-12.5 SINGLE EAR HOSE CLAMP	4.000	PC
					TB2821A0	EPDM 6X10 L=40MM PIPE	6.000	PC
					TB2994A0	HOOD DETERGENT PIPE	1.000	PC
					TB3004A0	TB2820A L=550mm EPDM BLACK PIPE	1.000	PC
					TB3005B0	TB3132A L=550mm EPDM WHITE-BLUE PIPE	1.000	PC
					TB3440A0	TB3132A L=1050mm EPDM WHITE-BLUE PIPE	1.000	PC
					VL1019A0	VIBRATION DETERGENT PUMP	1.000	PC
					VL1047A1	D6 PIPE HOLDER - D8 J.G. TERMINAL	1.000	PC
					VL1065A1	1/4 MALE N.O. PRESSURE SWITCH	1.000	PC



COMPONENT			SPARE PART																																														
Code	Description	Image	Code	Description	Kit components																																												
0H2354A	XEVC-XEVL PLUS WASHING CIRCUIT PLATE		KVL1208A	US PLUS 2 ROTOR ARMS WASHING SYSTEM KIT	<table border="1"> <thead> <tr> <th>Code</th> <th>Description</th> <th>Qty</th> <th>UOM</th> </tr> </thead> <tbody> <tr> <td>VL1102A1</td> <td>DETERGENT LINE FILTER + BARBED VNR 6 MM</td> <td>1.000</td> <td>PC</td> </tr> <tr> <td>VL1128A1</td> <td>D6 BARBED CHECK VALVE</td> <td>2.000</td> <td>PC</td> </tr> <tr> <td>VL1141A1</td> <td>BB6-BB6 STRAIGHT CONNECTION</td> <td>1.000</td> <td>PC</td> </tr> <tr> <td>VL1166A0</td> <td>BB6-AR6 L FITTING</td> <td>4.000</td> <td>PC</td> </tr> <tr> <td>VL1174C0</td> <td>D1.2 MM CALIBRATED NOZZLE</td> <td>1.000</td> <td>PC</td> </tr> <tr> <td>VL1186A0</td> <td>3 WAYS PLUS WASHING DISTRIBUTOR</td> <td>1.000</td> <td>PC</td> </tr> <tr> <td>VL1190A0</td> <td>PLUS WASHING SYSTEM INLET DISTRIBUTOR</td> <td>1.000</td> <td>PC</td> </tr> <tr> <td>VL1214A0</td> <td>BAYONET - 6mm BARBED NRV VALVE</td> <td>1.000</td> <td>PC</td> </tr> <tr> <td>VM1605A0</td> <td>CLIP TWIST LOCK DIAM. 10,2-12,7 MM</td> <td>3.000</td> <td>PC</td> </tr> <tr> <td>VM2172A0</td> <td>LOCKING CLIP FOR PUMP WITH CIRCUIT</td> <td>5.000</td> <td>PC</td> </tr> </tbody> </table>	Code	Description	Qty	UOM	VL1102A1	DETERGENT LINE FILTER + BARBED VNR 6 MM	1.000	PC	VL1128A1	D6 BARBED CHECK VALVE	2.000	PC	VL1141A1	BB6-BB6 STRAIGHT CONNECTION	1.000	PC	VL1166A0	BB6-AR6 L FITTING	4.000	PC	VL1174C0	D1.2 MM CALIBRATED NOZZLE	1.000	PC	VL1186A0	3 WAYS PLUS WASHING DISTRIBUTOR	1.000	PC	VL1190A0	PLUS WASHING SYSTEM INLET DISTRIBUTOR	1.000	PC	VL1214A0	BAYONET - 6mm BARBED NRV VALVE	1.000	PC	VM1605A0	CLIP TWIST LOCK DIAM. 10,2-12,7 MM	3.000	PC	VM2172A0	LOCKING CLIP FOR PUMP WITH CIRCUIT	5.000	PC
			Code	Description	Qty	UOM																																											
VL1102A1	DETERGENT LINE FILTER + BARBED VNR 6 MM	1.000	PC																																														
VL1128A1	D6 BARBED CHECK VALVE	2.000	PC																																														
VL1141A1	BB6-BB6 STRAIGHT CONNECTION	1.000	PC																																														
VL1166A0	BB6-AR6 L FITTING	4.000	PC																																														
VL1174C0	D1.2 MM CALIBRATED NOZZLE	1.000	PC																																														
VL1186A0	3 WAYS PLUS WASHING DISTRIBUTOR	1.000	PC																																														
VL1190A0	PLUS WASHING SYSTEM INLET DISTRIBUTOR	1.000	PC																																														
VL1214A0	BAYONET - 6mm BARBED NRV VALVE	1.000	PC																																														
VM1605A0	CLIP TWIST LOCK DIAM. 10,2-12,7 MM	3.000	PC																																														
VM2172A0	LOCKING CLIP FOR PUMP WITH CIRCUIT	5.000	PC																																														
KVL1207A	US PLUS 1 ROTOR ARM WASHING SYSTEM KIT	<table border="1"> <thead> <tr> <th>Code</th> <th>Description</th> <th>Qty</th> <th>UOM</th> </tr> </thead> <tbody> <tr> <td>0H2354A1</td> <td>XEVC-XEVL PLUS WASHING CIRCUIT PLAT</td> <td>1.000</td> <td>PC</td> </tr> <tr> <td>EL1450A0</td> <td>US SELF-CLEANING WATER SOLENOID</td> <td>3.000</td> <td>PC</td> </tr> <tr> <td>GN1526A0</td> <td>INT. D.=6.9 TH=1.8 O-RIN</td> <td>7.000</td> <td>PC</td> </tr> <tr> <td>RC1018A0</td> <td>ZINC PLATED D12 ELASTIC CLAMP</td> <td>1.000</td> <td>PC</td> </tr> <tr> <td>RC1019A0</td> <td>D=10 ELASTIC CLAMP</td> <td>12.000</td> <td>PC</td> </tr> <tr> <td>RC1130A0</td> <td>130x2.6 CLAM</td> <td>1.000</td> <td>PC</td> </tr> <tr> <td>RC1131A0</td> <td>200x2.6 BLACK CLAMP</td> <td>2.000</td> <td>PC</td> </tr> <tr> <td>RC1242A0</td> <td>D=10 CLOSED CAP</td> <td>2.000</td> <td>PC</td> </tr> </tbody> </table>	Code	Description	Qty	UOM	0H2354A1	XEVC-XEVL PLUS WASHING CIRCUIT PLAT	1.000	PC	EL1450A0	US SELF-CLEANING WATER SOLENOID	3.000	PC	GN1526A0	INT. D.=6.9 TH=1.8 O-RIN	7.000	PC	RC1018A0	ZINC PLATED D12 ELASTIC CLAMP	1.000	PC	RC1019A0	D=10 ELASTIC CLAMP	12.000	PC	RC1130A0	130x2.6 CLAM	1.000	PC	RC1131A0	200x2.6 BLACK CLAMP	2.000	PC	RC1242A0	D=10 CLOSED CAP	2.000	PC											
Code	Description	Qty	UOM																																														
0H2354A1	XEVC-XEVL PLUS WASHING CIRCUIT PLAT	1.000	PC																																														
EL1450A0	US SELF-CLEANING WATER SOLENOID	3.000	PC																																														
GN1526A0	INT. D.=6.9 TH=1.8 O-RIN	7.000	PC																																														
RC1018A0	ZINC PLATED D12 ELASTIC CLAMP	1.000	PC																																														
RC1019A0	D=10 ELASTIC CLAMP	12.000	PC																																														
RC1130A0	130x2.6 CLAM	1.000	PC																																														
RC1131A0	200x2.6 BLACK CLAMP	2.000	PC																																														
RC1242A0	D=10 CLOSED CAP	2.000	PC																																														



COMPONENT			SPARE PART																																																																														
Code	Description	Image	Code	Description	Kit components																																																																												
0H2354A	XEVC-XEVL PLUS WASHING CIRCUIT PLATE		KVL1207A	US PLUS 1 ROTOR ARM WASHING SYSTEM KIT	<table border="1"> <thead> <tr> <th>Code</th> <th>Description</th> <th>Qty</th> <th>UOM</th> </tr> </thead> <tbody> <tr> <td>RC1356A0</td> <td>"STRAIGHT THREADED FEMALE END 8x1/4" BS</td> <td>1.000</td> <td>PC</td> </tr> <tr> <td>RC1414A1</td> <td>D11.5-12.5 SINGLE EAR HOSE CLAMP</td> <td>5.000</td> <td>PC</td> </tr> <tr> <td>TB2821A0</td> <td>EPDM 6X10 L=40MM PIPE</td> <td>4.000</td> <td>PC</td> </tr> <tr> <td>TB3004A0</td> <td>TB2820A L=550mm EPDM BLACK PIPE</td> <td>1.000</td> <td>PC</td> </tr> <tr> <td>TB3005B0</td> <td>TB3132A L=550mm EPDM WHITE-BLUE PIPE</td> <td>2.000</td> <td>PC</td> </tr> <tr> <td>TB3024C0</td> <td></td> <td>1.000</td> <td>PC</td> </tr> <tr> <td>TB3225B0</td> <td>TB2820A-TAN K-WASHYNG SYS CONNECTION</td> <td>1.000</td> <td>PC</td> </tr> <tr> <td>TB3252A0</td> <td>TB3252A0</td> <td>1.000</td> <td>PC</td> </tr> <tr> <td>TB3614A0</td> <td>TB3614A0</td> <td>1.000</td> <td>PC</td> </tr> <tr> <td>VH1220A1</td> <td>4,2x12 TCB SELF-TAPPING SCREW</td> <td>1.000</td> <td>PC</td> </tr> <tr> <td>VL1019A0</td> <td>VIBRATION DETERGENT PUMP</td> <td>1.000</td> <td>PC</td> </tr> <tr> <td>VL1047A1</td> <td>D6 PIPE HOLDER - D8 J.G. TERMINAL</td> <td>1.000</td> <td>PC</td> </tr> <tr> <td>VL1102A1</td> <td>DETERGENT LINE FILTER + BARBED VNR 6 MM</td> <td>1.000</td> <td>PC</td> </tr> <tr> <td>VL1127A1</td> <td>6mm BARBED T-SHAPED FITTING</td> <td>1.000</td> <td>PC</td> </tr> <tr> <td>VL1128A1</td> <td>D6 BARBED CHECK VALVE</td> <td>1.000</td> <td>PC</td> </tr> <tr> <td>VL1166A0</td> <td>BB6-AR6 L FITTING</td> <td>3.000</td> <td>PC</td> </tr> <tr> <td>VL1174C0</td> <td>D1.2 MM CALIBRATED NOZZLE</td> <td>1.000</td> <td>PC</td> </tr> <tr> <td>VL1185A0</td> <td>2 WAYS PLUS WASHING DISTRIBUTOR</td> <td>1.000</td> <td>PC</td> </tr> </tbody> </table>	Code	Description	Qty	UOM	RC1356A0	"STRAIGHT THREADED FEMALE END 8x1/4" BS	1.000	PC	RC1414A1	D11.5-12.5 SINGLE EAR HOSE CLAMP	5.000	PC	TB2821A0	EPDM 6X10 L=40MM PIPE	4.000	PC	TB3004A0	TB2820A L=550mm EPDM BLACK PIPE	1.000	PC	TB3005B0	TB3132A L=550mm EPDM WHITE-BLUE PIPE	2.000	PC	TB3024C0		1.000	PC	TB3225B0	TB2820A-TAN K-WASHYNG SYS CONNECTION	1.000	PC	TB3252A0	TB3252A0	1.000	PC	TB3614A0	TB3614A0	1.000	PC	VH1220A1	4,2x12 TCB SELF-TAPPING SCREW	1.000	PC	VL1019A0	VIBRATION DETERGENT PUMP	1.000	PC	VL1047A1	D6 PIPE HOLDER - D8 J.G. TERMINAL	1.000	PC	VL1102A1	DETERGENT LINE FILTER + BARBED VNR 6 MM	1.000	PC	VL1127A1	6mm BARBED T-SHAPED FITTING	1.000	PC	VL1128A1	D6 BARBED CHECK VALVE	1.000	PC	VL1166A0	BB6-AR6 L FITTING	3.000	PC	VL1174C0	D1.2 MM CALIBRATED NOZZLE	1.000	PC	VL1185A0	2 WAYS PLUS WASHING DISTRIBUTOR	1.000	PC
					Code	Description	Qty	UOM																																																																									
					RC1356A0	"STRAIGHT THREADED FEMALE END 8x1/4" BS	1.000	PC																																																																									
					RC1414A1	D11.5-12.5 SINGLE EAR HOSE CLAMP	5.000	PC																																																																									
					TB2821A0	EPDM 6X10 L=40MM PIPE	4.000	PC																																																																									
					TB3004A0	TB2820A L=550mm EPDM BLACK PIPE	1.000	PC																																																																									
					TB3005B0	TB3132A L=550mm EPDM WHITE-BLUE PIPE	2.000	PC																																																																									
					TB3024C0		1.000	PC																																																																									
					TB3225B0	TB2820A-TAN K-WASHYNG SYS CONNECTION	1.000	PC																																																																									
					TB3252A0	TB3252A0	1.000	PC																																																																									
					TB3614A0	TB3614A0	1.000	PC																																																																									
					VH1220A1	4,2x12 TCB SELF-TAPPING SCREW	1.000	PC																																																																									
					VL1019A0	VIBRATION DETERGENT PUMP	1.000	PC																																																																									
					VL1047A1	D6 PIPE HOLDER - D8 J.G. TERMINAL	1.000	PC																																																																									
					VL1102A1	DETERGENT LINE FILTER + BARBED VNR 6 MM	1.000	PC																																																																									
					VL1127A1	6mm BARBED T-SHAPED FITTING	1.000	PC																																																																									
					VL1128A1	D6 BARBED CHECK VALVE	1.000	PC																																																																									
					VL1166A0	BB6-AR6 L FITTING	3.000	PC																																																																									
					VL1174C0	D1.2 MM CALIBRATED NOZZLE	1.000	PC																																																																									
					VL1185A0	2 WAYS PLUS WASHING DISTRIBUTOR	1.000	PC																																																																									



COMPONENT			SPARE PART																																																																			
Code	Description	Image	Code	Description	Kit components																																																																	
0H2354A	XEVC-XEVL PLUS WASHING CIRCUIT PLATE		KVL1207A	US PLUS 1 ROTOR ARM WASHING SYSTEM KIT	<table border="1"> <thead> <tr> <th>Code</th> <th>Description</th> <th>Qty</th> <th>UOM</th> </tr> </thead> <tbody> <tr> <td>VL1190A0</td> <td>PLUS WASHING SYSTEM INLET DISTRIBUTOR</td> <td>1.000</td> <td>PC</td> </tr> <tr> <td>VL1214A0</td> <td>BAYONET - 6mm BARBED NRV VALVE</td> <td>1.000</td> <td>PC</td> </tr> <tr> <td>VL1398A0</td> <td>1/4 M N.O. CIL PRESSURE SWITCH</td> <td>1.000</td> <td>PC</td> </tr> <tr> <td>VM1605A0</td> <td>CLIP TWIST LOCK DIAM. 10,2-12,7 MM</td> <td>3.000</td> <td>PC</td> </tr> <tr> <td>VM2172A0</td> <td>LOCKING CLIP FOR PUMP WITH CIRCUIT</td> <td>4.000</td> <td>PC</td> </tr> </tbody> </table>	Code	Description	Qty	UOM	VL1190A0	PLUS WASHING SYSTEM INLET DISTRIBUTOR	1.000	PC	VL1214A0	BAYONET - 6mm BARBED NRV VALVE	1.000	PC	VL1398A0	1/4 M N.O. CIL PRESSURE SWITCH	1.000	PC	VM1605A0	CLIP TWIST LOCK DIAM. 10,2-12,7 MM	3.000	PC	VM2172A0	LOCKING CLIP FOR PUMP WITH CIRCUIT	4.000	PC																																									
			Code	Description	Qty	UOM																																																																
VL1190A0	PLUS WASHING SYSTEM INLET DISTRIBUTOR	1.000	PC																																																																			
VL1214A0	BAYONET - 6mm BARBED NRV VALVE	1.000	PC																																																																			
VL1398A0	1/4 M N.O. CIL PRESSURE SWITCH	1.000	PC																																																																			
VM1605A0	CLIP TWIST LOCK DIAM. 10,2-12,7 MM	3.000	PC																																																																			
VM2172A0	LOCKING CLIP FOR PUMP WITH CIRCUIT	4.000	PC																																																																			
KVL1187A	3 ROTOR ARMS PLUS EU CLEANING SYSTEM KIT	<table border="1"> <thead> <tr> <th>Code</th> <th>Description</th> <th>Qty</th> <th>UOM</th> </tr> </thead> <tbody> <tr> <td>0H2354A1</td> <td>XEVC-XEVL PLUS WASHING CIRCUIT PLAT</td> <td>1.000</td> <td>PC</td> </tr> <tr> <td>EL1440A0</td> <td>WATER SELF CLEANING VALVE</td> <td>4.000</td> <td>PC</td> </tr> <tr> <td>GN1526A0</td> <td>INT. D.=6.9 TH=1.8 O-RIN</td> <td>9.000</td> <td>PC</td> </tr> <tr> <td>RC1018A0</td> <td>ZINC PLATED D12 ELASTIC CLAMP</td> <td>11.000</td> <td>PC</td> </tr> <tr> <td>RC1019A0</td> <td>D=10 ELASTIC CLAMP</td> <td>14.000</td> <td>PC</td> </tr> <tr> <td>RC1130A0</td> <td>130x2.6 CLAM</td> <td>1.000</td> <td>PC</td> </tr> <tr> <td>RC1131A0</td> <td>200x2.6 BLACK CLAMP</td> <td>3.000</td> <td>PC</td> </tr> <tr> <td>RC1242A0</td> <td>D=10 CLOSED CAP</td> <td>2.000</td> <td>PC</td> </tr> <tr> <td>RC1356A0</td> <td>"STRAIGHT THREADED FEMALE END 8x1/4" BS</td> <td>1.000</td> <td>PC</td> </tr> <tr> <td>RC1414A1</td> <td>D11.5-12.5 SINGLE EAR HOSE CLAMP</td> <td>1.000</td> <td>PC</td> </tr> <tr> <td>TB2652A0</td> <td></td> <td>1.000</td> <td>PC</td> </tr> <tr> <td>TB2677A0</td> <td></td> <td>1.000</td> <td>PC</td> </tr> <tr> <td>TB2821A0</td> <td>EPDM 6X10 L=40MM PIPE</td> <td>4.000</td> <td>PC</td> </tr> <tr> <td>TB3004A0</td> <td>TB2820A L=550mm EPDM BLACK PIPE</td> <td>2.000</td> <td>PC</td> </tr> <tr> <td>TB3024C0</td> <td></td> <td>3.000</td> <td>PC</td> </tr> <tr> <td>TB3226A0</td> <td></td> <td>1.000</td> <td>PC</td> </tr> </tbody> </table>	Code	Description	Qty	UOM	0H2354A1	XEVC-XEVL PLUS WASHING CIRCUIT PLAT	1.000	PC	EL1440A0	WATER SELF CLEANING VALVE	4.000	PC	GN1526A0	INT. D.=6.9 TH=1.8 O-RIN	9.000	PC	RC1018A0	ZINC PLATED D12 ELASTIC CLAMP	11.000	PC	RC1019A0	D=10 ELASTIC CLAMP	14.000	PC	RC1130A0	130x2.6 CLAM	1.000	PC	RC1131A0	200x2.6 BLACK CLAMP	3.000	PC	RC1242A0	D=10 CLOSED CAP	2.000	PC	RC1356A0	"STRAIGHT THREADED FEMALE END 8x1/4" BS	1.000	PC	RC1414A1	D11.5-12.5 SINGLE EAR HOSE CLAMP	1.000	PC	TB2652A0		1.000	PC	TB2677A0		1.000	PC	TB2821A0	EPDM 6X10 L=40MM PIPE	4.000	PC	TB3004A0	TB2820A L=550mm EPDM BLACK PIPE	2.000	PC	TB3024C0		3.000	PC	TB3226A0		1.000	PC
Code	Description	Qty	UOM																																																																			
0H2354A1	XEVC-XEVL PLUS WASHING CIRCUIT PLAT	1.000	PC																																																																			
EL1440A0	WATER SELF CLEANING VALVE	4.000	PC																																																																			
GN1526A0	INT. D.=6.9 TH=1.8 O-RIN	9.000	PC																																																																			
RC1018A0	ZINC PLATED D12 ELASTIC CLAMP	11.000	PC																																																																			
RC1019A0	D=10 ELASTIC CLAMP	14.000	PC																																																																			
RC1130A0	130x2.6 CLAM	1.000	PC																																																																			
RC1131A0	200x2.6 BLACK CLAMP	3.000	PC																																																																			
RC1242A0	D=10 CLOSED CAP	2.000	PC																																																																			
RC1356A0	"STRAIGHT THREADED FEMALE END 8x1/4" BS	1.000	PC																																																																			
RC1414A1	D11.5-12.5 SINGLE EAR HOSE CLAMP	1.000	PC																																																																			
TB2652A0		1.000	PC																																																																			
TB2677A0		1.000	PC																																																																			
TB2821A0	EPDM 6X10 L=40MM PIPE	4.000	PC																																																																			
TB3004A0	TB2820A L=550mm EPDM BLACK PIPE	2.000	PC																																																																			
TB3024C0		3.000	PC																																																																			
TB3226A0		1.000	PC																																																																			



COMPONENT			SPARE PART					
Code	Description	Image	Code	Description	Kit components			
0H2354A	XEVC-XEVL PLUS WASHING CIRCUIT PLATE		KVL1187A	3 ROTOR ARMS PLUS EU CLEANING SYSTEM KIT	Code	Description	Qty	UOM
					TB3440A0	TB3132A L=1050mm EPDM WHITE-BLUE PIPE	1.000	PC
					TB3614A0	TB3614A0	1.000	PC
					VI1220A1	4,2x12 TCB SELF-TAPPIN G SCREW	1.000	PC
					VL1019A0	VIBRATION DETERGENT PUMP	1.000	PC
					VL1047A1	D6 PIPE HOLDER - D8 J.G. TERMINAL	1.000	PC
					VL1065A1	1/4 MALE N.O. PRESSURE SWITCH	1.000	PC
					VL1102A1	DETERGENT LINE FILTER + BARBED VNR 6 MM	1.000	PC
					VL1127A1	6mm BARBED T-SHAPED FITTING	2.000	PC
					VL1128A1	D6 BARBED CHECK VALVE	2.000	PC
					VL1166A0	BB6-AR6 L FITTING	4.000	PC
					VL1167A2	GN21 3 ROTOR ARMS B-B FLOW RESTRICTOR	1.000	PC
					VL1174C0	D1.2 MM CALIBRATED NOZZLE	1.000	PC
					VL1186A0	3 WAYS PLUS WASHING DISTRIBUTOR	1.000	PC
					VL1190A0	PLUS WASHING SYSTEM INLET DISTRIBUTOR	1.000	PC
					VL1214A0	BAYONET - 6mm BARBED NRV VALVE	1.000	PC
					VM1605A0	CLIP TWIST LOCK DIAM. 10,2-12,7 MM	3.000	PC
					VM2172A0	LOCKING CLIP FOR PUMP WITH CIRCUIT	5.000	PC



COMPONENT			SPARE PART																																																																																		
Code	Description	Image	Code	Description	Kit components																																																																																
0H2354A	XEVC-XEVL PLUS WASHING CIRCUIT PLATE		KVL1184A	2 ROTOR ARMS PLUS EU CLEANING SYSTEM KIT	<table border="1"> <thead> <tr> <th>Code</th> <th>Description</th> <th>Qty</th> <th>UOM</th> </tr> </thead> <tbody> <tr> <td>0H2354A1</td> <td>XEVC-XEVL PLUS WASHING CIRCUIT PLAT</td> <td>1.000</td> <td>PC</td> </tr> <tr> <td>EL1440A0</td> <td>WATER SELF CLEANING VALVE</td> <td>4.000</td> <td>PC</td> </tr> <tr> <td>GN1526A0</td> <td>INT. D.=6.9 TH=1.8 O-RIN</td> <td>9.000</td> <td>PC</td> </tr> <tr> <td>RC1018A0</td> <td>ZINC PLATED D12 ELASTIC CLAMP</td> <td>2.000</td> <td>PC</td> </tr> <tr> <td>RC1019A0</td> <td>D=10 ELASTIC CLAMP</td> <td>13.000</td> <td>PC</td> </tr> <tr> <td>RC1130A0</td> <td>130x2.6 CLAM</td> <td>1.000</td> <td>PC</td> </tr> <tr> <td>RC1131A0</td> <td>200x2.6 BLACK CLAMP</td> <td>3.000</td> <td>PC</td> </tr> <tr> <td>RC1242A0</td> <td>D=10 CLOSED CAP</td> <td>2.000</td> <td>PC</td> </tr> <tr> <td>RC1356A0</td> <td>"STRAIGHT THREADED FEMALE END 8x1/4" BS</td> <td>1.000</td> <td>PC</td> </tr> <tr> <td>RC1414A1</td> <td>D11.5-12.5 SINGLE EAR HOSE CLAMP</td> <td>1.000</td> <td>PC</td> </tr> <tr> <td>TB2821A0</td> <td>EPDM 6X10 L=40MM PIPE</td> <td>4.000</td> <td>PC</td> </tr> <tr> <td>TB2994A0</td> <td>HOOD DETERGENT PIPE</td> <td>1.000</td> <td>PC</td> </tr> <tr> <td>TB3004A0</td> <td>TB2820A L=550mm EPDM BLACK PIPE</td> <td>2.000</td> <td>PC</td> </tr> <tr> <td>TB3005B0</td> <td>TB3132A L=550mm EPDM WHITE-BLUE PIPE</td> <td>1.000</td> <td>PC</td> </tr> <tr> <td>TB3440A0</td> <td>TB3132A L=1050mm EPDM WHITE-BLUE PIPE</td> <td>1.000</td> <td>PC</td> </tr> <tr> <td>TB3614A0</td> <td>TB3614A0</td> <td>1.000</td> <td>PC</td> </tr> <tr> <td>VH1220A1</td> <td>4,2x12 TCB SELF-TAPPIN G SCREW</td> <td>1.000</td> <td>PC</td> </tr> <tr> <td>VL1019A0</td> <td>VIBRATION DETERGENT PUMP</td> <td>1.000</td> <td>PC</td> </tr> <tr> <td>VL1047A1</td> <td>D6 PIPE HOLDER - D8 J.G. TERMINAL</td> <td>1.000</td> <td>PC</td> </tr> </tbody> </table>	Code	Description	Qty	UOM	0H2354A1	XEVC-XEVL PLUS WASHING CIRCUIT PLAT	1.000	PC	EL1440A0	WATER SELF CLEANING VALVE	4.000	PC	GN1526A0	INT. D.=6.9 TH=1.8 O-RIN	9.000	PC	RC1018A0	ZINC PLATED D12 ELASTIC CLAMP	2.000	PC	RC1019A0	D=10 ELASTIC CLAMP	13.000	PC	RC1130A0	130x2.6 CLAM	1.000	PC	RC1131A0	200x2.6 BLACK CLAMP	3.000	PC	RC1242A0	D=10 CLOSED CAP	2.000	PC	RC1356A0	"STRAIGHT THREADED FEMALE END 8x1/4" BS	1.000	PC	RC1414A1	D11.5-12.5 SINGLE EAR HOSE CLAMP	1.000	PC	TB2821A0	EPDM 6X10 L=40MM PIPE	4.000	PC	TB2994A0	HOOD DETERGENT PIPE	1.000	PC	TB3004A0	TB2820A L=550mm EPDM BLACK PIPE	2.000	PC	TB3005B0	TB3132A L=550mm EPDM WHITE-BLUE PIPE	1.000	PC	TB3440A0	TB3132A L=1050mm EPDM WHITE-BLUE PIPE	1.000	PC	TB3614A0	TB3614A0	1.000	PC	VH1220A1	4,2x12 TCB SELF-TAPPIN G SCREW	1.000	PC	VL1019A0	VIBRATION DETERGENT PUMP	1.000	PC	VL1047A1	D6 PIPE HOLDER - D8 J.G. TERMINAL	1.000	PC
Code	Description	Qty	UOM																																																																																		
0H2354A1	XEVC-XEVL PLUS WASHING CIRCUIT PLAT	1.000	PC																																																																																		
EL1440A0	WATER SELF CLEANING VALVE	4.000	PC																																																																																		
GN1526A0	INT. D.=6.9 TH=1.8 O-RIN	9.000	PC																																																																																		
RC1018A0	ZINC PLATED D12 ELASTIC CLAMP	2.000	PC																																																																																		
RC1019A0	D=10 ELASTIC CLAMP	13.000	PC																																																																																		
RC1130A0	130x2.6 CLAM	1.000	PC																																																																																		
RC1131A0	200x2.6 BLACK CLAMP	3.000	PC																																																																																		
RC1242A0	D=10 CLOSED CAP	2.000	PC																																																																																		
RC1356A0	"STRAIGHT THREADED FEMALE END 8x1/4" BS	1.000	PC																																																																																		
RC1414A1	D11.5-12.5 SINGLE EAR HOSE CLAMP	1.000	PC																																																																																		
TB2821A0	EPDM 6X10 L=40MM PIPE	4.000	PC																																																																																		
TB2994A0	HOOD DETERGENT PIPE	1.000	PC																																																																																		
TB3004A0	TB2820A L=550mm EPDM BLACK PIPE	2.000	PC																																																																																		
TB3005B0	TB3132A L=550mm EPDM WHITE-BLUE PIPE	1.000	PC																																																																																		
TB3440A0	TB3132A L=1050mm EPDM WHITE-BLUE PIPE	1.000	PC																																																																																		
TB3614A0	TB3614A0	1.000	PC																																																																																		
VH1220A1	4,2x12 TCB SELF-TAPPIN G SCREW	1.000	PC																																																																																		
VL1019A0	VIBRATION DETERGENT PUMP	1.000	PC																																																																																		
VL1047A1	D6 PIPE HOLDER - D8 J.G. TERMINAL	1.000	PC																																																																																		



COMPONENT			SPARE PART																																														
Code	Description	Image	Code	Description	Kit components																																												
0H2354A	XEVC-XEVL PLUS WASHING CIRCUIT PLATE		KVL1184A	2 ROTOR ARMS PLUS EU CLEANING SYSTEM KIT	<table border="1"> <thead> <tr> <th>Code</th> <th>Description</th> <th>Qty</th> <th>UOM</th> </tr> </thead> <tbody> <tr> <td>VL1065A1</td> <td>1/4 MALE N.O. PRESSURE SWITCH</td> <td>1.000</td> <td>PC</td> </tr> <tr> <td>VL1102A1</td> <td>DETERGENT LINE FILTER + BARBED VNR 6 MM</td> <td>1.000</td> <td>PC</td> </tr> <tr> <td>VL1128A1</td> <td>D6 BARBED CHECK VALVE</td> <td>1.000</td> <td>PC</td> </tr> <tr> <td>VL1166A0</td> <td>BB6-AR6 L FITTING</td> <td>4.000</td> <td>PC</td> </tr> <tr> <td>VL1174C0</td> <td>D1.2 MM CALIBRATED NOZZLE</td> <td>1.000</td> <td>PC</td> </tr> <tr> <td>VL1186A0</td> <td>3 WAYS PLUS WASHING DISTRIBUTOR</td> <td>1.000</td> <td>PC</td> </tr> <tr> <td>VL1190A0</td> <td>PLUS WASHING SYSTEM INLET DISTRIBUTOR</td> <td>1.000</td> <td>PC</td> </tr> <tr> <td>VL1214A0</td> <td>BAYONET - 6mm BARBED NRV VALVE</td> <td>1.000</td> <td>PC</td> </tr> <tr> <td>VM1605A0</td> <td>CLIP TWIST LOCK DIAM. 10,2-12,7 MM</td> <td>3.000</td> <td>PC</td> </tr> <tr> <td>VM2172A0</td> <td>LOCKING CLIP FOR PUMP WITH CIRCUIT</td> <td>5.000</td> <td>PC</td> </tr> </tbody> </table>	Code	Description	Qty	UOM	VL1065A1	1/4 MALE N.O. PRESSURE SWITCH	1.000	PC	VL1102A1	DETERGENT LINE FILTER + BARBED VNR 6 MM	1.000	PC	VL1128A1	D6 BARBED CHECK VALVE	1.000	PC	VL1166A0	BB6-AR6 L FITTING	4.000	PC	VL1174C0	D1.2 MM CALIBRATED NOZZLE	1.000	PC	VL1186A0	3 WAYS PLUS WASHING DISTRIBUTOR	1.000	PC	VL1190A0	PLUS WASHING SYSTEM INLET DISTRIBUTOR	1.000	PC	VL1214A0	BAYONET - 6mm BARBED NRV VALVE	1.000	PC	VM1605A0	CLIP TWIST LOCK DIAM. 10,2-12,7 MM	3.000	PC	VM2172A0	LOCKING CLIP FOR PUMP WITH CIRCUIT	5.000	PC
			Code	Description	Qty	UOM																																											
VL1065A1	1/4 MALE N.O. PRESSURE SWITCH	1.000	PC																																														
VL1102A1	DETERGENT LINE FILTER + BARBED VNR 6 MM	1.000	PC																																														
VL1128A1	D6 BARBED CHECK VALVE	1.000	PC																																														
VL1166A0	BB6-AR6 L FITTING	4.000	PC																																														
VL1174C0	D1.2 MM CALIBRATED NOZZLE	1.000	PC																																														
VL1186A0	3 WAYS PLUS WASHING DISTRIBUTOR	1.000	PC																																														
VL1190A0	PLUS WASHING SYSTEM INLET DISTRIBUTOR	1.000	PC																																														
VL1214A0	BAYONET - 6mm BARBED NRV VALVE	1.000	PC																																														
VM1605A0	CLIP TWIST LOCK DIAM. 10,2-12,7 MM	3.000	PC																																														
VM2172A0	LOCKING CLIP FOR PUMP WITH CIRCUIT	5.000	PC																																														
KVL1183A	1 ROTOR ARM PLUS CLEANING SYSTEM KIT	<table border="1"> <thead> <tr> <th>Code</th> <th>Description</th> <th>Qty</th> <th>UOM</th> </tr> </thead> <tbody> <tr> <td>0H2354A1</td> <td>XEVC-XEVL PLUS WASHING CIRCUIT PLAT</td> <td>1.000</td> <td>PC</td> </tr> <tr> <td>EL1440A0</td> <td>WATER SELF CLEANING VALVE</td> <td>3.000</td> <td>PC</td> </tr> <tr> <td>GN1526A0</td> <td>INT. D.=6.9 TH=1.8 O-RIN</td> <td>7.000</td> <td>PC</td> </tr> <tr> <td>RC1018A0</td> <td>ZINC PLATED D12 ELASTIC CLAMP</td> <td>1.000</td> <td>PC</td> </tr> <tr> <td>RC1019A0</td> <td>D=10 ELASTIC CLAMP</td> <td>12.000</td> <td>PC</td> </tr> <tr> <td>RC1130A0</td> <td>130x2.6 CLAM</td> <td>1.000</td> <td>PC</td> </tr> <tr> <td>RC1131A0</td> <td>200x2.6 BLACK CLAMP</td> <td>2.000</td> <td>PC</td> </tr> <tr> <td>RC1242A0</td> <td>D=10 CLOSED CAP</td> <td>2.000</td> <td>PC</td> </tr> </tbody> </table>	Code	Description	Qty	UOM	0H2354A1	XEVC-XEVL PLUS WASHING CIRCUIT PLAT	1.000	PC	EL1440A0	WATER SELF CLEANING VALVE	3.000	PC	GN1526A0	INT. D.=6.9 TH=1.8 O-RIN	7.000	PC	RC1018A0	ZINC PLATED D12 ELASTIC CLAMP	1.000	PC	RC1019A0	D=10 ELASTIC CLAMP	12.000	PC	RC1130A0	130x2.6 CLAM	1.000	PC	RC1131A0	200x2.6 BLACK CLAMP	2.000	PC	RC1242A0	D=10 CLOSED CAP	2.000	PC											
Code	Description	Qty	UOM																																														
0H2354A1	XEVC-XEVL PLUS WASHING CIRCUIT PLAT	1.000	PC																																														
EL1440A0	WATER SELF CLEANING VALVE	3.000	PC																																														
GN1526A0	INT. D.=6.9 TH=1.8 O-RIN	7.000	PC																																														
RC1018A0	ZINC PLATED D12 ELASTIC CLAMP	1.000	PC																																														
RC1019A0	D=10 ELASTIC CLAMP	12.000	PC																																														
RC1130A0	130x2.6 CLAM	1.000	PC																																														
RC1131A0	200x2.6 BLACK CLAMP	2.000	PC																																														
RC1242A0	D=10 CLOSED CAP	2.000	PC																																														



COMPONENT			SPARE PART																																																																														
Code	Description	Image	Code	Description	Kit components																																																																												
0H2354A	XEVC-XEVL PLUS WASHING CIRCUIT PLATE		KVL1183A	1 ROTOR ARM PLUS CLEANING SYSTEM KIT	<table border="1"> <thead> <tr> <th>Code</th> <th>Description</th> <th>Qty</th> <th>UOM</th> </tr> </thead> <tbody> <tr> <td>RC1356A0</td> <td>"STRAIGHT THREADED FEMALE END 8x1/4" BS</td> <td>1.000</td> <td>PC</td> </tr> <tr> <td>RC1414A1</td> <td>D11.5-12.5 SINGLE EAR HOSE CLAMP</td> <td>1.000</td> <td>PC</td> </tr> <tr> <td>TB2821A0</td> <td>EPDM 6X10 L=40MM PIPE</td> <td>4.000</td> <td>PC</td> </tr> <tr> <td>TB3004A0</td> <td>TB2820A L=550mm EPDM BLACK PIPE</td> <td>1.000</td> <td>PC</td> </tr> <tr> <td>TB3005B0</td> <td>TB3132A L=550mm EPDM WHITE-BLUE PIPE</td> <td>1.000</td> <td>PC</td> </tr> <tr> <td>TB3225B0</td> <td>TB2820A-TAN K-WASHYNG SYS CONNECTION</td> <td>1.000</td> <td>PC</td> </tr> <tr> <td>TB3252A0</td> <td>TB3252A0</td> <td>1.000</td> <td>PC</td> </tr> <tr> <td>TB3614A0</td> <td>TB3614A0</td> <td>1.000</td> <td>PC</td> </tr> <tr> <td>VI1220A1</td> <td>4,2x12 TCB SELF-TAPPIN G SCREW</td> <td>1.000</td> <td>PC</td> </tr> <tr> <td>VL1019A0</td> <td>VIBRATION DETERGENT PUMP</td> <td>1.000</td> <td>PC</td> </tr> <tr> <td>VL1047A1</td> <td>D6 PIPE HOLDER - D8 J.G. TERMINAL</td> <td>1.000</td> <td>PC</td> </tr> <tr> <td>VL1102A1</td> <td>DETERGENT LINE FILTER + BARBED VNR 6 MM</td> <td>1.000</td> <td>PC</td> </tr> <tr> <td>VL1128A1</td> <td>D6 BARBED CHECK VALVE</td> <td>1.000</td> <td>PC</td> </tr> <tr> <td>VL1166A0</td> <td>BB6-AR6 L FITTING</td> <td>3.000</td> <td>PC</td> </tr> <tr> <td>VL1174C0</td> <td>D1.2 MM CALIBRATED NOZZLE</td> <td>1.000</td> <td>PC</td> </tr> <tr> <td>VL1185A0</td> <td>2 WAYS PLUS WASHING DISTRIBUTOR</td> <td>1.000</td> <td>PC</td> </tr> <tr> <td>VL1190A0</td> <td>PLUS WASHING SYSTEM INLET DISTRIBUTOR</td> <td>1.000</td> <td>PC</td> </tr> <tr> <td>VL1214A0</td> <td>BAYONET - 6mm BARBED NRV VALVE</td> <td>1.000</td> <td>PC</td> </tr> </tbody> </table>	Code	Description	Qty	UOM	RC1356A0	"STRAIGHT THREADED FEMALE END 8x1/4" BS	1.000	PC	RC1414A1	D11.5-12.5 SINGLE EAR HOSE CLAMP	1.000	PC	TB2821A0	EPDM 6X10 L=40MM PIPE	4.000	PC	TB3004A0	TB2820A L=550mm EPDM BLACK PIPE	1.000	PC	TB3005B0	TB3132A L=550mm EPDM WHITE-BLUE PIPE	1.000	PC	TB3225B0	TB2820A-TAN K-WASHYNG SYS CONNECTION	1.000	PC	TB3252A0	TB3252A0	1.000	PC	TB3614A0	TB3614A0	1.000	PC	VI1220A1	4,2x12 TCB SELF-TAPPIN G SCREW	1.000	PC	VL1019A0	VIBRATION DETERGENT PUMP	1.000	PC	VL1047A1	D6 PIPE HOLDER - D8 J.G. TERMINAL	1.000	PC	VL1102A1	DETERGENT LINE FILTER + BARBED VNR 6 MM	1.000	PC	VL1128A1	D6 BARBED CHECK VALVE	1.000	PC	VL1166A0	BB6-AR6 L FITTING	3.000	PC	VL1174C0	D1.2 MM CALIBRATED NOZZLE	1.000	PC	VL1185A0	2 WAYS PLUS WASHING DISTRIBUTOR	1.000	PC	VL1190A0	PLUS WASHING SYSTEM INLET DISTRIBUTOR	1.000	PC	VL1214A0	BAYONET - 6mm BARBED NRV VALVE	1.000	PC
					Code	Description	Qty	UOM																																																																									
					RC1356A0	"STRAIGHT THREADED FEMALE END 8x1/4" BS	1.000	PC																																																																									
					RC1414A1	D11.5-12.5 SINGLE EAR HOSE CLAMP	1.000	PC																																																																									
					TB2821A0	EPDM 6X10 L=40MM PIPE	4.000	PC																																																																									
					TB3004A0	TB2820A L=550mm EPDM BLACK PIPE	1.000	PC																																																																									
					TB3005B0	TB3132A L=550mm EPDM WHITE-BLUE PIPE	1.000	PC																																																																									
					TB3225B0	TB2820A-TAN K-WASHYNG SYS CONNECTION	1.000	PC																																																																									
					TB3252A0	TB3252A0	1.000	PC																																																																									
					TB3614A0	TB3614A0	1.000	PC																																																																									
					VI1220A1	4,2x12 TCB SELF-TAPPIN G SCREW	1.000	PC																																																																									
					VL1019A0	VIBRATION DETERGENT PUMP	1.000	PC																																																																									
					VL1047A1	D6 PIPE HOLDER - D8 J.G. TERMINAL	1.000	PC																																																																									
					VL1102A1	DETERGENT LINE FILTER + BARBED VNR 6 MM	1.000	PC																																																																									
					VL1128A1	D6 BARBED CHECK VALVE	1.000	PC																																																																									
VL1166A0	BB6-AR6 L FITTING	3.000	PC																																																																														
VL1174C0	D1.2 MM CALIBRATED NOZZLE	1.000	PC																																																																														
VL1185A0	2 WAYS PLUS WASHING DISTRIBUTOR	1.000	PC																																																																														
VL1190A0	PLUS WASHING SYSTEM INLET DISTRIBUTOR	1.000	PC																																																																														
VL1214A0	BAYONET - 6mm BARBED NRV VALVE	1.000	PC																																																																														



COMPONENT			SPARE PART																		
Code	Description	Image	Code	Description	Kit components																
0H2354A	XEVC-XEVL PLUS WASHING CIRCUIT PLATE		KVL1183A	1 ROTOR ARM PLUS CLEANING SYSTEM KIT	<table border="1"> <thead> <tr> <th>Code</th> <th>Description</th> <th>Qty</th> <th>UOM</th> </tr> </thead> <tbody> <tr> <td>VL1398A0</td> <td>1/4 M N.O. CIL PRESSURE SWITCH</td> <td>1.000</td> <td>PC</td> </tr> <tr> <td>VM1605A0</td> <td>CLIP TWIST LOCK DIAM. 10,2-12,7 MM</td> <td>3.000</td> <td>PC</td> </tr> <tr> <td>VM2172A0</td> <td>LOCKING CLIP FOR PUMP WITH CIRCUIT</td> <td>4.000</td> <td>PC</td> </tr> </tbody> </table>	Code	Description	Qty	UOM	VL1398A0	1/4 M N.O. CIL PRESSURE SWITCH	1.000	PC	VM1605A0	CLIP TWIST LOCK DIAM. 10,2-12,7 MM	3.000	PC	VM2172A0	LOCKING CLIP FOR PUMP WITH CIRCUIT	4.000	PC
					Code	Description	Qty	UOM													
					VL1398A0	1/4 M N.O. CIL PRESSURE SWITCH	1.000	PC													
					VM1605A0	CLIP TWIST LOCK DIAM. 10,2-12,7 MM	3.000	PC													
VM2172A0	LOCKING CLIP FOR PUMP WITH CIRCUIT	4.000	PC																		
<table border="1"> <thead> <tr> <th>Code</th> <th>Description</th> <th>Qty</th> <th>UOM</th> </tr> </thead> <tbody> <tr> <td>GN1526A0</td> <td>INT. D.=6.9 TH=1.8 O-RING</td> <td>10.000</td> <td>PC</td> </tr> </tbody> </table>	Code	Description	Qty	UOM	GN1526A0	INT. D.=6.9 TH=1.8 O-RING	10.000	PC													
Code	Description	Qty	UOM																		
GN1526A0	INT. D.=6.9 TH=1.8 O-RING	10.000	PC																		
<table border="1"> <thead> <tr> <th>Code</th> <th>Description</th> <th>Qty</th> <th>UOM</th> </tr> </thead> <tbody> <tr> <td>KRC1019A0</td> <td>Ø10 ZINC PLATED ELASTIC CLAMP</td> <td>15.000</td> <td>PC</td> </tr> </tbody> </table>	Code	Description	Qty	UOM	KRC1019A0	Ø10 ZINC PLATED ELASTIC CLAMP	15.000	PC													
Code	Description	Qty	UOM																		
KRC1019A0	Ø10 ZINC PLATED ELASTIC CLAMP	15.000	PC																		
<table border="1"> <thead> <tr> <th>Code</th> <th>Description</th> <th>Qty</th> <th>UOM</th> </tr> </thead> <tbody> <tr> <td>KRC1242A0</td> <td>Ø10 CLOSED CONNECTION CAP</td> <td>20.000</td> <td>PC</td> </tr> </tbody> </table>	Code	Description	Qty	UOM	KRC1242A0	Ø10 CLOSED CONNECTION CAP	20.000	PC													
Code	Description	Qty	UOM																		
KRC1242A0	Ø10 CLOSED CONNECTION CAP	20.000	PC																		
GN1526A	INT. D.=6.9 TH=1.8 O-RING		KGN1526A	O-RING INT D6.9 THICK1.8 10PCS KIT	<table border="1"> <thead> <tr> <th>Code</th> <th>Description</th> <th>Qty</th> <th>UOM</th> </tr> </thead> <tbody> <tr> <td>GN1526A0</td> <td>INT. D.=6.9 TH=1.8 O-RIN</td> <td>10.000</td> <td>PC</td> </tr> </tbody> </table>	Code	Description	Qty	UOM	GN1526A0	INT. D.=6.9 TH=1.8 O-RIN	10.000	PC								
Code	Description	Qty	UOM																		
GN1526A0	INT. D.=6.9 TH=1.8 O-RIN	10.000	PC																		
RC1019A	D=10 ELASTIC CLAM		KRC1019A	Ø10 ZINC PLATED ELASTIC CLAMP 15 PCS KIT	<table border="1"> <thead> <tr> <th>Code</th> <th>Description</th> <th>Qty</th> <th>UOM</th> </tr> </thead> <tbody> <tr> <td>KRC1356A0</td> <td>"STRAIGHT THREADED FEMALE END 8x1/4" BS</td> <td>1.000</td> <td>PC</td> </tr> </tbody> </table>	Code	Description	Qty	UOM	KRC1356A0	"STRAIGHT THREADED FEMALE END 8x1/4" BS	1.000	PC								
Code	Description	Qty	UOM																		
KRC1356A0	"STRAIGHT THREADED FEMALE END 8x1/4" BS	1.000	PC																		
RC1242A	D=10 CLOSED CAP		KRC1242A	Ø10 CLOSED CONNECTION 20PCS KIT	<table border="1"> <thead> <tr> <th>Code</th> <th>Description</th> <th>Qty</th> <th>UOM</th> </tr> </thead> <tbody> <tr> <td>KRC1356A0</td> <td>"STRAIGHT THREADED FEMALE END 8x1/4" BS</td> <td>1.000</td> <td>PC</td> </tr> </tbody> </table>	Code	Description	Qty	UOM	KRC1356A0	"STRAIGHT THREADED FEMALE END 8x1/4" BS	1.000	PC								
Code	Description	Qty	UOM																		
KRC1356A0	"STRAIGHT THREADED FEMALE END 8x1/4" BS	1.000	PC																		
RC1356A	"STRAIGHT THREADED FEMALE END 8x1/4" BS		KRC1356A	STRAIGHT THREADED FEMALE END 8X1/4 BS	<table border="1"> <thead> <tr> <th>Code</th> <th>Description</th> <th>Qty</th> <th>UOM</th> </tr> </thead> <tbody> <tr> <td>KRC1356A0</td> <td>"STRAIGHT THREADED FEMALE END 8x1/4" BS</td> <td>1.000</td> <td>PC</td> </tr> </tbody> </table>	Code	Description	Qty	UOM	KRC1356A0	"STRAIGHT THREADED FEMALE END 8x1/4" BS	1.000	PC								
Code	Description	Qty	UOM																		
KRC1356A0	"STRAIGHT THREADED FEMALE END 8x1/4" BS	1.000	PC																		

COMPONENT			SPARE PART			
Code	Description	Image	Code	Description	Kit components	
VL1019A	VIBRATION DETERGENT PUMP		KVL2618A	2 ROTOR ARMS ONE CLEANING SYSTEM KIT	Code	Description Qty UOM
					0H2202A1	ONE 2.000 PC WASHING WITH STEAM VALVE SUPPORT
					CE1030A0	FEMALE 4.000 PC FASTON COVER 6.3X0.8 0,5-1mmg
					CE1395A0	6,3 X 0,8 2.000 PC IMALE FASTO
					CE1545A0	BLUE UNIP 2.000 M AWG18 ST.3135 WIRE
					CE1570A0	WHITE UNIP 2.000 M AWG18 ST.3135 WIRE
					CE1660A0	6,3x0,8 4.000 PC FEMALE FASTON COVE
					CE1661A0	MALE FASTON 2.000 PC COVER 6,3x0,8
					EL1020A1	D8 1.000 PC INTERMEDIAT E T-SHAPED FITTING
					EL1440A0	WATER SELF 2.000 PC CLEANING VALVE
					GN1526A0	INT. D.=6.9 6.000 PC TH=1.8 O-RIN
					RC1018A0	ZINC PLATED 2.000 PC D12 ELASTIC CLAMP
					RC1019A0	D=10 ELASTIC 28.000 PC CLAMP
					RC1130A0	130x2,6 CLAM 4.000 PC
					RC1242A0	D=10 CLOSED 4.000 PC CAP
					RC1414A1	D11.5-12.5 5.000 PC SINGLE EAR HOSE CLAMP
					TB2821A0	EPDM 6X10 12.000 PC L=40MM PIPE
					TB3004A0	TB2820A 2.000 PC L=550mm EPDM BLACK PIPE
					TB3009B0	TB3132A-ONE 2.000 PC OVEN WASHING INLET



COMPONENT			SPARE PART																																																																																					
Code	Description	Image	Code	Description	Kit components																																																																																			
VL1019A	VIBRATION DETERGENT PUMP		KVL2618A	2 ROTOR ARMS ONE CLEANING SYSTEM KIT	<table border="1"> <thead> <tr> <th>Code</th> <th>Description</th> <th>Qty</th> <th>UOM</th> </tr> </thead> <tbody> <tr> <td>TB3225B0</td> <td>TB2820A-TAN K-WASHYNG SYS CONNECTION</td> <td>2.000</td> <td>PC</td> </tr> <tr> <td>V11220A1</td> <td>4,2x12 TCB SELF-TAPPIN G SCREW</td> <td>2.000</td> <td>PC</td> </tr> <tr> <td>VL1019A0</td> <td>VIBRATION DETERGENT PUMP</td> <td>2.000</td> <td>PC</td> </tr> <tr> <td>VL1047A1</td> <td>D6 PIPE HOLDER - D8 J.G. TERMINAL</td> <td>2.000</td> <td>PC</td> </tr> <tr> <td>VL1054B0</td> <td>ONE WASHING SYS INLET DISTRIBUTOR</td> <td>2.000</td> <td>PC</td> </tr> <tr> <td>VL1102A1</td> <td>DETERGENT LINE FILTER + BARBED VNR 6 MM</td> <td>2.000</td> <td>PC</td> </tr> <tr> <td>VL1127A1</td> <td>6mm BARBED T-SHAPED FITTING</td> <td>1.000</td> <td>PC</td> </tr> <tr> <td>VL1128A1</td> <td>D6 BARBED CHECK VALVE</td> <td>4.000</td> <td>PC</td> </tr> <tr> <td>VL1166A0</td> <td>BB6-AR6 L FITTING</td> <td>2.000</td> <td>PC</td> </tr> <tr> <td>VL1174C0</td> <td>D1.2 MM CALIBRATED NOZZLE</td> <td>2.000</td> <td>PC</td> </tr> <tr> <td>VL1191A0</td> <td>ONE WASHING DISTRIBUTOR OUTLETS KIT</td> <td>2.000</td> <td>PC</td> </tr> <tr> <td>VL1214A0</td> <td>BAYONET - 6mm BARBED NRV VALVE</td> <td>2.000</td> <td>PC</td> </tr> <tr> <td>VM2172A0</td> <td>LOCKING CLIP FOR PUMP WITH CIRCUIT</td> <td>4.000</td> <td>PC</td> </tr> </tbody> </table>	Code	Description	Qty	UOM	TB3225B0	TB2820A-TAN K-WASHYNG SYS CONNECTION	2.000	PC	V11220A1	4,2x12 TCB SELF-TAPPIN G SCREW	2.000	PC	VL1019A0	VIBRATION DETERGENT PUMP	2.000	PC	VL1047A1	D6 PIPE HOLDER - D8 J.G. TERMINAL	2.000	PC	VL1054B0	ONE WASHING SYS INLET DISTRIBUTOR	2.000	PC	VL1102A1	DETERGENT LINE FILTER + BARBED VNR 6 MM	2.000	PC	VL1127A1	6mm BARBED T-SHAPED FITTING	1.000	PC	VL1128A1	D6 BARBED CHECK VALVE	4.000	PC	VL1166A0	BB6-AR6 L FITTING	2.000	PC	VL1174C0	D1.2 MM CALIBRATED NOZZLE	2.000	PC	VL1191A0	ONE WASHING DISTRIBUTOR OUTLETS KIT	2.000	PC	VL1214A0	BAYONET - 6mm BARBED NRV VALVE	2.000	PC	VM2172A0	LOCKING CLIP FOR PUMP WITH CIRCUIT	4.000	PC	KVL1225A	US HOOD WASHING SYSTEM KIT	<table border="1"> <thead> <tr> <th>Code</th> <th>Description</th> <th>Qty</th> <th>UOM</th> </tr> </thead> <tbody> <tr> <td>0H2213A1</td> <td>HOOD WATER CIRCUIT PLAT</td> <td>1.000</td> <td>PC</td> </tr> <tr> <td>EL1450A0</td> <td>US SELF-CLEANIN G WATER SOLENOID</td> <td>2.000</td> <td>PC</td> </tr> <tr> <td>GN1526A0</td> <td>INT. D.=6.9 TH=1.8 O-RIN</td> <td>5.000</td> <td>PC</td> </tr> <tr> <td>RC1019A0</td> <td>D=10 ELASTIC CLAMP</td> <td>14.000</td> <td>PC</td> </tr> <tr> <td>RC1131A0</td> <td>200x2.6 BLACK CLAMP</td> <td>1.000</td> <td>PC</td> </tr> </tbody> </table>	Code	Description	Qty	UOM	0H2213A1	HOOD WATER CIRCUIT PLAT	1.000	PC	EL1450A0	US SELF-CLEANIN G WATER SOLENOID	2.000	PC	GN1526A0	INT. D.=6.9 TH=1.8 O-RIN	5.000	PC	RC1019A0	D=10 ELASTIC CLAMP	14.000	PC	RC1131A0	200x2.6 BLACK CLAMP	1.000	PC
			Code	Description	Qty	UOM																																																																																		
TB3225B0	TB2820A-TAN K-WASHYNG SYS CONNECTION	2.000	PC																																																																																					
V11220A1	4,2x12 TCB SELF-TAPPIN G SCREW	2.000	PC																																																																																					
VL1019A0	VIBRATION DETERGENT PUMP	2.000	PC																																																																																					
VL1047A1	D6 PIPE HOLDER - D8 J.G. TERMINAL	2.000	PC																																																																																					
VL1054B0	ONE WASHING SYS INLET DISTRIBUTOR	2.000	PC																																																																																					
VL1102A1	DETERGENT LINE FILTER + BARBED VNR 6 MM	2.000	PC																																																																																					
VL1127A1	6mm BARBED T-SHAPED FITTING	1.000	PC																																																																																					
VL1128A1	D6 BARBED CHECK VALVE	4.000	PC																																																																																					
VL1166A0	BB6-AR6 L FITTING	2.000	PC																																																																																					
VL1174C0	D1.2 MM CALIBRATED NOZZLE	2.000	PC																																																																																					
VL1191A0	ONE WASHING DISTRIBUTOR OUTLETS KIT	2.000	PC																																																																																					
VL1214A0	BAYONET - 6mm BARBED NRV VALVE	2.000	PC																																																																																					
VM2172A0	LOCKING CLIP FOR PUMP WITH CIRCUIT	4.000	PC																																																																																					
Code	Description	Qty	UOM																																																																																					
0H2213A1	HOOD WATER CIRCUIT PLAT	1.000	PC																																																																																					
EL1450A0	US SELF-CLEANIN G WATER SOLENOID	2.000	PC																																																																																					
GN1526A0	INT. D.=6.9 TH=1.8 O-RIN	5.000	PC																																																																																					
RC1019A0	D=10 ELASTIC CLAMP	14.000	PC																																																																																					
RC1131A0	200x2.6 BLACK CLAMP	1.000	PC																																																																																					



COMPONENT			SPARE PART																																																																																		
Code	Description	Image	Code	Description	Kit components																																																																																
VL1019A	VIBRATION DETERGENT PUMP		KVL1225A	US HOOD WASHING SYSTEM KIT	<table border="1"> <thead> <tr> <th>Code</th> <th>Description</th> <th>Qty</th> <th>UOM</th> </tr> </thead> <tbody> <tr> <td>RC1242A0</td> <td>D=10 CLOSED CAP</td> <td>2.000</td> <td>PC</td> </tr> <tr> <td>RC1414A1</td> <td>D11.5-12.5 SINGLE EAR HOSE CLAMP</td> <td>4.000</td> <td>PC</td> </tr> <tr> <td>TB2821A0</td> <td>EPDM 6X10 L=40MM PIPE</td> <td>4.000</td> <td>PC</td> </tr> <tr> <td>TB2994A0</td> <td>HOOD DETERGENT PIPE</td> <td>2.000</td> <td>PC</td> </tr> <tr> <td>TB3252A0</td> <td>TB3252A0</td> <td>2.000</td> <td>PC</td> </tr> <tr> <td>TB3614A0</td> <td>TB3614A0</td> <td>1.000</td> <td>PC</td> </tr> <tr> <td>VI1220A1</td> <td>4,2x12 TCB SELF-TAPPIN G SCREW</td> <td>3.000</td> <td>PC</td> </tr> <tr> <td>VI2070A0</td> <td>SHEETTRACS TCB+ 40x8 SELF-THREAD SCREW</td> <td>2.000</td> <td>PC</td> </tr> <tr> <td>VL1019A0</td> <td>VIBRATION DETERGENT PUMP</td> <td>1.000</td> <td>PC</td> </tr> <tr> <td>VL1047A1</td> <td>D6 PIPE HOLDER - D8 J.G. TERMINAL</td> <td>1.000</td> <td>PC</td> </tr> <tr> <td>VL1054B0</td> <td>ONE WASHING SYS INLET DISTRIBUTOR</td> <td>1.000</td> <td>PC</td> </tr> <tr> <td>VL1102A1</td> <td>DETERGENT LINE FILTER + BARBED VNR 6 MM</td> <td>1.000</td> <td>PC</td> </tr> <tr> <td>VL1127A1</td> <td>6mm BARBED T-SHAPED FITTING</td> <td>1.000</td> <td>PC</td> </tr> <tr> <td>VL1128A1</td> <td>D6 BARBED CHECK VALVE</td> <td>1.000</td> <td>PC</td> </tr> <tr> <td>VL1165A0</td> <td>BAM-BB6 STRAIGHT FITTING</td> <td>1.000</td> <td>PC</td> </tr> <tr> <td>VL1166A0</td> <td>BB6-AR6 L FITTING</td> <td>2.000</td> <td>PC</td> </tr> <tr> <td>VL1174C0</td> <td>D1.2 MM CALIBRATED NOZZLE</td> <td>1.000</td> <td>PC</td> </tr> <tr> <td>VL1191A0</td> <td>ONE WASHING DISTRIBUTOR OUTLETS KIT</td> <td>1.000</td> <td>PC</td> </tr> <tr> <td>VL1214A0</td> <td>BAYONET - 6mm BARBED NRV VALVE</td> <td>1.000</td> <td>PC</td> </tr> </tbody> </table>	Code	Description	Qty	UOM	RC1242A0	D=10 CLOSED CAP	2.000	PC	RC1414A1	D11.5-12.5 SINGLE EAR HOSE CLAMP	4.000	PC	TB2821A0	EPDM 6X10 L=40MM PIPE	4.000	PC	TB2994A0	HOOD DETERGENT PIPE	2.000	PC	TB3252A0	TB3252A0	2.000	PC	TB3614A0	TB3614A0	1.000	PC	VI1220A1	4,2x12 TCB SELF-TAPPIN G SCREW	3.000	PC	VI2070A0	SHEETTRACS TCB+ 40x8 SELF-THREAD SCREW	2.000	PC	VL1019A0	VIBRATION DETERGENT PUMP	1.000	PC	VL1047A1	D6 PIPE HOLDER - D8 J.G. TERMINAL	1.000	PC	VL1054B0	ONE WASHING SYS INLET DISTRIBUTOR	1.000	PC	VL1102A1	DETERGENT LINE FILTER + BARBED VNR 6 MM	1.000	PC	VL1127A1	6mm BARBED T-SHAPED FITTING	1.000	PC	VL1128A1	D6 BARBED CHECK VALVE	1.000	PC	VL1165A0	BAM-BB6 STRAIGHT FITTING	1.000	PC	VL1166A0	BB6-AR6 L FITTING	2.000	PC	VL1174C0	D1.2 MM CALIBRATED NOZZLE	1.000	PC	VL1191A0	ONE WASHING DISTRIBUTOR OUTLETS KIT	1.000	PC	VL1214A0	BAYONET - 6mm BARBED NRV VALVE	1.000	PC
					Code	Description	Qty	UOM																																																																													
RC1242A0	D=10 CLOSED CAP	2.000	PC																																																																																		
RC1414A1	D11.5-12.5 SINGLE EAR HOSE CLAMP	4.000	PC																																																																																		
TB2821A0	EPDM 6X10 L=40MM PIPE	4.000	PC																																																																																		
TB2994A0	HOOD DETERGENT PIPE	2.000	PC																																																																																		
TB3252A0	TB3252A0	2.000	PC																																																																																		
TB3614A0	TB3614A0	1.000	PC																																																																																		
VI1220A1	4,2x12 TCB SELF-TAPPIN G SCREW	3.000	PC																																																																																		
VI2070A0	SHEETTRACS TCB+ 40x8 SELF-THREAD SCREW	2.000	PC																																																																																		
VL1019A0	VIBRATION DETERGENT PUMP	1.000	PC																																																																																		
VL1047A1	D6 PIPE HOLDER - D8 J.G. TERMINAL	1.000	PC																																																																																		
VL1054B0	ONE WASHING SYS INLET DISTRIBUTOR	1.000	PC																																																																																		
VL1102A1	DETERGENT LINE FILTER + BARBED VNR 6 MM	1.000	PC																																																																																		
VL1127A1	6mm BARBED T-SHAPED FITTING	1.000	PC																																																																																		
VL1128A1	D6 BARBED CHECK VALVE	1.000	PC																																																																																		
VL1165A0	BAM-BB6 STRAIGHT FITTING	1.000	PC																																																																																		
VL1166A0	BB6-AR6 L FITTING	2.000	PC																																																																																		
VL1174C0	D1.2 MM CALIBRATED NOZZLE	1.000	PC																																																																																		
VL1191A0	ONE WASHING DISTRIBUTOR OUTLETS KIT	1.000	PC																																																																																		
VL1214A0	BAYONET - 6mm BARBED NRV VALVE	1.000	PC																																																																																		





COMPONENT			SPARE PART																																																																			
Code	Description	Image	Code	Description	Kit components																																																																	
VL1019A	VIBRATION DETERGENT PUMP		KVL1225A	US HOOD WASHING SYSTEM KIT	<table border="1"> <thead> <tr> <th>Code</th> <th>Description</th> <th>Qty</th> <th>UOM</th> </tr> </thead> <tbody> <tr> <td>VM1605A0</td> <td>CLIP TWIST LOCK DIAM. 10,2-12,7 MM</td> <td>2.000</td> <td>PC</td> </tr> <tr> <td>VM2172A0</td> <td>LOCKING CLIP FOR PUMP WITH CIRCUIT</td> <td>3.000</td> <td>PC</td> </tr> </tbody> </table>	Code	Description	Qty	UOM	VM1605A0	CLIP TWIST LOCK DIAM. 10,2-12,7 MM	2.000	PC	VM2172A0	LOCKING CLIP FOR PUMP WITH CIRCUIT	3.000	PC																																																					
			Code	Description	Qty	UOM																																																																
VM1605A0	CLIP TWIST LOCK DIAM. 10,2-12,7 MM	2.000	PC																																																																			
VM2172A0	LOCKING CLIP FOR PUMP WITH CIRCUIT	3.000	PC																																																																			
KVL1222A	EUR 0311 ONE PLUS CLEANING SYSTEM KIT	<table border="1"> <thead> <tr> <th>Code</th> <th>Description</th> <th>Qty</th> <th>UOM</th> </tr> </thead> <tbody> <tr> <td>0H2486A0</td> <td>0311 WASHING CIRCUIT PLAT</td> <td>1.000</td> <td>PC</td> </tr> <tr> <td>EL1440A0</td> <td>WATER SELF CLEANING VALVE</td> <td>1.000</td> <td>PC</td> </tr> <tr> <td>GN1526A0</td> <td>INT. D.=6.9 TH=1.8 O-RIN</td> <td>3.000</td> <td>PC</td> </tr> <tr> <td>RC1019A0</td> <td>D=10 ELASTIC CLAMP</td> <td>12.000</td> <td>PC</td> </tr> <tr> <td>RC1242A0</td> <td>D=10 CLOSED CAP</td> <td>2.000</td> <td>PC</td> </tr> <tr> <td>RC1414A1</td> <td>D11.5-12.5 SINGLE EAR HOSE CLAMP</td> <td>1.000</td> <td>PC</td> </tr> <tr> <td>TB2821A0</td> <td>EPDM 6X10 L=40MM PIPE</td> <td>4.000</td> <td>PC</td> </tr> <tr> <td>TB3004A0</td> <td>TB2820A L=550mm EPDM BLACK PIPE</td> <td>1.000</td> <td>PC</td> </tr> <tr> <td>TB3009B0</td> <td>TB3132A-ONE OVEN WASHING INLET</td> <td>1.000</td> <td>PC</td> </tr> <tr> <td>TB3225B0</td> <td>TB2820A-TAN K-WASHYNG SYS CONNECTION</td> <td>1.000</td> <td>PC</td> </tr> <tr> <td>TB3614A0</td> <td>TB3614A0</td> <td>1.000</td> <td>PC</td> </tr> <tr> <td>VI1220A1</td> <td>4,2x12 TCB SELF-TAPPIN G SCREW</td> <td>4.000</td> <td>PC</td> </tr> <tr> <td>VI2070A0</td> <td>SHEETTRACS TCB+ 40x8 SELF-THREAD SCREW</td> <td>2.000</td> <td>PC</td> </tr> <tr> <td>VL1019A0</td> <td>VIBRATION DETERGENT PUMP</td> <td>1.000</td> <td>PC</td> </tr> <tr> <td>VL1047A1</td> <td>D6 PIPE HOLDER - D8 J.G. TERMINAL</td> <td>1.000</td> <td>PC</td> </tr> <tr> <td>VL1054B0</td> <td>ONE WASHING SYS INLET DISTRIBUTOR</td> <td>1.000</td> <td>PC</td> </tr> </tbody> </table>	Code	Description	Qty	UOM	0H2486A0	0311 WASHING CIRCUIT PLAT	1.000	PC	EL1440A0	WATER SELF CLEANING VALVE	1.000	PC	GN1526A0	INT. D.=6.9 TH=1.8 O-RIN	3.000	PC	RC1019A0	D=10 ELASTIC CLAMP	12.000	PC	RC1242A0	D=10 CLOSED CAP	2.000	PC	RC1414A1	D11.5-12.5 SINGLE EAR HOSE CLAMP	1.000	PC	TB2821A0	EPDM 6X10 L=40MM PIPE	4.000	PC	TB3004A0	TB2820A L=550mm EPDM BLACK PIPE	1.000	PC	TB3009B0	TB3132A-ONE OVEN WASHING INLET	1.000	PC	TB3225B0	TB2820A-TAN K-WASHYNG SYS CONNECTION	1.000	PC	TB3614A0	TB3614A0	1.000	PC	VI1220A1	4,2x12 TCB SELF-TAPPIN G SCREW	4.000	PC	VI2070A0	SHEETTRACS TCB+ 40x8 SELF-THREAD SCREW	2.000	PC	VL1019A0	VIBRATION DETERGENT PUMP	1.000	PC	VL1047A1	D6 PIPE HOLDER - D8 J.G. TERMINAL	1.000	PC	VL1054B0	ONE WASHING SYS INLET DISTRIBUTOR	1.000	PC
Code	Description	Qty	UOM																																																																			
0H2486A0	0311 WASHING CIRCUIT PLAT	1.000	PC																																																																			
EL1440A0	WATER SELF CLEANING VALVE	1.000	PC																																																																			
GN1526A0	INT. D.=6.9 TH=1.8 O-RIN	3.000	PC																																																																			
RC1019A0	D=10 ELASTIC CLAMP	12.000	PC																																																																			
RC1242A0	D=10 CLOSED CAP	2.000	PC																																																																			
RC1414A1	D11.5-12.5 SINGLE EAR HOSE CLAMP	1.000	PC																																																																			
TB2821A0	EPDM 6X10 L=40MM PIPE	4.000	PC																																																																			
TB3004A0	TB2820A L=550mm EPDM BLACK PIPE	1.000	PC																																																																			
TB3009B0	TB3132A-ONE OVEN WASHING INLET	1.000	PC																																																																			
TB3225B0	TB2820A-TAN K-WASHYNG SYS CONNECTION	1.000	PC																																																																			
TB3614A0	TB3614A0	1.000	PC																																																																			
VI1220A1	4,2x12 TCB SELF-TAPPIN G SCREW	4.000	PC																																																																			
VI2070A0	SHEETTRACS TCB+ 40x8 SELF-THREAD SCREW	2.000	PC																																																																			
VL1019A0	VIBRATION DETERGENT PUMP	1.000	PC																																																																			
VL1047A1	D6 PIPE HOLDER - D8 J.G. TERMINAL	1.000	PC																																																																			
VL1054B0	ONE WASHING SYS INLET DISTRIBUTOR	1.000	PC																																																																			



COMPONENT			SPARE PART																																																			
Code	Description	Image	Code	Description	Kit components																																																	
VL1019A	VIBRATION DETERGENT PUMP		KVL1222A	EUR 0311 ONE PLUS CLEANING SYSTEM KIT	<table border="1"> <thead> <tr> <th>Code</th> <th>Description</th> <th>Qty</th> <th>UOM</th> </tr> </thead> <tbody> <tr> <td>VL1102A1</td> <td>DETERGENT LINE FILTER + BARBED VNR 6 MM</td> <td>1.000</td> <td>PC</td> </tr> <tr> <td>VL1128A1</td> <td>D6 BARBED CHECK VALVE</td> <td>1.000</td> <td>PC</td> </tr> <tr> <td>VL1166A0</td> <td>BB6-AR6 L FITTING</td> <td>1.000</td> <td>PC</td> </tr> <tr> <td>VL1174C0</td> <td>D1.2 MM CALIBRATED NOZZLE</td> <td>1.000</td> <td>PC</td> </tr> <tr> <td>VL1191A0</td> <td>ONE WASHING DISTRIBUTOR OUTLETS KIT</td> <td>1.000</td> <td>PC</td> </tr> <tr> <td>VL1214A0</td> <td>BAYONET - 6mm BARBED NRV VALVE</td> <td>1.000</td> <td>PC</td> </tr> <tr> <td>VM2172A0</td> <td>LOCKING CLIP FOR PUMP WITH CIRCUIT</td> <td>2.000</td> <td>PC</td> </tr> </tbody> </table>	Code	Description	Qty	UOM	VL1102A1	DETERGENT LINE FILTER + BARBED VNR 6 MM	1.000	PC	VL1128A1	D6 BARBED CHECK VALVE	1.000	PC	VL1166A0	BB6-AR6 L FITTING	1.000	PC	VL1174C0	D1.2 MM CALIBRATED NOZZLE	1.000	PC	VL1191A0	ONE WASHING DISTRIBUTOR OUTLETS KIT	1.000	PC	VL1214A0	BAYONET - 6mm BARBED NRV VALVE	1.000	PC	VM2172A0	LOCKING CLIP FOR PUMP WITH CIRCUIT	2.000	PC																	
			Code	Description	Qty	UOM																																																
VL1102A1	DETERGENT LINE FILTER + BARBED VNR 6 MM	1.000	PC																																																			
VL1128A1	D6 BARBED CHECK VALVE	1.000	PC																																																			
VL1166A0	BB6-AR6 L FITTING	1.000	PC																																																			
VL1174C0	D1.2 MM CALIBRATED NOZZLE	1.000	PC																																																			
VL1191A0	ONE WASHING DISTRIBUTOR OUTLETS KIT	1.000	PC																																																			
VL1214A0	BAYONET - 6mm BARBED NRV VALVE	1.000	PC																																																			
VM2172A0	LOCKING CLIP FOR PUMP WITH CIRCUIT	2.000	PC																																																			
KVL1213A	US PLUS COMPACT WASHING SYSTEM KIT	<table border="1"> <thead> <tr> <th>Code</th> <th>Description</th> <th>Qty</th> <th>UOM</th> </tr> </thead> <tbody> <tr> <td>0H2428A2</td> <td>XECC PLUS WASHING CIRCUIT PLAT</td> <td>1.000</td> <td>PC</td> </tr> <tr> <td>EL1450A0</td> <td>US SELF-CLEANIN G WATER SOLENOID</td> <td>3.000</td> <td>PC</td> </tr> <tr> <td>GN1311A0</td> <td>RUBBER CABLE-PASSI NG De=25 Di=12 Th=6,5</td> <td>1.000</td> <td>PC</td> </tr> <tr> <td>GN1526A0</td> <td>INT. D.=6.9 TH=1.8 O-RIN</td> <td>7.000</td> <td>PC</td> </tr> <tr> <td>RC1018A0</td> <td>ZINC PLATED D12 ELASTIC CLAMP</td> <td>5.000</td> <td>PC</td> </tr> <tr> <td>RC1019A0</td> <td>D=10 ELASTIC CLAMP</td> <td>14.000</td> <td>PC</td> </tr> <tr> <td>RC1130A0</td> <td>130x2,6 CLAM</td> <td>1.000</td> <td>PC</td> </tr> <tr> <td>RC1131A0</td> <td>200x2,6 BLACK CLAMP</td> <td>1.000</td> <td>PC</td> </tr> <tr> <td>RC1242A0</td> <td>D=10 CLOSED CAP</td> <td>2.000</td> <td>PC</td> </tr> <tr> <td>RC1356A0</td> <td>"STRAIGHT THREADED FEMALE END 8x1/4" BS</td> <td>1.000</td> <td>PC</td> </tr> <tr> <td>RC1414A1</td> <td>D11.5-12.5 SINGLE EAR HOSE CLAMP</td> <td>4.000</td> <td>PC</td> </tr> <tr> <td>TB2821A0</td> <td>EPDM 6X10 L=40MM PIPE</td> <td>6.000</td> <td>PC</td> </tr> </tbody> </table>	Code	Description	Qty	UOM	0H2428A2	XECC PLUS WASHING CIRCUIT PLAT	1.000	PC	EL1450A0	US SELF-CLEANIN G WATER SOLENOID	3.000	PC	GN1311A0	RUBBER CABLE-PASSI NG De=25 Di=12 Th=6,5	1.000	PC	GN1526A0	INT. D.=6.9 TH=1.8 O-RIN	7.000	PC	RC1018A0	ZINC PLATED D12 ELASTIC CLAMP	5.000	PC	RC1019A0	D=10 ELASTIC CLAMP	14.000	PC	RC1130A0	130x2,6 CLAM	1.000	PC	RC1131A0	200x2,6 BLACK CLAMP	1.000	PC	RC1242A0	D=10 CLOSED CAP	2.000	PC	RC1356A0	"STRAIGHT THREADED FEMALE END 8x1/4" BS	1.000	PC	RC1414A1	D11.5-12.5 SINGLE EAR HOSE CLAMP	4.000	PC	TB2821A0	EPDM 6X10 L=40MM PIPE	6.000	PC
Code	Description	Qty	UOM																																																			
0H2428A2	XECC PLUS WASHING CIRCUIT PLAT	1.000	PC																																																			
EL1450A0	US SELF-CLEANIN G WATER SOLENOID	3.000	PC																																																			
GN1311A0	RUBBER CABLE-PASSI NG De=25 Di=12 Th=6,5	1.000	PC																																																			
GN1526A0	INT. D.=6.9 TH=1.8 O-RIN	7.000	PC																																																			
RC1018A0	ZINC PLATED D12 ELASTIC CLAMP	5.000	PC																																																			
RC1019A0	D=10 ELASTIC CLAMP	14.000	PC																																																			
RC1130A0	130x2,6 CLAM	1.000	PC																																																			
RC1131A0	200x2,6 BLACK CLAMP	1.000	PC																																																			
RC1242A0	D=10 CLOSED CAP	2.000	PC																																																			
RC1356A0	"STRAIGHT THREADED FEMALE END 8x1/4" BS	1.000	PC																																																			
RC1414A1	D11.5-12.5 SINGLE EAR HOSE CLAMP	4.000	PC																																																			
TB2821A0	EPDM 6X10 L=40MM PIPE	6.000	PC																																																			



COMPONENT			SPARE PART																																																																										
Code	Description	Image	Code	Description	Kit components																																																																								
VL1019A	VIBRATION DETERGENT PUMP		KVL1213A	US PLUS COMPACT WASHING SYSTEM KIT	<table border="1"> <thead> <tr> <th>Code</th> <th>Description</th> <th>Qty</th> <th>UOM</th> </tr> </thead> <tbody> <tr> <td>TB3004A0</td> <td>TB2820A L=550mm EPDM BLACK PIPE</td> <td>2.000</td> <td>PC</td> </tr> <tr> <td>TB3005B0</td> <td>TB3132A L=550mm EPDM WHITE-BLUE PIPE</td> <td>1.000</td> <td>PC</td> </tr> <tr> <td>TB3252A0</td> <td>TB3252A0</td> <td>1.000</td> <td>PC</td> </tr> <tr> <td>TB3469A0</td> <td></td> <td>1.000</td> <td>PC</td> </tr> <tr> <td>VI1220A1</td> <td>4,2x12 TCB SELF-TAPPIN G SCREW</td> <td>3.000</td> <td>PC</td> </tr> <tr> <td>VL1019A0</td> <td>VIBRATION DETERGENT PUMP</td> <td>1.000</td> <td>PC</td> </tr> <tr> <td>VL1047A1</td> <td>D6 PIPE HOLDER - D8 J.G. TERMINAL</td> <td>1.000</td> <td>PC</td> </tr> <tr> <td>VL1054B0</td> <td>ONE WASHING SYS INLET DISTRIBUTOR</td> <td>1.000</td> <td>PC</td> </tr> <tr> <td>VL1065A1</td> <td>1/4 MALE N.O. PRESSURE SWITCH</td> <td>1.000</td> <td>PC</td> </tr> <tr> <td>VL1102A1</td> <td>DETERGENT LINE FILTER + BARBED VNR 6 MM</td> <td>1.000</td> <td>PC</td> </tr> <tr> <td>VL1127A1</td> <td>6mm BARBED T-SHAPED FITTING</td> <td>1.000</td> <td>PC</td> </tr> <tr> <td>VL1128A1</td> <td>D6 BARBED CHECK VALVE</td> <td>2.000</td> <td>PC</td> </tr> <tr> <td>VL1165A0</td> <td>BAM-BB6 STRAIGHT FITTING</td> <td>1.000</td> <td>PC</td> </tr> <tr> <td>VL1166A0</td> <td>BB6-AR6 L FITTING</td> <td>3.000</td> <td>PC</td> </tr> <tr> <td>VL1174C0</td> <td>D1.2 MM CALIBRATED NOZZLE</td> <td>1.000</td> <td>PC</td> </tr> <tr> <td>VL1185A0</td> <td>2 WAYS PLUS WASHING DISTRIBUTOR</td> <td>1.000</td> <td>PC</td> </tr> <tr> <td>VM2172A0</td> <td>LOCKING CLIP FOR PUMP WITH CIRCUIT</td> <td>3.000</td> <td>PC</td> </tr> </tbody> </table>	Code	Description	Qty	UOM	TB3004A0	TB2820A L=550mm EPDM BLACK PIPE	2.000	PC	TB3005B0	TB3132A L=550mm EPDM WHITE-BLUE PIPE	1.000	PC	TB3252A0	TB3252A0	1.000	PC	TB3469A0		1.000	PC	VI1220A1	4,2x12 TCB SELF-TAPPIN G SCREW	3.000	PC	VL1019A0	VIBRATION DETERGENT PUMP	1.000	PC	VL1047A1	D6 PIPE HOLDER - D8 J.G. TERMINAL	1.000	PC	VL1054B0	ONE WASHING SYS INLET DISTRIBUTOR	1.000	PC	VL1065A1	1/4 MALE N.O. PRESSURE SWITCH	1.000	PC	VL1102A1	DETERGENT LINE FILTER + BARBED VNR 6 MM	1.000	PC	VL1127A1	6mm BARBED T-SHAPED FITTING	1.000	PC	VL1128A1	D6 BARBED CHECK VALVE	2.000	PC	VL1165A0	BAM-BB6 STRAIGHT FITTING	1.000	PC	VL1166A0	BB6-AR6 L FITTING	3.000	PC	VL1174C0	D1.2 MM CALIBRATED NOZZLE	1.000	PC	VL1185A0	2 WAYS PLUS WASHING DISTRIBUTOR	1.000	PC	VM2172A0	LOCKING CLIP FOR PUMP WITH CIRCUIT	3.000	PC
Code	Description	Qty	UOM																																																																										
TB3004A0	TB2820A L=550mm EPDM BLACK PIPE	2.000	PC																																																																										
TB3005B0	TB3132A L=550mm EPDM WHITE-BLUE PIPE	1.000	PC																																																																										
TB3252A0	TB3252A0	1.000	PC																																																																										
TB3469A0		1.000	PC																																																																										
VI1220A1	4,2x12 TCB SELF-TAPPIN G SCREW	3.000	PC																																																																										
VL1019A0	VIBRATION DETERGENT PUMP	1.000	PC																																																																										
VL1047A1	D6 PIPE HOLDER - D8 J.G. TERMINAL	1.000	PC																																																																										
VL1054B0	ONE WASHING SYS INLET DISTRIBUTOR	1.000	PC																																																																										
VL1065A1	1/4 MALE N.O. PRESSURE SWITCH	1.000	PC																																																																										
VL1102A1	DETERGENT LINE FILTER + BARBED VNR 6 MM	1.000	PC																																																																										
VL1127A1	6mm BARBED T-SHAPED FITTING	1.000	PC																																																																										
VL1128A1	D6 BARBED CHECK VALVE	2.000	PC																																																																										
VL1165A0	BAM-BB6 STRAIGHT FITTING	1.000	PC																																																																										
VL1166A0	BB6-AR6 L FITTING	3.000	PC																																																																										
VL1174C0	D1.2 MM CALIBRATED NOZZLE	1.000	PC																																																																										
VL1185A0	2 WAYS PLUS WASHING DISTRIBUTOR	1.000	PC																																																																										
VM2172A0	LOCKING CLIP FOR PUMP WITH CIRCUIT	3.000	PC																																																																										

COMPONENT			SPARE PART																																																																																									
Code	Description	Image	Code	Description	Kit components																																																																																							
VL1019A	VIBRATION DETERGENT PUMP		KVL1212A	EUR COMPACT PLUS CLEANING SYSTEM KIT	<table border="1"> <thead> <tr> <th>Code</th> <th>Description</th> <th>Qty</th> <th>UOM</th> </tr> </thead> <tbody> <tr> <td>0H2428A2</td> <td>XECC PLUS WASHING CIRCUIT PLAT</td> <td>1.000</td> <td>PC</td> </tr> <tr> <td>EL1440A0</td> <td>WATER SELF CLEANING VALVE</td> <td>3.000</td> <td>PC</td> </tr> <tr> <td>GN1311A0</td> <td>RUBBER CABLE-PASSI NG Dø=25 Di=12 Th=6,5</td> <td>1.000</td> <td>PC</td> </tr> <tr> <td>GN1526A0</td> <td>INT. D.=6.9 TH=1.8 O-RIN</td> <td>7.000</td> <td>PC</td> </tr> <tr> <td>RC1018A0</td> <td>ZINC PLATED D12 ELASTIC CLAMP</td> <td>5.000</td> <td>PC</td> </tr> <tr> <td>RC1019A0</td> <td>D=10 ELASTIC CLAMP</td> <td>14.000</td> <td>PC</td> </tr> <tr> <td>RC1130A0</td> <td>130x2,6 CLAM</td> <td>1.000</td> <td>PC</td> </tr> <tr> <td>RC1131A0</td> <td>200x2,6 BLACK CLAMP</td> <td>1.000</td> <td>PC</td> </tr> <tr> <td>RC1242A0</td> <td>D=10 CLOSED CAP</td> <td>2.000</td> <td>PC</td> </tr> <tr> <td>RC1356A0</td> <td>"STRAIGHT THREADED FEMALE END 8x1/4" BS</td> <td>1.000</td> <td>PC</td> </tr> <tr> <td>RC1414A1</td> <td>D11.5-12.5 SINGLE EAR HOSE CLAMP</td> <td>4.000</td> <td>PC</td> </tr> <tr> <td>TB2821A0</td> <td>EPDM 6X10 L=40MM PIPE</td> <td>6.000</td> <td>PC</td> </tr> <tr> <td>TB3004A0</td> <td>TB2820A L=550mm EPDM BLACK PIPE</td> <td>2.000</td> <td>PC</td> </tr> <tr> <td>TB3005B0</td> <td>TB3132A L=550mm EPDM WHITE-BLUE PIPE</td> <td>1.000</td> <td>PC</td> </tr> <tr> <td>TB3252A0</td> <td>TB3252A0</td> <td>1.000</td> <td>PC</td> </tr> <tr> <td>TB3469A0</td> <td></td> <td>1.000</td> <td>PC</td> </tr> <tr> <td>VI1220A1</td> <td>4,2x12 TCB SELF-TAPPIN G SCREW</td> <td>3.000</td> <td>PC</td> </tr> <tr> <td>VL1019A0</td> <td>VIBRATION DETERGENT PUMP</td> <td></td> <td>1.000</td> <td>PC</td> </tr> <tr> <td>VL1047A1</td> <td>D6 PIPE HOLDER - D8 J.G. TERMINAL</td> <td></td> <td>1.000</td> <td>PC</td> </tr> <tr> <td>VL1054B0</td> <td>ONE WASHING SYS INLET DISTRIBUTOR</td> <td></td> <td>1.000</td> <td>PC</td> </tr> </tbody> </table>	Code	Description	Qty	UOM	0H2428A2	XECC PLUS WASHING CIRCUIT PLAT	1.000	PC	EL1440A0	WATER SELF CLEANING VALVE	3.000	PC	GN1311A0	RUBBER CABLE-PASSI NG Dø=25 Di=12 Th=6,5	1.000	PC	GN1526A0	INT. D.=6.9 TH=1.8 O-RIN	7.000	PC	RC1018A0	ZINC PLATED D12 ELASTIC CLAMP	5.000	PC	RC1019A0	D=10 ELASTIC CLAMP	14.000	PC	RC1130A0	130x2,6 CLAM	1.000	PC	RC1131A0	200x2,6 BLACK CLAMP	1.000	PC	RC1242A0	D=10 CLOSED CAP	2.000	PC	RC1356A0	"STRAIGHT THREADED FEMALE END 8x1/4" BS	1.000	PC	RC1414A1	D11.5-12.5 SINGLE EAR HOSE CLAMP	4.000	PC	TB2821A0	EPDM 6X10 L=40MM PIPE	6.000	PC	TB3004A0	TB2820A L=550mm EPDM BLACK PIPE	2.000	PC	TB3005B0	TB3132A L=550mm EPDM WHITE-BLUE PIPE	1.000	PC	TB3252A0	TB3252A0	1.000	PC	TB3469A0		1.000	PC	VI1220A1	4,2x12 TCB SELF-TAPPIN G SCREW	3.000	PC	VL1019A0	VIBRATION DETERGENT PUMP		1.000	PC	VL1047A1	D6 PIPE HOLDER - D8 J.G. TERMINAL		1.000	PC	VL1054B0	ONE WASHING SYS INLET DISTRIBUTOR		1.000	PC
Code	Description	Qty	UOM																																																																																									
0H2428A2	XECC PLUS WASHING CIRCUIT PLAT	1.000	PC																																																																																									
EL1440A0	WATER SELF CLEANING VALVE	3.000	PC																																																																																									
GN1311A0	RUBBER CABLE-PASSI NG Dø=25 Di=12 Th=6,5	1.000	PC																																																																																									
GN1526A0	INT. D.=6.9 TH=1.8 O-RIN	7.000	PC																																																																																									
RC1018A0	ZINC PLATED D12 ELASTIC CLAMP	5.000	PC																																																																																									
RC1019A0	D=10 ELASTIC CLAMP	14.000	PC																																																																																									
RC1130A0	130x2,6 CLAM	1.000	PC																																																																																									
RC1131A0	200x2,6 BLACK CLAMP	1.000	PC																																																																																									
RC1242A0	D=10 CLOSED CAP	2.000	PC																																																																																									
RC1356A0	"STRAIGHT THREADED FEMALE END 8x1/4" BS	1.000	PC																																																																																									
RC1414A1	D11.5-12.5 SINGLE EAR HOSE CLAMP	4.000	PC																																																																																									
TB2821A0	EPDM 6X10 L=40MM PIPE	6.000	PC																																																																																									
TB3004A0	TB2820A L=550mm EPDM BLACK PIPE	2.000	PC																																																																																									
TB3005B0	TB3132A L=550mm EPDM WHITE-BLUE PIPE	1.000	PC																																																																																									
TB3252A0	TB3252A0	1.000	PC																																																																																									
TB3469A0		1.000	PC																																																																																									
VI1220A1	4,2x12 TCB SELF-TAPPIN G SCREW	3.000	PC																																																																																									
VL1019A0	VIBRATION DETERGENT PUMP		1.000	PC																																																																																								
VL1047A1	D6 PIPE HOLDER - D8 J.G. TERMINAL		1.000	PC																																																																																								
VL1054B0	ONE WASHING SYS INLET DISTRIBUTOR		1.000	PC																																																																																								



COMPONENT			SPARE PART																																															
Code	Description	Image	Code	Description	Kit components																																													
VL1019A	VIBRATION DETERGENT PUMP		KVL1212A	EUR COMPACT PLUS CLEANING SYSTEM KIT	<table border="1"> <thead> <tr> <th>Code</th> <th>Description</th> <th>Qty</th> <th>UOM</th> </tr> </thead> <tbody> <tr> <td>VL1065A1</td> <td>1/4 MALE N.O. PRESSURE SWITCH</td> <td>1.000</td> <td>PC</td> </tr> <tr> <td>VL1102A1</td> <td>DETERGENT LINE FILTER + BARBED VNR 6 MM</td> <td>1.000</td> <td>PC</td> </tr> <tr> <td>VL1127A1</td> <td>6mm BARBED T-SHAPED FITTING</td> <td>1.000</td> <td>PC</td> </tr> <tr> <td>VL1128A1</td> <td>D6 BARBED CHECK VALVE</td> <td>2.000</td> <td>PC</td> </tr> <tr> <td>VL1165A0</td> <td>BAM-BB6 STRAIGHT FITTING</td> <td>1.000</td> <td>PC</td> </tr> <tr> <td>VL1166A0</td> <td>BB6-AR6 L FITTING</td> <td>3.000</td> <td>PC</td> </tr> <tr> <td>VL1174C0</td> <td>D1.2 MM CALIBRATED NOZZLE</td> <td>1.000</td> <td>PC</td> </tr> <tr> <td>VL1185A0</td> <td>2 WAYS PLUS WASHING DISTRIBUTOR</td> <td>1.000</td> <td>PC</td> </tr> <tr> <td>VM2172A0</td> <td>LOCKING CLIP FOR PUMP WITH CIRCUIT</td> <td>3.000</td> <td>PC</td> </tr> </tbody> </table>	Code	Description	Qty	UOM	VL1065A1	1/4 MALE N.O. PRESSURE SWITCH	1.000	PC	VL1102A1	DETERGENT LINE FILTER + BARBED VNR 6 MM	1.000	PC	VL1127A1	6mm BARBED T-SHAPED FITTING	1.000	PC	VL1128A1	D6 BARBED CHECK VALVE	2.000	PC	VL1165A0	BAM-BB6 STRAIGHT FITTING	1.000	PC	VL1166A0	BB6-AR6 L FITTING	3.000	PC	VL1174C0	D1.2 MM CALIBRATED NOZZLE	1.000	PC	VL1185A0	2 WAYS PLUS WASHING DISTRIBUTOR	1.000	PC	VM2172A0	LOCKING CLIP FOR PUMP WITH CIRCUIT	3.000	PC					
			Code	Description	Qty	UOM																																												
VL1065A1	1/4 MALE N.O. PRESSURE SWITCH	1.000	PC																																															
VL1102A1	DETERGENT LINE FILTER + BARBED VNR 6 MM	1.000	PC																																															
VL1127A1	6mm BARBED T-SHAPED FITTING	1.000	PC																																															
VL1128A1	D6 BARBED CHECK VALVE	2.000	PC																																															
VL1165A0	BAM-BB6 STRAIGHT FITTING	1.000	PC																																															
VL1166A0	BB6-AR6 L FITTING	3.000	PC																																															
VL1174C0	D1.2 MM CALIBRATED NOZZLE	1.000	PC																																															
VL1185A0	2 WAYS PLUS WASHING DISTRIBUTOR	1.000	PC																																															
VM2172A0	LOCKING CLIP FOR PUMP WITH CIRCUIT	3.000	PC																																															
KVL1211A	ONE COMPACT AND 0523-EP WASH. SYSTEM KIT	<table border="1"> <thead> <tr> <th>Code</th> <th>Description</th> <th>Qty</th> <th>UOM</th> </tr> </thead> <tbody> <tr> <td>0H2427A0</td> <td>XECC WASHING CIRCUIT HOLDING PLATE</td> <td>1.000</td> <td>PC</td> </tr> <tr> <td>EL1440A0</td> <td>WATER SELF CLEANING VALVE</td> <td>1.000</td> <td>PC</td> </tr> <tr> <td>GN1526A0</td> <td>INT. D.=6.9 TH=1.8 O-RIN</td> <td>3.000</td> <td>PC</td> </tr> <tr> <td>RC1018A0</td> <td>ZINC PLATED D12 ELASTIC CLAMP</td> <td>4.000</td> <td>PC</td> </tr> <tr> <td>RC1019A0</td> <td>D=10 ELASTIC CLAMP</td> <td>14.000</td> <td>PC</td> </tr> <tr> <td>RC1130A0</td> <td>130x2.6 CLAM</td> <td>1.000</td> <td>PC</td> </tr> <tr> <td>RC1242A0</td> <td>D=10 CLOSED CAP</td> <td>2.000</td> <td>PC</td> </tr> <tr> <td>RC1414A1</td> <td>D11.5-12.5 SINGLE EAR HOSE CLAMP</td> <td>4.000</td> <td>PC</td> </tr> <tr> <td>TB2821A0</td> <td>EPDM 6X10 L=40MM PIPE</td> <td>6.000</td> <td>PC</td> </tr> <tr> <td>TB3004A0</td> <td>TB2820A L=550mm EPDM BLACK PIPE</td> <td>1.000</td> <td>PC</td> </tr> <tr> <td>TB3252A0</td> <td>TB3252A0</td> <td>1.000</td> <td>PC</td> </tr> </tbody> </table>	Code	Description	Qty	UOM	0H2427A0	XECC WASHING CIRCUIT HOLDING PLATE	1.000	PC	EL1440A0	WATER SELF CLEANING VALVE	1.000	PC	GN1526A0	INT. D.=6.9 TH=1.8 O-RIN	3.000	PC	RC1018A0	ZINC PLATED D12 ELASTIC CLAMP	4.000	PC	RC1019A0	D=10 ELASTIC CLAMP	14.000	PC	RC1130A0	130x2.6 CLAM	1.000	PC	RC1242A0	D=10 CLOSED CAP	2.000	PC	RC1414A1	D11.5-12.5 SINGLE EAR HOSE CLAMP	4.000	PC	TB2821A0	EPDM 6X10 L=40MM PIPE	6.000	PC	TB3004A0	TB2820A L=550mm EPDM BLACK PIPE	1.000	PC	TB3252A0	TB3252A0	1.000	PC
Code	Description	Qty	UOM																																															
0H2427A0	XECC WASHING CIRCUIT HOLDING PLATE	1.000	PC																																															
EL1440A0	WATER SELF CLEANING VALVE	1.000	PC																																															
GN1526A0	INT. D.=6.9 TH=1.8 O-RIN	3.000	PC																																															
RC1018A0	ZINC PLATED D12 ELASTIC CLAMP	4.000	PC																																															
RC1019A0	D=10 ELASTIC CLAMP	14.000	PC																																															
RC1130A0	130x2.6 CLAM	1.000	PC																																															
RC1242A0	D=10 CLOSED CAP	2.000	PC																																															
RC1414A1	D11.5-12.5 SINGLE EAR HOSE CLAMP	4.000	PC																																															
TB2821A0	EPDM 6X10 L=40MM PIPE	6.000	PC																																															
TB3004A0	TB2820A L=550mm EPDM BLACK PIPE	1.000	PC																																															
TB3252A0	TB3252A0	1.000	PC																																															



COMPONENT			SPARE PART																																																																																					
Code	Description	Image	Code	Description	Kit components																																																																																			
VL1019A	VIBRATION DETERGENT PUMP		KVL1211A	ONE COMPACT AND 0523-EP WASH. SYSTEM KIT	<table border="1"> <thead> <tr> <th>Code</th> <th>Description</th> <th>Qty</th> <th>UOM</th> </tr> </thead> <tbody> <tr> <td>TB3469A0</td> <td></td> <td>1.000</td> <td>PC</td> </tr> <tr> <td>V11220A1</td> <td>4.2x12 TCB SELF-TAPPIN G SCREW</td> <td>4.000</td> <td>PC</td> </tr> <tr> <td>VL1019A0</td> <td>VIBRATION DETERGENT PUMP</td> <td>1.000</td> <td>PC</td> </tr> <tr> <td>VL1047A1</td> <td>D6 PIPE HOLDER - D8 J.G. TERMINAL</td> <td>1.000</td> <td>PC</td> </tr> <tr> <td>VL1054B0</td> <td>ONE WASHING SYS INLET DISTRIBUTOR</td> <td>1.000</td> <td>PC</td> </tr> <tr> <td>VL1102A1</td> <td>DETERGENT LINE FILTER + BARBED VNR 6 MM</td> <td>1.000</td> <td>PC</td> </tr> <tr> <td>VL1127A1</td> <td>6mm BARBED T-SHAPED FITTING</td> <td>1.000</td> <td>PC</td> </tr> <tr> <td>VL1128A1</td> <td>D6 BARBED CHECK VALVE</td> <td>2.000</td> <td>PC</td> </tr> <tr> <td>VL1165A0</td> <td>BAM-BB6 STRAIGHT FITTING</td> <td>1.000</td> <td>PC</td> </tr> <tr> <td>VL1166A0</td> <td>BB6-AR6 L FITTING</td> <td>1.000</td> <td>PC</td> </tr> <tr> <td>VL1174C0</td> <td>D1.2 MM CALIBRATED NOZZLE</td> <td>1.000</td> <td>PC</td> </tr> <tr> <td>VL1191A0</td> <td>ONE WASHING DISTRIBUTOR OUTLETS KIT</td> <td>1.000</td> <td>PC</td> </tr> <tr> <td>VM2172A0</td> <td>LOCKING CLIP FOR PUMP WITH CIRCUIT</td> <td>2.000</td> <td>PC</td> </tr> </tbody> </table>	Code	Description	Qty	UOM	TB3469A0		1.000	PC	V11220A1	4.2x12 TCB SELF-TAPPIN G SCREW	4.000	PC	VL1019A0	VIBRATION DETERGENT PUMP	1.000	PC	VL1047A1	D6 PIPE HOLDER - D8 J.G. TERMINAL	1.000	PC	VL1054B0	ONE WASHING SYS INLET DISTRIBUTOR	1.000	PC	VL1102A1	DETERGENT LINE FILTER + BARBED VNR 6 MM	1.000	PC	VL1127A1	6mm BARBED T-SHAPED FITTING	1.000	PC	VL1128A1	D6 BARBED CHECK VALVE	2.000	PC	VL1165A0	BAM-BB6 STRAIGHT FITTING	1.000	PC	VL1166A0	BB6-AR6 L FITTING	1.000	PC	VL1174C0	D1.2 MM CALIBRATED NOZZLE	1.000	PC	VL1191A0	ONE WASHING DISTRIBUTOR OUTLETS KIT	1.000	PC	VM2172A0	LOCKING CLIP FOR PUMP WITH CIRCUIT	2.000	PC	KVL1209A	US PLUS 3 ROTOR ARMS WASHING SYSTEM KIT	<table border="1"> <thead> <tr> <th>Code</th> <th>Description</th> <th>Qty</th> <th>UOM</th> </tr> </thead> <tbody> <tr> <td>0H2354A1</td> <td>XEVC-XEVL PLUS WASHING CIRCUIT PLAT</td> <td>1.000</td> <td>PC</td> </tr> <tr> <td>EL1450A0</td> <td>US SELF-CLEANIN G WATER SOLENOID</td> <td>4.000</td> <td>PC</td> </tr> <tr> <td>GN1526A0</td> <td>INT. D.=6.9 TH=1.8 O-RIN</td> <td>9.000</td> <td>PC</td> </tr> <tr> <td>RC1018A0</td> <td>ZINC PLATED D12 ELASTIC CLAMP</td> <td>11.000</td> <td>PC</td> </tr> <tr> <td>RC1019A0</td> <td>D=10 ELASTIC CLAMP</td> <td>14.000</td> <td>PC</td> </tr> </tbody> </table>	Code	Description	Qty	UOM	0H2354A1	XEVC-XEVL PLUS WASHING CIRCUIT PLAT	1.000	PC	EL1450A0	US SELF-CLEANIN G WATER SOLENOID	4.000	PC	GN1526A0	INT. D.=6.9 TH=1.8 O-RIN	9.000	PC	RC1018A0	ZINC PLATED D12 ELASTIC CLAMP	11.000	PC	RC1019A0	D=10 ELASTIC CLAMP	14.000	PC
			Code	Description	Qty	UOM																																																																																		
TB3469A0		1.000	PC																																																																																					
V11220A1	4.2x12 TCB SELF-TAPPIN G SCREW	4.000	PC																																																																																					
VL1019A0	VIBRATION DETERGENT PUMP	1.000	PC																																																																																					
VL1047A1	D6 PIPE HOLDER - D8 J.G. TERMINAL	1.000	PC																																																																																					
VL1054B0	ONE WASHING SYS INLET DISTRIBUTOR	1.000	PC																																																																																					
VL1102A1	DETERGENT LINE FILTER + BARBED VNR 6 MM	1.000	PC																																																																																					
VL1127A1	6mm BARBED T-SHAPED FITTING	1.000	PC																																																																																					
VL1128A1	D6 BARBED CHECK VALVE	2.000	PC																																																																																					
VL1165A0	BAM-BB6 STRAIGHT FITTING	1.000	PC																																																																																					
VL1166A0	BB6-AR6 L FITTING	1.000	PC																																																																																					
VL1174C0	D1.2 MM CALIBRATED NOZZLE	1.000	PC																																																																																					
VL1191A0	ONE WASHING DISTRIBUTOR OUTLETS KIT	1.000	PC																																																																																					
VM2172A0	LOCKING CLIP FOR PUMP WITH CIRCUIT	2.000	PC																																																																																					
Code	Description	Qty	UOM																																																																																					
0H2354A1	XEVC-XEVL PLUS WASHING CIRCUIT PLAT	1.000	PC																																																																																					
EL1450A0	US SELF-CLEANIN G WATER SOLENOID	4.000	PC																																																																																					
GN1526A0	INT. D.=6.9 TH=1.8 O-RIN	9.000	PC																																																																																					
RC1018A0	ZINC PLATED D12 ELASTIC CLAMP	11.000	PC																																																																																					
RC1019A0	D=10 ELASTIC CLAMP	14.000	PC																																																																																					



COMPONENT			SPARE PART																																																																																																						
Code	Description	Image	Code	Description	Kit components																																																																																																				
VL1019A	VIBRATION DETERGENT PUMP		KVL1209A	US PLUS 3 ROTOR ARMS WASHING SYSTEM KIT	<table border="1"> <thead> <tr> <th>Code</th> <th>Description</th> <th>Qty</th> <th>UOM</th> </tr> </thead> <tbody> <tr> <td>RC1130A0</td> <td>130x2,6 CLAM</td> <td>1.000</td> <td>PC</td> </tr> <tr> <td>RC1131A0</td> <td>200x2,6 BLACK CLAMP</td> <td>3.000</td> <td>PC</td> </tr> <tr> <td>RC1242A0</td> <td>D=10 CLOSED CAP</td> <td>2.000</td> <td>PC</td> </tr> <tr> <td>RC1356A0</td> <td>"STRAIGHT THREADED FEMALE END 8x1/4" BS</td> <td>1.000</td> <td>PC</td> </tr> <tr> <td>RC1414A1</td> <td>D11.5-12.5 SINGLE EAR HOSE CLAMP</td> <td>1.000</td> <td>PC</td> </tr> <tr> <td>TB2652A0</td> <td></td> <td>1.000</td> <td>PC</td> </tr> <tr> <td>TB2677A0</td> <td></td> <td>1.000</td> <td>PC</td> </tr> <tr> <td>TB2821A0</td> <td>EPDM 6X10 L=40MM PIPE</td> <td>4.000</td> <td>PC</td> </tr> <tr> <td>TB3004A0</td> <td>TB2820A L=550mm EPDM BLACK PIPE</td> <td>2.000</td> <td>PC</td> </tr> <tr> <td>TB3024C0</td> <td></td> <td>3.000</td> <td>PC</td> </tr> <tr> <td>TB3226A0</td> <td></td> <td>1.000</td> <td>PC</td> </tr> <tr> <td>TB3440A0</td> <td>TB3132A L=1050mm EPDM WHITE-BLUE PIPE</td> <td>1.000</td> <td>PC</td> </tr> <tr> <td>TB3614A0</td> <td>TB3614A0</td> <td>1.000</td> <td>PC</td> </tr> <tr> <td>VH1220A1</td> <td>4,2x12 TCB SELF-TAPPIN G SCREW</td> <td>1.000</td> <td>PC</td> </tr> <tr> <td>VL1019A0</td> <td>VIBRATION DETERGENT PUMP</td> <td></td> <td>1.000</td> <td>PC</td> </tr> <tr> <td>VL1065A1</td> <td>1/4 MALE N.O. PRESSURE SWITCH</td> <td></td> <td>1.000</td> <td>PC</td> </tr> <tr> <td>VL1102A1</td> <td>DETERGENT LINE FILTER + BARBED VNR 6 MM</td> <td></td> <td>1.000</td> <td>PC</td> </tr> <tr> <td>VL1127A1</td> <td>6mm BARBED T-SHAPED FITTING</td> <td></td> <td>2.000</td> <td>PC</td> </tr> <tr> <td>VL1128A1</td> <td>D6 BARBED CHECK VALVE</td> <td></td> <td>2.000</td> <td>PC</td> </tr> <tr> <td>VL1166A0</td> <td>BB6-AR6 L FITTING</td> <td></td> <td>4.000</td> <td>PC</td> </tr> <tr> <td>VL1167A2</td> <td>GN21 3 ROTOR ARMS B-B FLOW RESTRICTOR</td> <td></td> <td>1.000</td> <td>PC</td> </tr> <tr> <td>VL1174C0</td> <td>D1.2 MM CALIBRATED NOZZLE</td> <td></td> <td>1.000</td> <td>PC</td> </tr> </tbody> </table>	Code	Description	Qty	UOM	RC1130A0	130x2,6 CLAM	1.000	PC	RC1131A0	200x2,6 BLACK CLAMP	3.000	PC	RC1242A0	D=10 CLOSED CAP	2.000	PC	RC1356A0	"STRAIGHT THREADED FEMALE END 8x1/4" BS	1.000	PC	RC1414A1	D11.5-12.5 SINGLE EAR HOSE CLAMP	1.000	PC	TB2652A0		1.000	PC	TB2677A0		1.000	PC	TB2821A0	EPDM 6X10 L=40MM PIPE	4.000	PC	TB3004A0	TB2820A L=550mm EPDM BLACK PIPE	2.000	PC	TB3024C0		3.000	PC	TB3226A0		1.000	PC	TB3440A0	TB3132A L=1050mm EPDM WHITE-BLUE PIPE	1.000	PC	TB3614A0	TB3614A0	1.000	PC	VH1220A1	4,2x12 TCB SELF-TAPPIN G SCREW	1.000	PC	VL1019A0	VIBRATION DETERGENT PUMP		1.000	PC	VL1065A1	1/4 MALE N.O. PRESSURE SWITCH		1.000	PC	VL1102A1	DETERGENT LINE FILTER + BARBED VNR 6 MM		1.000	PC	VL1127A1	6mm BARBED T-SHAPED FITTING		2.000	PC	VL1128A1	D6 BARBED CHECK VALVE		2.000	PC	VL1166A0	BB6-AR6 L FITTING		4.000	PC	VL1167A2	GN21 3 ROTOR ARMS B-B FLOW RESTRICTOR		1.000	PC	VL1174C0	D1.2 MM CALIBRATED NOZZLE		1.000	PC
Code	Description	Qty	UOM																																																																																																						
RC1130A0	130x2,6 CLAM	1.000	PC																																																																																																						
RC1131A0	200x2,6 BLACK CLAMP	3.000	PC																																																																																																						
RC1242A0	D=10 CLOSED CAP	2.000	PC																																																																																																						
RC1356A0	"STRAIGHT THREADED FEMALE END 8x1/4" BS	1.000	PC																																																																																																						
RC1414A1	D11.5-12.5 SINGLE EAR HOSE CLAMP	1.000	PC																																																																																																						
TB2652A0		1.000	PC																																																																																																						
TB2677A0		1.000	PC																																																																																																						
TB2821A0	EPDM 6X10 L=40MM PIPE	4.000	PC																																																																																																						
TB3004A0	TB2820A L=550mm EPDM BLACK PIPE	2.000	PC																																																																																																						
TB3024C0		3.000	PC																																																																																																						
TB3226A0		1.000	PC																																																																																																						
TB3440A0	TB3132A L=1050mm EPDM WHITE-BLUE PIPE	1.000	PC																																																																																																						
TB3614A0	TB3614A0	1.000	PC																																																																																																						
VH1220A1	4,2x12 TCB SELF-TAPPIN G SCREW	1.000	PC																																																																																																						
VL1019A0	VIBRATION DETERGENT PUMP		1.000	PC																																																																																																					
VL1065A1	1/4 MALE N.O. PRESSURE SWITCH		1.000	PC																																																																																																					
VL1102A1	DETERGENT LINE FILTER + BARBED VNR 6 MM		1.000	PC																																																																																																					
VL1127A1	6mm BARBED T-SHAPED FITTING		2.000	PC																																																																																																					
VL1128A1	D6 BARBED CHECK VALVE		2.000	PC																																																																																																					
VL1166A0	BB6-AR6 L FITTING		4.000	PC																																																																																																					
VL1167A2	GN21 3 ROTOR ARMS B-B FLOW RESTRICTOR		1.000	PC																																																																																																					
VL1174C0	D1.2 MM CALIBRATED NOZZLE		1.000	PC																																																																																																					



COMPONENT			SPARE PART																																																							
Code	Description	Image	Code	Description	Kit components																																																					
VL1019A	VIBRATION DETERGENT PUMP		KVL1209A	US PLUS 3 ROTOR ARMS WASHING SYSTEM KIT	<table border="1"> <thead> <tr> <th>Code</th> <th>Description</th> <th>Qty</th> <th>UOM</th> </tr> </thead> <tbody> <tr> <td>VL1186A0</td> <td>3 WAYS PLUS WASHING DISTRIBUTOR</td> <td>1.000</td> <td>PC</td> </tr> <tr> <td>VL1190A0</td> <td>PLUS WASHING SYSTEM INLET DISTRIBUTOR</td> <td>1.000</td> <td>PC</td> </tr> <tr> <td>VL1214A0</td> <td>BAYONET - 6mm BARBED NRV VALVE</td> <td>1.000</td> <td>PC</td> </tr> <tr> <td>VM1605A0</td> <td>CLIP TWIST LOCK DIAM. 10,2-12,7 MM</td> <td>3.000</td> <td>PC</td> </tr> <tr> <td>VM2172A0</td> <td>LOCKING CLIP FOR PUMP WITH CIRCUIT</td> <td>5.000</td> <td>PC</td> </tr> </tbody> </table>	Code	Description	Qty	UOM	VL1186A0	3 WAYS PLUS WASHING DISTRIBUTOR	1.000	PC	VL1190A0	PLUS WASHING SYSTEM INLET DISTRIBUTOR	1.000	PC	VL1214A0	BAYONET - 6mm BARBED NRV VALVE	1.000	PC	VM1605A0	CLIP TWIST LOCK DIAM. 10,2-12,7 MM	3.000	PC	VM2172A0	LOCKING CLIP FOR PUMP WITH CIRCUIT	5.000	PC																													
			Code	Description	Qty	UOM																																																				
VL1186A0	3 WAYS PLUS WASHING DISTRIBUTOR	1.000	PC																																																							
VL1190A0	PLUS WASHING SYSTEM INLET DISTRIBUTOR	1.000	PC																																																							
VL1214A0	BAYONET - 6mm BARBED NRV VALVE	1.000	PC																																																							
VM1605A0	CLIP TWIST LOCK DIAM. 10,2-12,7 MM	3.000	PC																																																							
VM2172A0	LOCKING CLIP FOR PUMP WITH CIRCUIT	5.000	PC																																																							
KVL1208A	US PLUS 2 ROTOR ARMS WASHING SYSTEM KIT	<table border="1"> <thead> <tr> <th>Code</th> <th>Description</th> <th>Qty</th> <th>UOM</th> </tr> </thead> <tbody> <tr> <td>0H2354A1</td> <td>XEVC-XEVL PLUS WASHING CIRCUIT PLAT</td> <td>1.000</td> <td>PC</td> </tr> <tr> <td>EL1450A0</td> <td>US SELF-CLEANIN G WATER SOLENOID</td> <td>4.000</td> <td>PC</td> </tr> <tr> <td>GN1526A0</td> <td>INT. D.=6.9 TH=1.8 O-RIN</td> <td>9.000</td> <td>PC</td> </tr> <tr> <td>RC1018A0</td> <td>ZINC PLATED D12 ELASTIC CLAMP</td> <td>3.000</td> <td>PC</td> </tr> <tr> <td>RC1019A0</td> <td>D=10 ELASTIC CLAMP</td> <td>2.000</td> <td>PC</td> </tr> <tr> <td>RC1130A0</td> <td>130x2,6 CLAM</td> <td>1.000</td> <td>PC</td> </tr> <tr> <td>RC1131A0</td> <td>200x2,6 BLACK CLAMP</td> <td>3.000</td> <td>PC</td> </tr> <tr> <td>RC1242A0</td> <td>D=10 CLOSED CAP</td> <td>2.000</td> <td>PC</td> </tr> <tr> <td>RC1356A0</td> <td>"STRAIGHT THREADED FEMALE END 8x1/4" BS</td> <td>1.000</td> <td>PC</td> </tr> <tr> <td>RC1414A1</td> <td>D11.5-12.5 SINGLE EAR HOSE CLAMP</td> <td>4.000</td> <td>PC</td> </tr> <tr> <td>TB2821A0</td> <td>EPDM 6X10 L=40MM PIPE</td> <td>6.000</td> <td>PC</td> </tr> <tr> <td>TB2994A0</td> <td>HOOD DETERGENT PIPE</td> <td>1.000</td> <td>PC</td> </tr> <tr> <td>TB3004A0</td> <td>TB2820A L=550mm EPDM BLACK PIPE</td> <td>1.000</td> <td>PC</td> </tr> </tbody> </table>	Code	Description	Qty	UOM	0H2354A1	XEVC-XEVL PLUS WASHING CIRCUIT PLAT	1.000	PC	EL1450A0	US SELF-CLEANIN G WATER SOLENOID	4.000	PC	GN1526A0	INT. D.=6.9 TH=1.8 O-RIN	9.000	PC	RC1018A0	ZINC PLATED D12 ELASTIC CLAMP	3.000	PC	RC1019A0	D=10 ELASTIC CLAMP	2.000	PC	RC1130A0	130x2,6 CLAM	1.000	PC	RC1131A0	200x2,6 BLACK CLAMP	3.000	PC	RC1242A0	D=10 CLOSED CAP	2.000	PC	RC1356A0	"STRAIGHT THREADED FEMALE END 8x1/4" BS	1.000	PC	RC1414A1	D11.5-12.5 SINGLE EAR HOSE CLAMP	4.000	PC	TB2821A0	EPDM 6X10 L=40MM PIPE	6.000	PC	TB2994A0	HOOD DETERGENT PIPE	1.000	PC	TB3004A0	TB2820A L=550mm EPDM BLACK PIPE	1.000	PC
Code	Description	Qty	UOM																																																							
0H2354A1	XEVC-XEVL PLUS WASHING CIRCUIT PLAT	1.000	PC																																																							
EL1450A0	US SELF-CLEANIN G WATER SOLENOID	4.000	PC																																																							
GN1526A0	INT. D.=6.9 TH=1.8 O-RIN	9.000	PC																																																							
RC1018A0	ZINC PLATED D12 ELASTIC CLAMP	3.000	PC																																																							
RC1019A0	D=10 ELASTIC CLAMP	2.000	PC																																																							
RC1130A0	130x2,6 CLAM	1.000	PC																																																							
RC1131A0	200x2,6 BLACK CLAMP	3.000	PC																																																							
RC1242A0	D=10 CLOSED CAP	2.000	PC																																																							
RC1356A0	"STRAIGHT THREADED FEMALE END 8x1/4" BS	1.000	PC																																																							
RC1414A1	D11.5-12.5 SINGLE EAR HOSE CLAMP	4.000	PC																																																							
TB2821A0	EPDM 6X10 L=40MM PIPE	6.000	PC																																																							
TB2994A0	HOOD DETERGENT PIPE	1.000	PC																																																							
TB3004A0	TB2820A L=550mm EPDM BLACK PIPE	1.000	PC																																																							





COMPONENT			SPARE PART					
Code	Description	Image	Code	Description	Kit components			
VL1019A	VIBRATION DETERGENT PUMP		KVL1208A	US PLUS 2 ROTOR ARMS WASHING SYSTEM KIT	Code	Description	Qty	UOM
					TB3005B0	TB3132A L=550mm EPDM WHITE-BLUE PIPE	1.000	PC
					TB3440A0	TB3132A L=1050mm EPDM WHITE-BLUE PIPE	1.000	PC
					VL1019A0	VIBRATION DETERGENT PUMP	1.000	PC
					VL1047A1	D6 PIPE HOLDER - D8 J.G. TERMINAL	1.000	PC
					VL1065A1	1/4 MALE N.O. PRESSURE SWITCH	1.000	PC
					VL1102A1	DETERGENT LINE FILTER + BARBED VNR 6 MM	1.000	PC
					VL1128A1	D6 BARBED CHECK VALVE	2.000	PC
					VL1141A1	BB6-BB6 STRAIGHT CONNECTION	1.000	PC
					VL1166A0	BB6-AR6 L FITTING	4.000	PC
					VL1174C0	D1.2 MM CALIBRATED NOZZLE	1.000	PC
					VL1186A0	3 WAYS PLUS WASHING DISTRIBUTOR	1.000	PC
					VL1190A0	PLUS WASHING SYSTEM INLET DISTRIBUTOR	1.000	PC
					VL1214A0	BAYONET - 6mm BARBED NRV VALVE	1.000	PC
					VM1605A0	CLIP TWIST LOCK DIAM. 10,2-12,7 MM	3.000	PC
					VM2172A0	LOCKING CLIP FOR PUMP WITH CIRCUIT	5.000	PC



COMPONENT			SPARE PART																																																																																								
Code	Description	Image	Code	Description	Kit components																																																																																						
VL1019A	VIBRATION DETERGENT PUMP		KVL1207A	US PLUS 1 ROTOR ARM WASHING SYSTEM KIT	<table border="1"> <thead> <tr> <th>Code</th> <th>Description</th> <th>Qty</th> <th>UOM</th> </tr> </thead> <tbody> <tr> <td>0H2354A1</td> <td>XEVC-XEVL PLUS WASHING CIRCUIT PLAT</td> <td>1.000</td> <td>PC</td> </tr> <tr> <td>EL1450A0</td> <td>US SELF-CLEANIN G WATER SOLENOID</td> <td>3.000</td> <td>PC</td> </tr> <tr> <td>GN1526A0</td> <td>INT. D.=6.9 TH=1.8 O-RIN</td> <td>7.000</td> <td>PC</td> </tr> <tr> <td>RC1018A0</td> <td>ZINC PLATED D12 ELASTIC CLAMP</td> <td>1.000</td> <td>PC</td> </tr> <tr> <td>RC1019A0</td> <td>D=10 ELASTIC CLAMP</td> <td>12.000</td> <td>PC</td> </tr> <tr> <td>RC1130A0</td> <td>130x2,6 CLAM</td> <td>1.000</td> <td>PC</td> </tr> <tr> <td>RC1131A0</td> <td>200x2,6 BLACK CLAMP</td> <td>2.000</td> <td>PC</td> </tr> <tr> <td>RC1242A0</td> <td>D=10 CLOSED CAP</td> <td>2.000</td> <td>PC</td> </tr> <tr> <td>RC1356A0</td> <td>*STRAIGHT THREADED FEMALE END 8x1/4" BS</td> <td>1.000</td> <td>PC</td> </tr> <tr> <td>RC1414A1</td> <td>D11.5-12.5 SINGLE EAR HOSE CLAMP</td> <td>5.000</td> <td>PC</td> </tr> <tr> <td>TB2821A0</td> <td>EPDM 6X10 L=40MM PIPE</td> <td>4.000</td> <td>PC</td> </tr> <tr> <td>TB3004A0</td> <td>TB2820A L=550mm EPDM BLACK PIPE</td> <td>1.000</td> <td>PC</td> </tr> <tr> <td>TB3005B0</td> <td>TB3132A L=550mm EPDM WHITE-BLUE PIPE</td> <td>2.000</td> <td>PC</td> </tr> <tr> <td>TB3024C0</td> <td></td> <td>1.000</td> <td>PC</td> </tr> <tr> <td>TB3225B0</td> <td>TB2820A-TAN K-WASHYNG SYS CONNECTION</td> <td>1.000</td> <td>PC</td> </tr> <tr> <td>TB3252A0</td> <td>TB3252A0</td> <td>1.000</td> <td>PC</td> </tr> <tr> <td>TB3614A0</td> <td>TB3614A0</td> <td>1.000</td> <td>PC</td> </tr> <tr> <td>VI1220A1</td> <td>4,2x12 TCB SELF-TAPPIN G SCREW</td> <td>1.000</td> <td>PC</td> </tr> <tr> <td>VL1019A0</td> <td>VIBRATION DETERGENT PUMP</td> <td></td> <td>1.000</td> <td>PC</td> </tr> <tr> <td>VL1047A1</td> <td>D6 PIPE HOLDER - D8 J.G. TERMINAL</td> <td></td> <td>1.000</td> <td>PC</td> </tr> </tbody> </table>	Code	Description	Qty	UOM	0H2354A1	XEVC-XEVL PLUS WASHING CIRCUIT PLAT	1.000	PC	EL1450A0	US SELF-CLEANIN G WATER SOLENOID	3.000	PC	GN1526A0	INT. D.=6.9 TH=1.8 O-RIN	7.000	PC	RC1018A0	ZINC PLATED D12 ELASTIC CLAMP	1.000	PC	RC1019A0	D=10 ELASTIC CLAMP	12.000	PC	RC1130A0	130x2,6 CLAM	1.000	PC	RC1131A0	200x2,6 BLACK CLAMP	2.000	PC	RC1242A0	D=10 CLOSED CAP	2.000	PC	RC1356A0	*STRAIGHT THREADED FEMALE END 8x1/4" BS	1.000	PC	RC1414A1	D11.5-12.5 SINGLE EAR HOSE CLAMP	5.000	PC	TB2821A0	EPDM 6X10 L=40MM PIPE	4.000	PC	TB3004A0	TB2820A L=550mm EPDM BLACK PIPE	1.000	PC	TB3005B0	TB3132A L=550mm EPDM WHITE-BLUE PIPE	2.000	PC	TB3024C0		1.000	PC	TB3225B0	TB2820A-TAN K-WASHYNG SYS CONNECTION	1.000	PC	TB3252A0	TB3252A0	1.000	PC	TB3614A0	TB3614A0	1.000	PC	VI1220A1	4,2x12 TCB SELF-TAPPIN G SCREW	1.000	PC	VL1019A0	VIBRATION DETERGENT PUMP		1.000	PC	VL1047A1	D6 PIPE HOLDER - D8 J.G. TERMINAL		1.000	PC
Code	Description	Qty	UOM																																																																																								
0H2354A1	XEVC-XEVL PLUS WASHING CIRCUIT PLAT	1.000	PC																																																																																								
EL1450A0	US SELF-CLEANIN G WATER SOLENOID	3.000	PC																																																																																								
GN1526A0	INT. D.=6.9 TH=1.8 O-RIN	7.000	PC																																																																																								
RC1018A0	ZINC PLATED D12 ELASTIC CLAMP	1.000	PC																																																																																								
RC1019A0	D=10 ELASTIC CLAMP	12.000	PC																																																																																								
RC1130A0	130x2,6 CLAM	1.000	PC																																																																																								
RC1131A0	200x2,6 BLACK CLAMP	2.000	PC																																																																																								
RC1242A0	D=10 CLOSED CAP	2.000	PC																																																																																								
RC1356A0	*STRAIGHT THREADED FEMALE END 8x1/4" BS	1.000	PC																																																																																								
RC1414A1	D11.5-12.5 SINGLE EAR HOSE CLAMP	5.000	PC																																																																																								
TB2821A0	EPDM 6X10 L=40MM PIPE	4.000	PC																																																																																								
TB3004A0	TB2820A L=550mm EPDM BLACK PIPE	1.000	PC																																																																																								
TB3005B0	TB3132A L=550mm EPDM WHITE-BLUE PIPE	2.000	PC																																																																																								
TB3024C0		1.000	PC																																																																																								
TB3225B0	TB2820A-TAN K-WASHYNG SYS CONNECTION	1.000	PC																																																																																								
TB3252A0	TB3252A0	1.000	PC																																																																																								
TB3614A0	TB3614A0	1.000	PC																																																																																								
VI1220A1	4,2x12 TCB SELF-TAPPIN G SCREW	1.000	PC																																																																																								
VL1019A0	VIBRATION DETERGENT PUMP		1.000	PC																																																																																							
VL1047A1	D6 PIPE HOLDER - D8 J.G. TERMINAL		1.000	PC																																																																																							



COMPONENT			SPARE PART																																																																																									
Code	Description	Image	Code	Description	Kit components																																																																																							
VL1019A	VIBRATION DETERGENT PUMP		KVL1207A	US PLUS 1 ROTOR ARM WASHING SYSTEM KIT	<table border="1"> <thead> <tr> <th>Code</th> <th>Description</th> <th>Qty</th> <th>UOM</th> </tr> </thead> <tbody> <tr> <td>VL1102A1</td> <td>DETERGENT LINE FILTER + BARBED VNR 6 MM</td> <td>1.000</td> <td>PC</td> </tr> <tr> <td>VL1127A1</td> <td>6mm BARBED T-SHAPED FITTING</td> <td>1.000</td> <td>PC</td> </tr> <tr> <td>VL1128A1</td> <td>D6 BARBED CHECK VALVE</td> <td>1.000</td> <td>PC</td> </tr> <tr> <td>VL1166A0</td> <td>BB6-AR6 L FITTING</td> <td>3.000</td> <td>PC</td> </tr> <tr> <td>VL1174C0</td> <td>D1.2 MM CALIBRATED NOZZLE</td> <td>1.000</td> <td>PC</td> </tr> <tr> <td>VL1185A0</td> <td>2 WAYS PLUS WASHING DISTRIBUTOR</td> <td>1.000</td> <td>PC</td> </tr> <tr> <td>VL1190A0</td> <td>PLUS WASHING SYSTEM INLET DISTRIBUTOR</td> <td>1.000</td> <td>PC</td> </tr> <tr> <td>VL1214A0</td> <td>BAYONET - 6mm BARBED NRV VALVE</td> <td>1.000</td> <td>PC</td> </tr> <tr> <td>VL1398A0</td> <td>1/4 M N.O. CIL PRESSURE SWITCH</td> <td>1.000</td> <td>PC</td> </tr> <tr> <td>VM1605A0</td> <td>CLIP TWIST LOCK DIAM. 10.2-12.7 MM</td> <td>3.000</td> <td>PC</td> </tr> <tr> <td>VM2172A0</td> <td>LOCKING CLIP FOR PUMP WITH CIRCUIT</td> <td>4.000</td> <td>PC</td> </tr> </tbody> </table>	Code	Description	Qty	UOM	VL1102A1	DETERGENT LINE FILTER + BARBED VNR 6 MM	1.000	PC	VL1127A1	6mm BARBED T-SHAPED FITTING	1.000	PC	VL1128A1	D6 BARBED CHECK VALVE	1.000	PC	VL1166A0	BB6-AR6 L FITTING	3.000	PC	VL1174C0	D1.2 MM CALIBRATED NOZZLE	1.000	PC	VL1185A0	2 WAYS PLUS WASHING DISTRIBUTOR	1.000	PC	VL1190A0	PLUS WASHING SYSTEM INLET DISTRIBUTOR	1.000	PC	VL1214A0	BAYONET - 6mm BARBED NRV VALVE	1.000	PC	VL1398A0	1/4 M N.O. CIL PRESSURE SWITCH	1.000	PC	VM1605A0	CLIP TWIST LOCK DIAM. 10.2-12.7 MM	3.000	PC	VM2172A0	LOCKING CLIP FOR PUMP WITH CIRCUIT	4.000	PC	KVL1198A	MM EU HOOD CLEANING SYSTEM KIT	<table border="1"> <thead> <tr> <th>Code</th> <th>Description</th> <th>Qty</th> <th>UOM</th> </tr> </thead> <tbody> <tr> <td>0H2213A1</td> <td>HOOD WATER CIRCUIT PLAT</td> <td>1.000</td> <td>PC</td> </tr> <tr> <td>EL1440A0</td> <td>WATER SELF CLEANING VALVE</td> <td>2.000</td> <td>PC</td> </tr> <tr> <td>GN1526A0</td> <td>INT. D.=6.9 TH=1.8 O-RIN</td> <td>5.000</td> <td>PC</td> </tr> <tr> <td>RC1018A0</td> <td>ZINC PLATED D12 ELASTIC CLAMP</td> <td>1.000</td> <td>PC</td> </tr> <tr> <td>RC1019A0</td> <td>D=10 ELASTIC CLAMP</td> <td>14.000</td> <td>PC</td> </tr> <tr> <td>RC1131A0</td> <td>200x2.6 BLACK CLAMP</td> <td>1.000</td> <td>PC</td> </tr> <tr> <td>RC1242A0</td> <td>D=10 CLOSED CAP</td> <td>2.000</td> <td>PC</td> </tr> <tr> <td>RC1414A1</td> <td>D11.5-12.5 SINGLE EAR HOSE CLAMP</td> <td>3.000</td> <td>PC</td> </tr> </tbody> </table>	Code	Description	Qty	UOM	0H2213A1	HOOD WATER CIRCUIT PLAT	1.000	PC	EL1440A0	WATER SELF CLEANING VALVE	2.000	PC	GN1526A0	INT. D.=6.9 TH=1.8 O-RIN	5.000	PC	RC1018A0	ZINC PLATED D12 ELASTIC CLAMP	1.000	PC	RC1019A0	D=10 ELASTIC CLAMP	14.000	PC	RC1131A0	200x2.6 BLACK CLAMP	1.000	PC	RC1242A0	D=10 CLOSED CAP	2.000	PC	RC1414A1	D11.5-12.5 SINGLE EAR HOSE CLAMP	3.000	PC
			Code		Description	Qty	UOM																																																																																					
VL1102A1	DETERGENT LINE FILTER + BARBED VNR 6 MM	1.000	PC																																																																																									
VL1127A1	6mm BARBED T-SHAPED FITTING	1.000	PC																																																																																									
VL1128A1	D6 BARBED CHECK VALVE	1.000	PC																																																																																									
VL1166A0	BB6-AR6 L FITTING	3.000	PC																																																																																									
VL1174C0	D1.2 MM CALIBRATED NOZZLE	1.000	PC																																																																																									
VL1185A0	2 WAYS PLUS WASHING DISTRIBUTOR	1.000	PC																																																																																									
VL1190A0	PLUS WASHING SYSTEM INLET DISTRIBUTOR	1.000	PC																																																																																									
VL1214A0	BAYONET - 6mm BARBED NRV VALVE	1.000	PC																																																																																									
VL1398A0	1/4 M N.O. CIL PRESSURE SWITCH	1.000	PC																																																																																									
VM1605A0	CLIP TWIST LOCK DIAM. 10.2-12.7 MM	3.000	PC																																																																																									
VM2172A0	LOCKING CLIP FOR PUMP WITH CIRCUIT	4.000	PC																																																																																									
Code	Description	Qty	UOM																																																																																									
0H2213A1	HOOD WATER CIRCUIT PLAT	1.000	PC																																																																																									
EL1440A0	WATER SELF CLEANING VALVE	2.000	PC																																																																																									
GN1526A0	INT. D.=6.9 TH=1.8 O-RIN	5.000	PC																																																																																									
RC1018A0	ZINC PLATED D12 ELASTIC CLAMP	1.000	PC																																																																																									
RC1019A0	D=10 ELASTIC CLAMP	14.000	PC																																																																																									
RC1131A0	200x2.6 BLACK CLAMP	1.000	PC																																																																																									
RC1242A0	D=10 CLOSED CAP	2.000	PC																																																																																									
RC1414A1	D11.5-12.5 SINGLE EAR HOSE CLAMP	3.000	PC																																																																																									

COMPONENT			SPARE PART																																																																																		
Code	Description	Image	Code	Description	Kit components																																																																																
VL1019A	VIBRATION DETERGENT PUMP		KVL1198A	MM EU HOOD CLEANING SYSTEM KIT	<table border="1"> <thead> <tr> <th>Code</th> <th>Description</th> <th>Qty</th> <th>UOM</th> </tr> </thead> <tbody> <tr> <td>TB2821A0</td> <td>EPDM 6X10 L=40MM PIPE</td> <td>4.000</td> <td>PC</td> </tr> <tr> <td>TB2994A0</td> <td>HOOD DETERGENT PIPE</td> <td>2.000</td> <td>PC</td> </tr> <tr> <td>TB3252A0</td> <td>TB3252A0</td> <td>2.000</td> <td>PC</td> </tr> <tr> <td>TB3614A0</td> <td>TB3614A0</td> <td>1.000</td> <td>PC</td> </tr> <tr> <td>VI1220A1</td> <td>4,2x12 TCB SELF-TAPPIN G SCREW</td> <td>3.000</td> <td>PC</td> </tr> <tr> <td>VI2070A0</td> <td>SHEETTRACS TCB+ 40x8 SELF-THREAD SCREW</td> <td>2.000</td> <td>PC</td> </tr> <tr> <td>VL1019A0</td> <td>VIBRATION DETERGENT PUMP</td> <td>1.000</td> <td>PC</td> </tr> <tr> <td>VL1047A1</td> <td>D6 PIPE HOLDER - D8 J.G. TERMINAL</td> <td>2.000</td> <td>PC</td> </tr> <tr> <td>VL1054B0</td> <td>ONE WASHING SYS INLET DISTRIBUTOR</td> <td>1.000</td> <td>PC</td> </tr> <tr> <td>VL1102A1</td> <td>DETERGENT LINE FILTER + BARBED VNR 6 MM</td> <td>1.000</td> <td>PC</td> </tr> <tr> <td>VL1127A1</td> <td>6mm BARBED T-SHAPED FITTING</td> <td>1.000</td> <td>PC</td> </tr> <tr> <td>VL1128A1</td> <td>D6 BARBED CHECK VALVE</td> <td>1.000</td> <td>PC</td> </tr> <tr> <td>VL1165A0</td> <td>BAM-BB6 STRAIGHT FITTING</td> <td>1.000</td> <td>PC</td> </tr> <tr> <td>VL1166A0</td> <td>BB6-AR6 L FITTING</td> <td>2.000</td> <td>PC</td> </tr> <tr> <td>VL1174C0</td> <td>D1.2 MM CALIBRATED NOZZLE</td> <td>1.000</td> <td>PC</td> </tr> <tr> <td>VL1191A0</td> <td>ONE WASHING DISTRIBUTOR OUTLETS KIT</td> <td>1.000</td> <td>PC</td> </tr> <tr> <td>VL1214A0</td> <td>BAYONET - 6mm BARBED NRV VALVE</td> <td>1.000</td> <td>PC</td> </tr> <tr> <td>VM1605A0</td> <td>CLIP TWIST LOCK DIAM. 10,2-12,7 MM</td> <td>2.000</td> <td>PC</td> </tr> <tr> <td>VM2172A0</td> <td>LOCKING CLIP FOR PUMP WITH CIRCUIT</td> <td>3.000</td> <td>PC</td> </tr> </tbody> </table>	Code	Description	Qty	UOM	TB2821A0	EPDM 6X10 L=40MM PIPE	4.000	PC	TB2994A0	HOOD DETERGENT PIPE	2.000	PC	TB3252A0	TB3252A0	2.000	PC	TB3614A0	TB3614A0	1.000	PC	VI1220A1	4,2x12 TCB SELF-TAPPIN G SCREW	3.000	PC	VI2070A0	SHEETTRACS TCB+ 40x8 SELF-THREAD SCREW	2.000	PC	VL1019A0	VIBRATION DETERGENT PUMP	1.000	PC	VL1047A1	D6 PIPE HOLDER - D8 J.G. TERMINAL	2.000	PC	VL1054B0	ONE WASHING SYS INLET DISTRIBUTOR	1.000	PC	VL1102A1	DETERGENT LINE FILTER + BARBED VNR 6 MM	1.000	PC	VL1127A1	6mm BARBED T-SHAPED FITTING	1.000	PC	VL1128A1	D6 BARBED CHECK VALVE	1.000	PC	VL1165A0	BAM-BB6 STRAIGHT FITTING	1.000	PC	VL1166A0	BB6-AR6 L FITTING	2.000	PC	VL1174C0	D1.2 MM CALIBRATED NOZZLE	1.000	PC	VL1191A0	ONE WASHING DISTRIBUTOR OUTLETS KIT	1.000	PC	VL1214A0	BAYONET - 6mm BARBED NRV VALVE	1.000	PC	VM1605A0	CLIP TWIST LOCK DIAM. 10,2-12,7 MM	2.000	PC	VM2172A0	LOCKING CLIP FOR PUMP WITH CIRCUIT	3.000	PC
Code	Description	Qty	UOM																																																																																		
TB2821A0	EPDM 6X10 L=40MM PIPE	4.000	PC																																																																																		
TB2994A0	HOOD DETERGENT PIPE	2.000	PC																																																																																		
TB3252A0	TB3252A0	2.000	PC																																																																																		
TB3614A0	TB3614A0	1.000	PC																																																																																		
VI1220A1	4,2x12 TCB SELF-TAPPIN G SCREW	3.000	PC																																																																																		
VI2070A0	SHEETTRACS TCB+ 40x8 SELF-THREAD SCREW	2.000	PC																																																																																		
VL1019A0	VIBRATION DETERGENT PUMP	1.000	PC																																																																																		
VL1047A1	D6 PIPE HOLDER - D8 J.G. TERMINAL	2.000	PC																																																																																		
VL1054B0	ONE WASHING SYS INLET DISTRIBUTOR	1.000	PC																																																																																		
VL1102A1	DETERGENT LINE FILTER + BARBED VNR 6 MM	1.000	PC																																																																																		
VL1127A1	6mm BARBED T-SHAPED FITTING	1.000	PC																																																																																		
VL1128A1	D6 BARBED CHECK VALVE	1.000	PC																																																																																		
VL1165A0	BAM-BB6 STRAIGHT FITTING	1.000	PC																																																																																		
VL1166A0	BB6-AR6 L FITTING	2.000	PC																																																																																		
VL1174C0	D1.2 MM CALIBRATED NOZZLE	1.000	PC																																																																																		
VL1191A0	ONE WASHING DISTRIBUTOR OUTLETS KIT	1.000	PC																																																																																		
VL1214A0	BAYONET - 6mm BARBED NRV VALVE	1.000	PC																																																																																		
VM1605A0	CLIP TWIST LOCK DIAM. 10,2-12,7 MM	2.000	PC																																																																																		
VM2172A0	LOCKING CLIP FOR PUMP WITH CIRCUIT	3.000	PC																																																																																		



COMPONENT			SPARE PART																																																																																																	
Code	Description	Image	Code	Description	Kit components																																																																																															
VL1019A	VIBRATION DETERGENT PUMP		KVL1187A	3 ROTOR ARMS PLUS EU CLEANING SYSTEM KIT	<table border="1"> <thead> <tr> <th>Code</th> <th>Description</th> <th>Qty</th> <th>UOM</th> </tr> </thead> <tbody> <tr> <td>0H2354A1</td> <td>XEVC-XEVL PLUS WASHING CIRCUIT PLAT</td> <td>1.000</td> <td>PC</td> </tr> <tr> <td>EL1440A0</td> <td>WATER SELF CLEANING VALVE</td> <td>4.000</td> <td>PC</td> </tr> <tr> <td>GN1526A0</td> <td>INT. D.=6.9 TH=1.8 O-RIN</td> <td>9.000</td> <td>PC</td> </tr> <tr> <td>RC1018A0</td> <td>ZINC PLATED D12 ELASTIC CLAMP</td> <td>11.000</td> <td>PC</td> </tr> <tr> <td>RC1019A0</td> <td>D=10 ELASTIC CLAMP</td> <td>14.000</td> <td>PC</td> </tr> <tr> <td>RC1130A0</td> <td>130x2.6 CLAM</td> <td>1.000</td> <td>PC</td> </tr> <tr> <td>RC1131A0</td> <td>200x2.6 BLACK CLAMP</td> <td>3.000</td> <td>PC</td> </tr> <tr> <td>RC1242A0</td> <td>D=10 CLOSED CAP</td> <td>2.000</td> <td>PC</td> </tr> <tr> <td>RC1356A0</td> <td>"STRAIGHT THREADED FEMALE END 8x1/4" BS</td> <td>1.000</td> <td>PC</td> </tr> <tr> <td>RC1414A1</td> <td>D11.5-12.5 SINGLE EAR HOSE CLAMP</td> <td>1.000</td> <td>PC</td> </tr> <tr> <td>TB2652A0</td> <td></td> <td>1.000</td> <td>PC</td> </tr> <tr> <td>TB2677A0</td> <td></td> <td>1.000</td> <td>PC</td> </tr> <tr> <td>TB2821A0</td> <td>EPDM 6X10 L=40MM PIPE</td> <td>4.000</td> <td>PC</td> </tr> <tr> <td>TB3004A0</td> <td>TB2820A L=550mm EPDM BLACK PIPE</td> <td>2.000</td> <td>PC</td> </tr> <tr> <td>TB3024C0</td> <td></td> <td>3.000</td> <td>PC</td> </tr> <tr> <td>TB3226A0</td> <td></td> <td>1.000</td> <td>PC</td> </tr> <tr> <td>TB3440A0</td> <td>TB3132A L=1050mm EPDM WHITE-BLUE PIPE</td> <td>1.000</td> <td>PC</td> </tr> <tr> <td>TB3614A0</td> <td>TB3614A0</td> <td>1.000</td> <td>PC</td> </tr> <tr> <td>VI1220A1</td> <td>4,2x12 TCB SELF-TAPPIN G SCREW</td> <td>1.000</td> <td>PC</td> </tr> <tr> <td>VL1019A0</td> <td>VIBRATION DETERGENT PUMP</td> <td></td> <td>1.000</td> <td>PC</td> </tr> <tr> <td>VL1047A1</td> <td>D6 PIPE HOLDER - D8 J.G. TERMINAL</td> <td></td> <td>1.000</td> <td>PC</td> </tr> <tr> <td>VL1065A1</td> <td>1/4 MALE N.O. PRESSURE SWITCH</td> <td></td> <td>1.000</td> <td>PC</td> </tr> </tbody> </table>	Code	Description	Qty	UOM	0H2354A1	XEVC-XEVL PLUS WASHING CIRCUIT PLAT	1.000	PC	EL1440A0	WATER SELF CLEANING VALVE	4.000	PC	GN1526A0	INT. D.=6.9 TH=1.8 O-RIN	9.000	PC	RC1018A0	ZINC PLATED D12 ELASTIC CLAMP	11.000	PC	RC1019A0	D=10 ELASTIC CLAMP	14.000	PC	RC1130A0	130x2.6 CLAM	1.000	PC	RC1131A0	200x2.6 BLACK CLAMP	3.000	PC	RC1242A0	D=10 CLOSED CAP	2.000	PC	RC1356A0	"STRAIGHT THREADED FEMALE END 8x1/4" BS	1.000	PC	RC1414A1	D11.5-12.5 SINGLE EAR HOSE CLAMP	1.000	PC	TB2652A0		1.000	PC	TB2677A0		1.000	PC	TB2821A0	EPDM 6X10 L=40MM PIPE	4.000	PC	TB3004A0	TB2820A L=550mm EPDM BLACK PIPE	2.000	PC	TB3024C0		3.000	PC	TB3226A0		1.000	PC	TB3440A0	TB3132A L=1050mm EPDM WHITE-BLUE PIPE	1.000	PC	TB3614A0	TB3614A0	1.000	PC	VI1220A1	4,2x12 TCB SELF-TAPPIN G SCREW	1.000	PC	VL1019A0	VIBRATION DETERGENT PUMP		1.000	PC	VL1047A1	D6 PIPE HOLDER - D8 J.G. TERMINAL		1.000	PC	VL1065A1	1/4 MALE N.O. PRESSURE SWITCH		1.000	PC
Code	Description	Qty	UOM																																																																																																	
0H2354A1	XEVC-XEVL PLUS WASHING CIRCUIT PLAT	1.000	PC																																																																																																	
EL1440A0	WATER SELF CLEANING VALVE	4.000	PC																																																																																																	
GN1526A0	INT. D.=6.9 TH=1.8 O-RIN	9.000	PC																																																																																																	
RC1018A0	ZINC PLATED D12 ELASTIC CLAMP	11.000	PC																																																																																																	
RC1019A0	D=10 ELASTIC CLAMP	14.000	PC																																																																																																	
RC1130A0	130x2.6 CLAM	1.000	PC																																																																																																	
RC1131A0	200x2.6 BLACK CLAMP	3.000	PC																																																																																																	
RC1242A0	D=10 CLOSED CAP	2.000	PC																																																																																																	
RC1356A0	"STRAIGHT THREADED FEMALE END 8x1/4" BS	1.000	PC																																																																																																	
RC1414A1	D11.5-12.5 SINGLE EAR HOSE CLAMP	1.000	PC																																																																																																	
TB2652A0		1.000	PC																																																																																																	
TB2677A0		1.000	PC																																																																																																	
TB2821A0	EPDM 6X10 L=40MM PIPE	4.000	PC																																																																																																	
TB3004A0	TB2820A L=550mm EPDM BLACK PIPE	2.000	PC																																																																																																	
TB3024C0		3.000	PC																																																																																																	
TB3226A0		1.000	PC																																																																																																	
TB3440A0	TB3132A L=1050mm EPDM WHITE-BLUE PIPE	1.000	PC																																																																																																	
TB3614A0	TB3614A0	1.000	PC																																																																																																	
VI1220A1	4,2x12 TCB SELF-TAPPIN G SCREW	1.000	PC																																																																																																	
VL1019A0	VIBRATION DETERGENT PUMP		1.000	PC																																																																																																
VL1047A1	D6 PIPE HOLDER - D8 J.G. TERMINAL		1.000	PC																																																																																																
VL1065A1	1/4 MALE N.O. PRESSURE SWITCH		1.000	PC																																																																																																



COMPONENT			SPARE PART																																																																																					
Code	Description	Image	Code	Description	Kit components																																																																																			
VL1019A	VIBRATION DETERGENT PUMP		KVL1187A	3 ROTOR ARMS PLUS EU CLEANING SYSTEM KIT	<table border="1"> <thead> <tr> <th>Code</th> <th>Description</th> <th>Qty</th> <th>UOM</th> </tr> </thead> <tbody> <tr> <td>VL1102A1</td> <td>DETERGENT LINE FILTER + BARBED VNR 6 MM</td> <td>1.000</td> <td>PC</td> </tr> <tr> <td>VL1127A1</td> <td>6mm BARBED T-SHAPED FITTING</td> <td>2.000</td> <td>PC</td> </tr> <tr> <td>VL1128A1</td> <td>D6 BARBED CHECK VALVE</td> <td>2.000</td> <td>PC</td> </tr> <tr> <td>VL1166A0</td> <td>BB6-AR6 L FITTING</td> <td>4.000</td> <td>PC</td> </tr> <tr> <td>VL1167A2</td> <td>GN21 3 ROTOR ARMS B-B FLOW RESTRICTOR</td> <td>1.000</td> <td>PC</td> </tr> <tr> <td>VL1174C0</td> <td>D1.2 MM CALIBRATED NOZZLE</td> <td>1.000</td> <td>PC</td> </tr> <tr> <td>VL1186A0</td> <td>3 WAYS PLUS WASHING DISTRIBUTOR</td> <td>1.000</td> <td>PC</td> </tr> <tr> <td>VL1190A0</td> <td>PLUS WASHING SYSTEM INLET DISTRIBUTOR</td> <td>1.000</td> <td>PC</td> </tr> <tr> <td>VL1214A0</td> <td>BAYONET - 6mm BARBED NRV VALVE</td> <td>1.000</td> <td>PC</td> </tr> <tr> <td>VM1605A0</td> <td>CLIP TWIST LOCK DIAM. 10,2-12,7 MM</td> <td>3.000</td> <td>PC</td> </tr> <tr> <td>VM2172A0</td> <td>LOCKING CLIP FOR PUMP WITH CIRCUIT</td> <td>5.000</td> <td>PC</td> </tr> </tbody> </table>	Code	Description	Qty	UOM	VL1102A1	DETERGENT LINE FILTER + BARBED VNR 6 MM	1.000	PC	VL1127A1	6mm BARBED T-SHAPED FITTING	2.000	PC	VL1128A1	D6 BARBED CHECK VALVE	2.000	PC	VL1166A0	BB6-AR6 L FITTING	4.000	PC	VL1167A2	GN21 3 ROTOR ARMS B-B FLOW RESTRICTOR	1.000	PC	VL1174C0	D1.2 MM CALIBRATED NOZZLE	1.000	PC	VL1186A0	3 WAYS PLUS WASHING DISTRIBUTOR	1.000	PC	VL1190A0	PLUS WASHING SYSTEM INLET DISTRIBUTOR	1.000	PC	VL1214A0	BAYONET - 6mm BARBED NRV VALVE	1.000	PC	VM1605A0	CLIP TWIST LOCK DIAM. 10,2-12,7 MM	3.000	PC	VM2172A0	LOCKING CLIP FOR PUMP WITH CIRCUIT	5.000	PC	KVL1184A	2 ROTOR ARMS PLUS EU CLEANING SYSTEM KIT	<table border="1"> <thead> <tr> <th>Code</th> <th>Description</th> <th>Qty</th> <th>UOM</th> </tr> </thead> <tbody> <tr> <td>0H2354A1</td> <td>XEVC-XEVL PLUS WASHING CIRCUIT PLAT</td> <td>1.000</td> <td>PC</td> </tr> <tr> <td>EL1440A0</td> <td>WATER SELF CLEANING VALVE</td> <td>4.000</td> <td>PC</td> </tr> <tr> <td>GN1526A0</td> <td>INT. D.=6.9 TH=1.8 O-RIN</td> <td>9.000</td> <td>PC</td> </tr> <tr> <td>RC1018A0</td> <td>ZINC PLATED D12 ELASTIC CLAMP</td> <td>2.000</td> <td>PC</td> </tr> <tr> <td>RC1019A0</td> <td>D=10 ELASTIC CLAMP</td> <td>13.000</td> <td>PC</td> </tr> <tr> <td>RC1130A0</td> <td>130x2,6 CLAM</td> <td>1.000</td> <td>PC</td> </tr> <tr> <td>RC1131A0</td> <td>200x2,6 BLACK CLAMP</td> <td>3.000</td> <td>PC</td> </tr> </tbody> </table>	Code	Description	Qty	UOM	0H2354A1	XEVC-XEVL PLUS WASHING CIRCUIT PLAT	1.000	PC	EL1440A0	WATER SELF CLEANING VALVE	4.000	PC	GN1526A0	INT. D.=6.9 TH=1.8 O-RIN	9.000	PC	RC1018A0	ZINC PLATED D12 ELASTIC CLAMP	2.000	PC	RC1019A0	D=10 ELASTIC CLAMP	13.000	PC	RC1130A0	130x2,6 CLAM	1.000	PC	RC1131A0	200x2,6 BLACK CLAMP	3.000	PC
			Code	Description	Qty	UOM																																																																																		
VL1102A1	DETERGENT LINE FILTER + BARBED VNR 6 MM	1.000	PC																																																																																					
VL1127A1	6mm BARBED T-SHAPED FITTING	2.000	PC																																																																																					
VL1128A1	D6 BARBED CHECK VALVE	2.000	PC																																																																																					
VL1166A0	BB6-AR6 L FITTING	4.000	PC																																																																																					
VL1167A2	GN21 3 ROTOR ARMS B-B FLOW RESTRICTOR	1.000	PC																																																																																					
VL1174C0	D1.2 MM CALIBRATED NOZZLE	1.000	PC																																																																																					
VL1186A0	3 WAYS PLUS WASHING DISTRIBUTOR	1.000	PC																																																																																					
VL1190A0	PLUS WASHING SYSTEM INLET DISTRIBUTOR	1.000	PC																																																																																					
VL1214A0	BAYONET - 6mm BARBED NRV VALVE	1.000	PC																																																																																					
VM1605A0	CLIP TWIST LOCK DIAM. 10,2-12,7 MM	3.000	PC																																																																																					
VM2172A0	LOCKING CLIP FOR PUMP WITH CIRCUIT	5.000	PC																																																																																					
Code	Description	Qty	UOM																																																																																					
0H2354A1	XEVC-XEVL PLUS WASHING CIRCUIT PLAT	1.000	PC																																																																																					
EL1440A0	WATER SELF CLEANING VALVE	4.000	PC																																																																																					
GN1526A0	INT. D.=6.9 TH=1.8 O-RIN	9.000	PC																																																																																					
RC1018A0	ZINC PLATED D12 ELASTIC CLAMP	2.000	PC																																																																																					
RC1019A0	D=10 ELASTIC CLAMP	13.000	PC																																																																																					
RC1130A0	130x2,6 CLAM	1.000	PC																																																																																					
RC1131A0	200x2,6 BLACK CLAMP	3.000	PC																																																																																					

COMPONENT			SPARE PART																																																																														
Code	Description	Image	Code	Description	Kit components																																																																												
VL1019A	VIBRATION DETERGENT PUMP		KVL1184A	2 ROTOR ARMS PLUS EU CLEANING SYSTEM KIT	<table border="1"> <thead> <tr> <th>Code</th> <th>Description</th> <th>Qty</th> <th>UOM</th> </tr> </thead> <tbody> <tr> <td>RC1242A0</td> <td>D=10 CLOSED CAP</td> <td>2.000</td> <td>PC</td> </tr> <tr> <td>RC1356A0</td> <td>"STRAIGHT THREADED FEMALE END 8x1/4" BS</td> <td>1.000</td> <td>PC</td> </tr> <tr> <td>RC1414A1</td> <td>D11.5-12.5 SINGLE EAR HOSE CLAMP</td> <td>1.000</td> <td>PC</td> </tr> <tr> <td>TB2821A0</td> <td>EPDM 6X10 L=40MM PIPE</td> <td>4.000</td> <td>PC</td> </tr> <tr> <td>TB2994A0</td> <td>HOOD DETERGENT PIPE</td> <td>1.000</td> <td>PC</td> </tr> <tr> <td>TB3004A0</td> <td>TB2820A L=550mm EPDM BLACK PIPE</td> <td>2.000</td> <td>PC</td> </tr> <tr> <td>TB3005B0</td> <td>TB3132A L=550mm EPDM WHITE-BLUE PIPE</td> <td>1.000</td> <td>PC</td> </tr> <tr> <td>TB3440A0</td> <td>TB3132A L=1050mm EPDM WHITE-BLUE PIPE</td> <td>1.000</td> <td>PC</td> </tr> <tr> <td>TB3614A0</td> <td>TB3614A0</td> <td>1.000</td> <td>PC</td> </tr> <tr> <td>VI1220A1</td> <td>4,2x12 TCB SELF-TAPPIN G SCREW</td> <td>1.000</td> <td>PC</td> </tr> <tr> <td>VL1019A0</td> <td>VIBRATION DETERGENT PUMP</td> <td>1.000</td> <td>PC</td> </tr> <tr> <td>VL1047A1</td> <td>D6 PIPE HOLDER - D6 J.G. TERMINAL</td> <td>1.000</td> <td>PC</td> </tr> <tr> <td>VL1065A1</td> <td>1/4 MALE N.O. PRESSURE SWITCH</td> <td>1.000</td> <td>PC</td> </tr> <tr> <td>VL1102A1</td> <td>DETERGENT LINE FILTER + BARBED VNR 6 MM</td> <td>1.000</td> <td>PC</td> </tr> <tr> <td>VL1128A1</td> <td>D6 BARBED CHECK VALVE</td> <td>1.000</td> <td>PC</td> </tr> <tr> <td>VL1166A0</td> <td>BB6-AR6 L FITTING</td> <td>4.000</td> <td>PC</td> </tr> <tr> <td>VL1174C0</td> <td>D1.2 MM CALIBRATED NOZZLE</td> <td>1.000</td> <td>PC</td> </tr> <tr> <td>VL1186A0</td> <td>3 WAYS PLUS WASHING DISTRIBUTOR</td> <td>1.000</td> <td>PC</td> </tr> </tbody> </table>	Code	Description	Qty	UOM	RC1242A0	D=10 CLOSED CAP	2.000	PC	RC1356A0	"STRAIGHT THREADED FEMALE END 8x1/4" BS	1.000	PC	RC1414A1	D11.5-12.5 SINGLE EAR HOSE CLAMP	1.000	PC	TB2821A0	EPDM 6X10 L=40MM PIPE	4.000	PC	TB2994A0	HOOD DETERGENT PIPE	1.000	PC	TB3004A0	TB2820A L=550mm EPDM BLACK PIPE	2.000	PC	TB3005B0	TB3132A L=550mm EPDM WHITE-BLUE PIPE	1.000	PC	TB3440A0	TB3132A L=1050mm EPDM WHITE-BLUE PIPE	1.000	PC	TB3614A0	TB3614A0	1.000	PC	VI1220A1	4,2x12 TCB SELF-TAPPIN G SCREW	1.000	PC	VL1019A0	VIBRATION DETERGENT PUMP	1.000	PC	VL1047A1	D6 PIPE HOLDER - D6 J.G. TERMINAL	1.000	PC	VL1065A1	1/4 MALE N.O. PRESSURE SWITCH	1.000	PC	VL1102A1	DETERGENT LINE FILTER + BARBED VNR 6 MM	1.000	PC	VL1128A1	D6 BARBED CHECK VALVE	1.000	PC	VL1166A0	BB6-AR6 L FITTING	4.000	PC	VL1174C0	D1.2 MM CALIBRATED NOZZLE	1.000	PC	VL1186A0	3 WAYS PLUS WASHING DISTRIBUTOR	1.000	PC
Code	Description	Qty	UOM																																																																														
RC1242A0	D=10 CLOSED CAP	2.000	PC																																																																														
RC1356A0	"STRAIGHT THREADED FEMALE END 8x1/4" BS	1.000	PC																																																																														
RC1414A1	D11.5-12.5 SINGLE EAR HOSE CLAMP	1.000	PC																																																																														
TB2821A0	EPDM 6X10 L=40MM PIPE	4.000	PC																																																																														
TB2994A0	HOOD DETERGENT PIPE	1.000	PC																																																																														
TB3004A0	TB2820A L=550mm EPDM BLACK PIPE	2.000	PC																																																																														
TB3005B0	TB3132A L=550mm EPDM WHITE-BLUE PIPE	1.000	PC																																																																														
TB3440A0	TB3132A L=1050mm EPDM WHITE-BLUE PIPE	1.000	PC																																																																														
TB3614A0	TB3614A0	1.000	PC																																																																														
VI1220A1	4,2x12 TCB SELF-TAPPIN G SCREW	1.000	PC																																																																														
VL1019A0	VIBRATION DETERGENT PUMP	1.000	PC																																																																														
VL1047A1	D6 PIPE HOLDER - D6 J.G. TERMINAL	1.000	PC																																																																														
VL1065A1	1/4 MALE N.O. PRESSURE SWITCH	1.000	PC																																																																														
VL1102A1	DETERGENT LINE FILTER + BARBED VNR 6 MM	1.000	PC																																																																														
VL1128A1	D6 BARBED CHECK VALVE	1.000	PC																																																																														
VL1166A0	BB6-AR6 L FITTING	4.000	PC																																																																														
VL1174C0	D1.2 MM CALIBRATED NOZZLE	1.000	PC																																																																														
VL1186A0	3 WAYS PLUS WASHING DISTRIBUTOR	1.000	PC																																																																														



COMPONENT			SPARE PART																																																							
Code	Description	Image	Code	Description	Kit components																																																					
VL1019A	VIBRATION DETERGENT PUMP		KVL1184A	2 ROTOR ARMS PLUS EU CLEANING SYSTEM KIT	<table border="1"> <thead> <tr> <th>Code</th> <th>Description</th> <th>Qty</th> <th>UOM</th> </tr> </thead> <tbody> <tr> <td>VL1190A0</td> <td>PLUS WASHING SYSTEM INLET DISTRIBUTOR</td> <td>1.000</td> <td>PC</td> </tr> <tr> <td>VL1214A0</td> <td>BAYONET - 6mm BARBED NRV VALVE</td> <td>1.000</td> <td>PC</td> </tr> <tr> <td>VM1605A0</td> <td>CLIP TWIST LOCK DIAM. 10,2-12,7 MM</td> <td>3.000</td> <td>PC</td> </tr> <tr> <td>VM2172A0</td> <td>LOCKING CLIP FOR PUMP WITH CIRCUIT</td> <td>5.000</td> <td>PC</td> </tr> </tbody> </table>	Code	Description	Qty	UOM	VL1190A0	PLUS WASHING SYSTEM INLET DISTRIBUTOR	1.000	PC	VL1214A0	BAYONET - 6mm BARBED NRV VALVE	1.000	PC	VM1605A0	CLIP TWIST LOCK DIAM. 10,2-12,7 MM	3.000	PC	VM2172A0	LOCKING CLIP FOR PUMP WITH CIRCUIT	5.000	PC																																	
			Code	Description	Qty	UOM																																																				
VL1190A0	PLUS WASHING SYSTEM INLET DISTRIBUTOR	1.000	PC																																																							
VL1214A0	BAYONET - 6mm BARBED NRV VALVE	1.000	PC																																																							
VM1605A0	CLIP TWIST LOCK DIAM. 10,2-12,7 MM	3.000	PC																																																							
VM2172A0	LOCKING CLIP FOR PUMP WITH CIRCUIT	5.000	PC																																																							
KVL1183A	1 ROTOR ARM PLUS CLEANING SYSTEM KIT	<table border="1"> <thead> <tr> <th>Code</th> <th>Description</th> <th>Qty</th> <th>UOM</th> </tr> </thead> <tbody> <tr> <td>0H2354A1</td> <td>XEVC-XEVL PLUS WASHING CIRCUIT PLAT</td> <td>1.000</td> <td>PC</td> </tr> <tr> <td>EL1440A0</td> <td>WATER SELF CLEANING VALVE</td> <td>3.000</td> <td>PC</td> </tr> <tr> <td>GN1526A0</td> <td>INT. D.=6.9 TH=1.8 O-RIN</td> <td>7.000</td> <td>PC</td> </tr> <tr> <td>RC1018A0</td> <td>ZINC PLATED D12 ELASTIC CLAMP</td> <td>1.000</td> <td>PC</td> </tr> <tr> <td>RC1019A0</td> <td>D=10 ELASTIC CLAMP</td> <td>12.000</td> <td>PC</td> </tr> <tr> <td>RC1130A0</td> <td>130x2.6 CLAM</td> <td>1.000</td> <td>PC</td> </tr> <tr> <td>RC1131A0</td> <td>200x2.6 BLACK CLAMP</td> <td>2.000</td> <td>PC</td> </tr> <tr> <td>RC1242A0</td> <td>D=10 CLOSED CAP</td> <td>2.000</td> <td>PC</td> </tr> <tr> <td>RC1356A0</td> <td>"STRAIGHT THREADED FEMALE END 8x1/4" BS</td> <td>1.000</td> <td>PC</td> </tr> <tr> <td>RC1414A1</td> <td>D11.5-12.5 SINGLE EAR HOSE CLAMP</td> <td>1.000</td> <td>PC</td> </tr> <tr> <td>TB2821A0</td> <td>EPDM 6X10 L=40MM PIPE</td> <td>4.000</td> <td>PC</td> </tr> <tr> <td>TB3004A0</td> <td>TB2820A L=550mm EPDM BLACK PIPE</td> <td>1.000</td> <td>PC</td> </tr> <tr> <td>TB3005B0</td> <td>TB3132A L=550mm EPDM WHITE-BLUE PIPE</td> <td>1.000</td> <td>PC</td> </tr> </tbody> </table>	Code	Description	Qty	UOM	0H2354A1	XEVC-XEVL PLUS WASHING CIRCUIT PLAT	1.000	PC	EL1440A0	WATER SELF CLEANING VALVE	3.000	PC	GN1526A0	INT. D.=6.9 TH=1.8 O-RIN	7.000	PC	RC1018A0	ZINC PLATED D12 ELASTIC CLAMP	1.000	PC	RC1019A0	D=10 ELASTIC CLAMP	12.000	PC	RC1130A0	130x2.6 CLAM	1.000	PC	RC1131A0	200x2.6 BLACK CLAMP	2.000	PC	RC1242A0	D=10 CLOSED CAP	2.000	PC	RC1356A0	"STRAIGHT THREADED FEMALE END 8x1/4" BS	1.000	PC	RC1414A1	D11.5-12.5 SINGLE EAR HOSE CLAMP	1.000	PC	TB2821A0	EPDM 6X10 L=40MM PIPE	4.000	PC	TB3004A0	TB2820A L=550mm EPDM BLACK PIPE	1.000	PC	TB3005B0	TB3132A L=550mm EPDM WHITE-BLUE PIPE	1.000	PC
Code	Description	Qty	UOM																																																							
0H2354A1	XEVC-XEVL PLUS WASHING CIRCUIT PLAT	1.000	PC																																																							
EL1440A0	WATER SELF CLEANING VALVE	3.000	PC																																																							
GN1526A0	INT. D.=6.9 TH=1.8 O-RIN	7.000	PC																																																							
RC1018A0	ZINC PLATED D12 ELASTIC CLAMP	1.000	PC																																																							
RC1019A0	D=10 ELASTIC CLAMP	12.000	PC																																																							
RC1130A0	130x2.6 CLAM	1.000	PC																																																							
RC1131A0	200x2.6 BLACK CLAMP	2.000	PC																																																							
RC1242A0	D=10 CLOSED CAP	2.000	PC																																																							
RC1356A0	"STRAIGHT THREADED FEMALE END 8x1/4" BS	1.000	PC																																																							
RC1414A1	D11.5-12.5 SINGLE EAR HOSE CLAMP	1.000	PC																																																							
TB2821A0	EPDM 6X10 L=40MM PIPE	4.000	PC																																																							
TB3004A0	TB2820A L=550mm EPDM BLACK PIPE	1.000	PC																																																							
TB3005B0	TB3132A L=550mm EPDM WHITE-BLUE PIPE	1.000	PC																																																							



COMPONENT			SPARE PART																																																																																	
Code	Description	Image	Code	Description	Kit components																																																																															
VL1019A	VIBRATION DETERGENT PUMP		KVL1183A	1 ROTOR ARM PLUS CLEANING SYSTEM KIT	<table border="1"> <thead> <tr> <th>Code</th> <th>Description</th> <th>Qty</th> <th>UOM</th> </tr> </thead> <tbody> <tr> <td>TB3225B0</td> <td>TB2820A-TAN K-WASHYNG SYS CONNECTION</td> <td>1.000</td> <td>PC</td> </tr> <tr> <td>TB3252A0</td> <td>TB3252A0</td> <td>1.000</td> <td>PC</td> </tr> <tr> <td>TB3614A0</td> <td>TB3614A0</td> <td>1.000</td> <td>PC</td> </tr> <tr> <td>VI1220A1</td> <td>4,2x12 TCB SELF-TAPPIN G SCREW</td> <td>1.000</td> <td>PC</td> </tr> <tr> <td>VL1019A0</td> <td>VIBRATION DETERGENT PUMP</td> <td>1.000</td> <td>PC</td> </tr> <tr> <td>VL1047A1</td> <td>D6 PIPE HOLDER - D8 J.G. TERMINAL</td> <td>1.000</td> <td>PC</td> </tr> <tr> <td>VL1102A1</td> <td>DETERGENT LINE FILTER + BARBED VNR 6 MM</td> <td>1.000</td> <td>PC</td> </tr> <tr> <td>VL1128A1</td> <td>D6 BARBED CHECK VALVE</td> <td>1.000</td> <td>PC</td> </tr> <tr> <td>VL1166A0</td> <td>BB6-AR6 L FITTING</td> <td>3.000</td> <td>PC</td> </tr> <tr> <td>VL1174C0</td> <td>D1.2 MM CALIBRATED NOZZLE</td> <td>1.000</td> <td>PC</td> </tr> <tr> <td>VL1185A0</td> <td>2 WAYS PLUS WASHING DISTRIBUTOR</td> <td>1.000</td> <td>PC</td> </tr> <tr> <td>VL1190A0</td> <td>PLUS WASHING SYSTEM INLET DISTRIBUTOR</td> <td>1.000</td> <td>PC</td> </tr> <tr> <td>VL1214A0</td> <td>BAYONET - 6mm BARBED NRV VALVE</td> <td>1.000</td> <td>PC</td> </tr> <tr> <td>VL1398A0</td> <td>1/4 M N.O. CIL PRESSURE SWITCH</td> <td>1.000</td> <td>PC</td> </tr> <tr> <td>VM1605A0</td> <td>CLIP TWIST LOCK DIAM. 10,2-12,7 MM</td> <td>3.000</td> <td>PC</td> </tr> <tr> <td>VM2172A0</td> <td>LOCKING CLIP FOR PUMP WITH CIRCUIT</td> <td>4.000</td> <td>PC</td> </tr> </tbody> </table>	Code	Description	Qty	UOM	TB3225B0	TB2820A-TAN K-WASHYNG SYS CONNECTION	1.000	PC	TB3252A0	TB3252A0	1.000	PC	TB3614A0	TB3614A0	1.000	PC	VI1220A1	4,2x12 TCB SELF-TAPPIN G SCREW	1.000	PC	VL1019A0	VIBRATION DETERGENT PUMP	1.000	PC	VL1047A1	D6 PIPE HOLDER - D8 J.G. TERMINAL	1.000	PC	VL1102A1	DETERGENT LINE FILTER + BARBED VNR 6 MM	1.000	PC	VL1128A1	D6 BARBED CHECK VALVE	1.000	PC	VL1166A0	BB6-AR6 L FITTING	3.000	PC	VL1174C0	D1.2 MM CALIBRATED NOZZLE	1.000	PC	VL1185A0	2 WAYS PLUS WASHING DISTRIBUTOR	1.000	PC	VL1190A0	PLUS WASHING SYSTEM INLET DISTRIBUTOR	1.000	PC	VL1214A0	BAYONET - 6mm BARBED NRV VALVE	1.000	PC	VL1398A0	1/4 M N.O. CIL PRESSURE SWITCH	1.000	PC	VM1605A0	CLIP TWIST LOCK DIAM. 10,2-12,7 MM	3.000	PC	VM2172A0	LOCKING CLIP FOR PUMP WITH CIRCUIT	4.000	PC	KVL1182A	ONE 1ROT CLEANING SYSTEM KIT (0311 EXC.)	<table border="1"> <thead> <tr> <th>Code</th> <th>Description</th> <th>Qty</th> <th>UOM</th> </tr> </thead> <tbody> <tr> <td>0H2202A1</td> <td>ONE WASHING WITH STEAM VALVE SUPPORT</td> <td>1.000</td> <td>PC</td> </tr> </tbody> </table>	Code	Description	Qty	UOM	0H2202A1	ONE WASHING WITH STEAM VALVE SUPPORT	1.000	PC
			Code	Description	Qty	UOM																																																																														
TB3225B0	TB2820A-TAN K-WASHYNG SYS CONNECTION	1.000	PC																																																																																	
TB3252A0	TB3252A0	1.000	PC																																																																																	
TB3614A0	TB3614A0	1.000	PC																																																																																	
VI1220A1	4,2x12 TCB SELF-TAPPIN G SCREW	1.000	PC																																																																																	
VL1019A0	VIBRATION DETERGENT PUMP	1.000	PC																																																																																	
VL1047A1	D6 PIPE HOLDER - D8 J.G. TERMINAL	1.000	PC																																																																																	
VL1102A1	DETERGENT LINE FILTER + BARBED VNR 6 MM	1.000	PC																																																																																	
VL1128A1	D6 BARBED CHECK VALVE	1.000	PC																																																																																	
VL1166A0	BB6-AR6 L FITTING	3.000	PC																																																																																	
VL1174C0	D1.2 MM CALIBRATED NOZZLE	1.000	PC																																																																																	
VL1185A0	2 WAYS PLUS WASHING DISTRIBUTOR	1.000	PC																																																																																	
VL1190A0	PLUS WASHING SYSTEM INLET DISTRIBUTOR	1.000	PC																																																																																	
VL1214A0	BAYONET - 6mm BARBED NRV VALVE	1.000	PC																																																																																	
VL1398A0	1/4 M N.O. CIL PRESSURE SWITCH	1.000	PC																																																																																	
VM1605A0	CLIP TWIST LOCK DIAM. 10,2-12,7 MM	3.000	PC																																																																																	
VM2172A0	LOCKING CLIP FOR PUMP WITH CIRCUIT	4.000	PC																																																																																	
Code	Description	Qty	UOM																																																																																	
0H2202A1	ONE WASHING WITH STEAM VALVE SUPPORT	1.000	PC																																																																																	



COMPONENT			SPARE PART																																																																																										
Code	Description	Image	Code	Description	Kit components																																																																																								
VL1019A	VIBRATION DETERGENT PUMP		KVL1182A	ONE 1ROT CLEANING SYSTEM KIT (0311 EXC.)	<table border="1"> <thead> <tr> <th>Code</th> <th>Description</th> <th>Qty</th> <th>UOM</th> </tr> </thead> <tbody> <tr> <td>EL1440A0</td> <td>WATER SELF CLEANING VALVE</td> <td>1.000</td> <td>PC</td> </tr> <tr> <td>GN1526A0</td> <td>INT. D.=6.9 TH=1.8 O-RIN</td> <td>3.000</td> <td>PC</td> </tr> <tr> <td>RC1019A0</td> <td>D=10 ELASTIC CLAMP</td> <td>12.000</td> <td>PC</td> </tr> <tr> <td>RC1242A0</td> <td>D=10 CLOSED CAP</td> <td>2.000</td> <td>PC</td> </tr> <tr> <td>RC1414A1</td> <td>D11.5-12.5 SINGLE EAR HOSE CLAMP</td> <td>1.000</td> <td>PC</td> </tr> <tr> <td>TB2821A0</td> <td>EPDM 6X10 L=40MM PIPE</td> <td>4.000</td> <td>PC</td> </tr> <tr> <td>TB3004A0</td> <td>TB2820A L=550mm EPDM BLACK PIPE</td> <td>1.000</td> <td>PC</td> </tr> <tr> <td>TB3009B0</td> <td>TB3132A-ONE OVEN WASHING INLET</td> <td>1.000</td> <td>PC</td> </tr> <tr> <td>TB3225B0</td> <td>TB2820A-TAN K-WASHYNG SYS CONNECTION</td> <td>1.000</td> <td>PC</td> </tr> <tr> <td>TB3614A0</td> <td>TB3614A0</td> <td>1.000</td> <td>PC</td> </tr> <tr> <td>VI1220A1</td> <td>4,2x12 TCB SELF-TAPPIN G SCREW</td> <td>2.000</td> <td>PC</td> </tr> <tr> <td>VL1019A0</td> <td>VIBRATION DETERGENT PUMP</td> <td></td> <td>1.000</td> <td>PC</td> </tr> <tr> <td>VL1047A1</td> <td>D6 PIPE HOLDER - D8 J.G. TERMINAL</td> <td></td> <td>1.000</td> <td>PC</td> </tr> <tr> <td>VL1054B0</td> <td>ONE WASHING SYS INLET DISTRIBUTOR</td> <td></td> <td>1.000</td> <td>PC</td> </tr> <tr> <td>VL1102A1</td> <td>DETERGENT LINE FILTER + BARBED VNR 6 MM</td> <td></td> <td>1.000</td> <td>PC</td> </tr> <tr> <td>VL1128A1</td> <td>D6 BARBED CHECK VALVE</td> <td></td> <td>1.000</td> <td>PC</td> </tr> <tr> <td>VL1166A0</td> <td>BB6-AR6 L FITTING</td> <td></td> <td>1.000</td> <td>PC</td> </tr> <tr> <td>VL1174C0</td> <td>D1.2 MM CALIBRATED NOZZLE</td> <td></td> <td>1.000</td> <td>PC</td> </tr> <tr> <td>VL1191A0</td> <td>ONE WASHING DISTRIBUTOR OUTLETS KIT</td> <td></td> <td>1.000</td> <td>PC</td> </tr> </tbody> </table>	Code	Description	Qty	UOM	EL1440A0	WATER SELF CLEANING VALVE	1.000	PC	GN1526A0	INT. D.=6.9 TH=1.8 O-RIN	3.000	PC	RC1019A0	D=10 ELASTIC CLAMP	12.000	PC	RC1242A0	D=10 CLOSED CAP	2.000	PC	RC1414A1	D11.5-12.5 SINGLE EAR HOSE CLAMP	1.000	PC	TB2821A0	EPDM 6X10 L=40MM PIPE	4.000	PC	TB3004A0	TB2820A L=550mm EPDM BLACK PIPE	1.000	PC	TB3009B0	TB3132A-ONE OVEN WASHING INLET	1.000	PC	TB3225B0	TB2820A-TAN K-WASHYNG SYS CONNECTION	1.000	PC	TB3614A0	TB3614A0	1.000	PC	VI1220A1	4,2x12 TCB SELF-TAPPIN G SCREW	2.000	PC	VL1019A0	VIBRATION DETERGENT PUMP		1.000	PC	VL1047A1	D6 PIPE HOLDER - D8 J.G. TERMINAL		1.000	PC	VL1054B0	ONE WASHING SYS INLET DISTRIBUTOR		1.000	PC	VL1102A1	DETERGENT LINE FILTER + BARBED VNR 6 MM		1.000	PC	VL1128A1	D6 BARBED CHECK VALVE		1.000	PC	VL1166A0	BB6-AR6 L FITTING		1.000	PC	VL1174C0	D1.2 MM CALIBRATED NOZZLE		1.000	PC	VL1191A0	ONE WASHING DISTRIBUTOR OUTLETS KIT		1.000	PC
Code	Description	Qty	UOM																																																																																										
EL1440A0	WATER SELF CLEANING VALVE	1.000	PC																																																																																										
GN1526A0	INT. D.=6.9 TH=1.8 O-RIN	3.000	PC																																																																																										
RC1019A0	D=10 ELASTIC CLAMP	12.000	PC																																																																																										
RC1242A0	D=10 CLOSED CAP	2.000	PC																																																																																										
RC1414A1	D11.5-12.5 SINGLE EAR HOSE CLAMP	1.000	PC																																																																																										
TB2821A0	EPDM 6X10 L=40MM PIPE	4.000	PC																																																																																										
TB3004A0	TB2820A L=550mm EPDM BLACK PIPE	1.000	PC																																																																																										
TB3009B0	TB3132A-ONE OVEN WASHING INLET	1.000	PC																																																																																										
TB3225B0	TB2820A-TAN K-WASHYNG SYS CONNECTION	1.000	PC																																																																																										
TB3614A0	TB3614A0	1.000	PC																																																																																										
VI1220A1	4,2x12 TCB SELF-TAPPIN G SCREW	2.000	PC																																																																																										
VL1019A0	VIBRATION DETERGENT PUMP		1.000	PC																																																																																									
VL1047A1	D6 PIPE HOLDER - D8 J.G. TERMINAL		1.000	PC																																																																																									
VL1054B0	ONE WASHING SYS INLET DISTRIBUTOR		1.000	PC																																																																																									
VL1102A1	DETERGENT LINE FILTER + BARBED VNR 6 MM		1.000	PC																																																																																									
VL1128A1	D6 BARBED CHECK VALVE		1.000	PC																																																																																									
VL1166A0	BB6-AR6 L FITTING		1.000	PC																																																																																									
VL1174C0	D1.2 MM CALIBRATED NOZZLE		1.000	PC																																																																																									
VL1191A0	ONE WASHING DISTRIBUTOR OUTLETS KIT		1.000	PC																																																																																									



COMPONENT			SPARE PART																																																			
Code	Description	Image	Code	Description	Kit components																																																	
VL1019A	VIBRATION DETERGENT PUMP		KVL1182A	ONE 1ROT CLEANING SYSTEM KIT (0311 EXC.)	<table border="1"> <thead> <tr> <th>Code</th> <th>Description</th> <th>Qty</th> <th>UOM</th> </tr> </thead> <tbody> <tr> <td>VL1214A0</td> <td>BAYONET - 6mm BARBED NRV VALVE</td> <td>1.000</td> <td>PC</td> </tr> <tr> <td>VM2172A0</td> <td>LOCKING CLIP FOR PUMP WITH CIRCUIT</td> <td>2.000</td> <td>PC</td> </tr> </tbody> </table>	Code	Description	Qty	UOM	VL1214A0	BAYONET - 6mm BARBED NRV VALVE	1.000	PC	VM2172A0	LOCKING CLIP FOR PUMP WITH CIRCUIT	2.000	PC																																					
			Code	Description	Qty	UOM																																																
			VL1214A0	BAYONET - 6mm BARBED NRV VALVE	1.000	PC																																																
VM2172A0	LOCKING CLIP FOR PUMP WITH CIRCUIT	2.000	PC																																																			
KVL0684A	>12/2019 2-3ROTOR ARM PLUS WASH PUMP KIT	<table border="1"> <thead> <tr> <th>Code</th> <th>Description</th> <th>Qty</th> <th>UOM</th> </tr> </thead> <tbody> <tr> <td>GN1526A0</td> <td>INT. D.=6.9 TH=1.8 O-RIN</td> <td>3.000</td> <td>PC</td> </tr> <tr> <td>RC1019A0</td> <td>D=10 ELASTIC CLAMP</td> <td>4.000</td> <td>PC</td> </tr> <tr> <td>RC1130A0</td> <td>130x2.6 CLAM</td> <td>1.000</td> <td>PC</td> </tr> <tr> <td>RC1131A0</td> <td>200x2.6 BLACK CLAMP</td> <td>3.000</td> <td>PC</td> </tr> <tr> <td>RC1242A0</td> <td>D=10 CLOSED CAP</td> <td>2.000</td> <td>PC</td> </tr> <tr> <td>TB2821A0</td> <td>EPDM 6X10 L=40MM PIPE</td> <td>3.000</td> <td>PC</td> </tr> <tr> <td>VL1019A0</td> <td>VIBRATION DETERGENT PUMP</td> <td>1.000</td> <td>PC</td> </tr> <tr> <td>VL1128A1</td> <td>D6 BARBED CHECK VALVE</td> <td>1.000</td> <td>PC</td> </tr> <tr> <td>VL1174C0</td> <td>D1.2 MM CALIBRATED NOZZLE</td> <td>1.000</td> <td>PC</td> </tr> <tr> <td>VL1186A0</td> <td>3 WAYS PLUS WASHING DISTRIBUTOR</td> <td>1.000</td> <td>PC</td> </tr> <tr> <td>VL1190A0</td> <td>PLUS WASHING SYSTEM INLET DISTRIBUTOR</td> <td>1.000</td> <td>PC</td> </tr> <tr> <td>VM2172A0</td> <td>LOCKING CLIP FOR PUMP WITH CIRCUIT</td> <td>1.000</td> <td>PC</td> </tr> </tbody> </table>	Code	Description	Qty	UOM	GN1526A0	INT. D.=6.9 TH=1.8 O-RIN	3.000	PC	RC1019A0	D=10 ELASTIC CLAMP	4.000	PC	RC1130A0	130x2.6 CLAM	1.000	PC	RC1131A0	200x2.6 BLACK CLAMP	3.000	PC	RC1242A0	D=10 CLOSED CAP	2.000	PC	TB2821A0	EPDM 6X10 L=40MM PIPE	3.000	PC	VL1019A0	VIBRATION DETERGENT PUMP	1.000	PC	VL1128A1	D6 BARBED CHECK VALVE	1.000	PC	VL1174C0	D1.2 MM CALIBRATED NOZZLE	1.000	PC	VL1186A0	3 WAYS PLUS WASHING DISTRIBUTOR	1.000	PC	VL1190A0	PLUS WASHING SYSTEM INLET DISTRIBUTOR	1.000	PC	VM2172A0	LOCKING CLIP FOR PUMP WITH CIRCUIT	1.000	PC
Code	Description	Qty	UOM																																																			
GN1526A0	INT. D.=6.9 TH=1.8 O-RIN	3.000	PC																																																			
RC1019A0	D=10 ELASTIC CLAMP	4.000	PC																																																			
RC1130A0	130x2.6 CLAM	1.000	PC																																																			
RC1131A0	200x2.6 BLACK CLAMP	3.000	PC																																																			
RC1242A0	D=10 CLOSED CAP	2.000	PC																																																			
TB2821A0	EPDM 6X10 L=40MM PIPE	3.000	PC																																																			
VL1019A0	VIBRATION DETERGENT PUMP	1.000	PC																																																			
VL1128A1	D6 BARBED CHECK VALVE	1.000	PC																																																			
VL1174C0	D1.2 MM CALIBRATED NOZZLE	1.000	PC																																																			
VL1186A0	3 WAYS PLUS WASHING DISTRIBUTOR	1.000	PC																																																			
VL1190A0	PLUS WASHING SYSTEM INLET DISTRIBUTOR	1.000	PC																																																			
VM2172A0	LOCKING CLIP FOR PUMP WITH CIRCUIT	1.000	PC																																																			
KVL0683A	>12/2019 1 ROTOR ARM PLUS WASH PUMP KIT	<table border="1"> <thead> <tr> <th>Code</th> <th>Description</th> <th>Qty</th> <th>UOM</th> </tr> </thead> <tbody> <tr> <td>GN1526A0</td> <td>INT. D.=6.9 TH=1.8 O-RIN</td> <td>2.000</td> <td>PC</td> </tr> <tr> <td>RC1019A0</td> <td>D=10 ELASTIC CLAMP</td> <td>4.000</td> <td>PC</td> </tr> <tr> <td>RC1130A0</td> <td>130x2.6 CLAM</td> <td>1.000</td> <td>PC</td> </tr> <tr> <td>RC1131A0</td> <td>200x2.6 BLACK CLAMP</td> <td>2.000</td> <td>PC</td> </tr> <tr> <td>RC1242A0</td> <td>D=10 CLOSED CAP</td> <td>2.000</td> <td>PC</td> </tr> <tr> <td>TB2821A0</td> <td>EPDM 6X10 L=40MM PIPE</td> <td>3.000</td> <td>PC</td> </tr> <tr> <td>VL1019A0</td> <td>VIBRATION DETERGENT PUMP</td> <td>1.000</td> <td>PC</td> </tr> <tr> <td>VL1128A1</td> <td>D6 BARBED CHECK VALVE</td> <td>1.000</td> <td>PC</td> </tr> </tbody> </table>	Code	Description	Qty	UOM	GN1526A0	INT. D.=6.9 TH=1.8 O-RIN	2.000	PC	RC1019A0	D=10 ELASTIC CLAMP	4.000	PC	RC1130A0	130x2.6 CLAM	1.000	PC	RC1131A0	200x2.6 BLACK CLAMP	2.000	PC	RC1242A0	D=10 CLOSED CAP	2.000	PC	TB2821A0	EPDM 6X10 L=40MM PIPE	3.000	PC	VL1019A0	VIBRATION DETERGENT PUMP	1.000	PC	VL1128A1	D6 BARBED CHECK VALVE	1.000	PC																
Code	Description	Qty	UOM																																																			
GN1526A0	INT. D.=6.9 TH=1.8 O-RIN	2.000	PC																																																			
RC1019A0	D=10 ELASTIC CLAMP	4.000	PC																																																			
RC1130A0	130x2.6 CLAM	1.000	PC																																																			
RC1131A0	200x2.6 BLACK CLAMP	2.000	PC																																																			
RC1242A0	D=10 CLOSED CAP	2.000	PC																																																			
TB2821A0	EPDM 6X10 L=40MM PIPE	3.000	PC																																																			
VL1019A0	VIBRATION DETERGENT PUMP	1.000	PC																																																			
VL1128A1	D6 BARBED CHECK VALVE	1.000	PC																																																			





COMPONENT			SPARE PART																																											
Code	Description	Image	Code	Description	Kit components																																									
VL1019A	VIBRATION DETERGENT PUMP		KVL0683A	>12/2019 1 ROTOR ARM PLUS WASH PUMP KIT	<table border="1"> <thead> <tr> <th>Code</th> <th>Description</th> <th>Qty</th> <th>UOM</th> </tr> </thead> <tbody> <tr> <td>VL1174C0</td> <td>D1.2 MM CALIBRATED NOZZLE</td> <td>1.000</td> <td>PC</td> </tr> <tr> <td>VL1185A0</td> <td>2 WAYS PLUS WASHING DISTRIBUTOR</td> <td>1.000</td> <td>PC</td> </tr> <tr> <td>VL1190A0</td> <td>PLUS WASHING SYSTEM INLET DISTRIBUTOR</td> <td>1.000</td> <td>PC</td> </tr> <tr> <td>VM2172A0</td> <td>LOCKING CLIP FOR PUMP WITH CIRCUIT</td> <td>1.000</td> <td>PC</td> </tr> </tbody> </table>	Code	Description	Qty	UOM	VL1174C0	D1.2 MM CALIBRATED NOZZLE	1.000	PC	VL1185A0	2 WAYS PLUS WASHING DISTRIBUTOR	1.000	PC	VL1190A0	PLUS WASHING SYSTEM INLET DISTRIBUTOR	1.000	PC	VM2172A0	LOCKING CLIP FOR PUMP WITH CIRCUIT	1.000	PC																					
			Code	Description	Qty	UOM																																								
			VL1174C0	D1.2 MM CALIBRATED NOZZLE	1.000	PC																																								
VL1185A0	2 WAYS PLUS WASHING DISTRIBUTOR	1.000	PC																																											
VL1190A0	PLUS WASHING SYSTEM INLET DISTRIBUTOR	1.000	PC																																											
VM2172A0	LOCKING CLIP FOR PUMP WITH CIRCUIT	1.000	PC																																											
KVL0682A	>12/2019 ONE/HOODS WASHING SYST PUMP KIT	<table border="1"> <thead> <tr> <th>Code</th> <th>Description</th> <th>Qty</th> <th>UOM</th> </tr> </thead> <tbody> <tr> <td>GN1526A0</td> <td>INT. D.=6.9 TH=1.8 O-RING</td> <td>1.000</td> <td>PC</td> </tr> <tr> <td>RC1019A0</td> <td>D=10 ELASTIC CLAMP</td> <td>6.000</td> <td>PC</td> </tr> <tr> <td>RC1242A0</td> <td>D=10 CLOSED CAP</td> <td>2.000</td> <td>PC</td> </tr> <tr> <td>TB2821A0</td> <td>EPDM 6X10 L=40MM PIPE</td> <td>3.000</td> <td>PC</td> </tr> <tr> <td>VL1019A0</td> <td>VIBRATION DETERGENT PUMP</td> <td>1.000</td> <td>PC</td> </tr> <tr> <td>VL1054B0</td> <td>ONE WASHING SYS INLET DISTRIBUTOR</td> <td>1.000</td> <td>PC</td> </tr> <tr> <td>VL1128A1</td> <td>D6 BARBED CHECK VALVE</td> <td>1.000</td> <td>PC</td> </tr> <tr> <td>VL1174C0</td> <td>D1.2 MM CALIBRATED NOZZLE</td> <td>1.000</td> <td>PC</td> </tr> <tr> <td>VL1191A0</td> <td>ONE WASHING DISTRIBUTOR OUTLETS KIT</td> <td>1.000</td> <td>PC</td> </tr> <tr> <td>VM2172A0</td> <td>LOCKING CLIP FOR PUMP WITH CIRCUIT</td> <td>1.000</td> <td>PC</td> </tr> </tbody> </table>	Code	Description	Qty	UOM	GN1526A0	INT. D.=6.9 TH=1.8 O-RING	1.000	PC	RC1019A0	D=10 ELASTIC CLAMP	6.000	PC	RC1242A0	D=10 CLOSED CAP	2.000	PC	TB2821A0	EPDM 6X10 L=40MM PIPE	3.000	PC	VL1019A0	VIBRATION DETERGENT PUMP	1.000	PC	VL1054B0	ONE WASHING SYS INLET DISTRIBUTOR	1.000	PC	VL1128A1	D6 BARBED CHECK VALVE	1.000	PC	VL1174C0	D1.2 MM CALIBRATED NOZZLE	1.000	PC	VL1191A0	ONE WASHING DISTRIBUTOR OUTLETS KIT	1.000	PC	VM2172A0	LOCKING CLIP FOR PUMP WITH CIRCUIT	1.000	PC
Code	Description	Qty	UOM																																											
GN1526A0	INT. D.=6.9 TH=1.8 O-RING	1.000	PC																																											
RC1019A0	D=10 ELASTIC CLAMP	6.000	PC																																											
RC1242A0	D=10 CLOSED CAP	2.000	PC																																											
TB2821A0	EPDM 6X10 L=40MM PIPE	3.000	PC																																											
VL1019A0	VIBRATION DETERGENT PUMP	1.000	PC																																											
VL1054B0	ONE WASHING SYS INLET DISTRIBUTOR	1.000	PC																																											
VL1128A1	D6 BARBED CHECK VALVE	1.000	PC																																											
VL1174C0	D1.2 MM CALIBRATED NOZZLE	1.000	PC																																											
VL1191A0	ONE WASHING DISTRIBUTOR OUTLETS KIT	1.000	PC																																											
VM2172A0	LOCKING CLIP FOR PUMP WITH CIRCUIT	1.000	PC																																											
KVL0001A	LM TOP CLEANING SYSTEM KIT	<table border="1"> <thead> <tr> <th>Code</th> <th>Description</th> <th>Qty</th> <th>UOM</th> </tr> </thead> <tbody> <tr> <td>0H1226B0</td> <td>LineMissTop WASHING SYTEM CIRCUIT COVE</td> <td>1.000</td> <td>PC</td> </tr> <tr> <td>EL1436B0</td> <td>JG D8-BARBED D6 NRV WATER SOLENOID</td> <td>1.000</td> <td>PC</td> </tr> </tbody> </table>	Code	Description	Qty	UOM	0H1226B0	LineMissTop WASHING SYTEM CIRCUIT COVE	1.000	PC	EL1436B0	JG D8-BARBED D6 NRV WATER SOLENOID	1.000	PC																																
Code	Description	Qty	UOM																																											
0H1226B0	LineMissTop WASHING SYTEM CIRCUIT COVE	1.000	PC																																											
EL1436B0	JG D8-BARBED D6 NRV WATER SOLENOID	1.000	PC																																											



COMPONENT			SPARE PART																																																																														
Code	Description	Image	Code	Description	Kit components																																																																												
VL1019A	VIBRATION DETERGENT PUMP		KVL0001A	LM TOP CLEANING SYSTEM KIT	<table border="1"> <thead> <tr> <th>Code</th> <th>Description</th> <th>Qty</th> <th>UOM</th> </tr> </thead> <tbody> <tr> <td>GN1312A0</td> <td>RUBBER CABLE-PASSI NG DE=26 DI=15 SP=10</td> <td>1.000</td> <td>PC</td> </tr> <tr> <td>GN1526A0</td> <td>INT. D.=6.9 TH=1.8 O-RIN</td> <td>1.000</td> <td>PC</td> </tr> <tr> <td>RC1008A0</td> <td>D9 ELASTIC CLIP</td> <td>1.000</td> <td>PC</td> </tr> <tr> <td>RC1019A0</td> <td>D=10 ELASTIC CLAMP</td> <td>10.000</td> <td>PC</td> </tr> <tr> <td>RC1242A0</td> <td>D=10 CLOSED CAP</td> <td>2.000</td> <td>PC</td> </tr> <tr> <td>TB1114A1</td> <td>TB2820A-LM TOP DETERGENT PIPE COIL ROTOR</td> <td>1.000</td> <td>PC</td> </tr> <tr> <td>TB1116A0</td> <td>TB2343A-DETE RGENT HOLD DOWN WEIGHT PIPE</td> <td>1.000</td> <td>PC</td> </tr> <tr> <td>TB2821A0</td> <td>EPDM 6X10 L=40MM PIPE</td> <td>4.000</td> <td>PC</td> </tr> <tr> <td>VI1220A1</td> <td>4,2x12 TCB SELF-TAPPIN G SCREW</td> <td>1.000</td> <td>PC</td> </tr> <tr> <td>VL1019A0</td> <td>VIBRATION DETERGENT PUMP</td> <td>1.000</td> <td>PC</td> </tr> <tr> <td>VL1047A1</td> <td>D6 PIPE HOLDER - D6 J.G. TERMINAL</td> <td>1.000</td> <td>PC</td> </tr> <tr> <td>VL1053B0</td> <td>ONE WASHING SYS EXT DISTRIBUTOR</td> <td>1.000</td> <td>PC</td> </tr> <tr> <td>VL1054B0</td> <td>ONE WASHING SYS INLET DISTRIBUTOR</td> <td>1.000</td> <td>PC</td> </tr> <tr> <td>VL1061A0</td> <td>HOLD DOWN WEIGHT+NET FILTER+NON- RET. V.</td> <td>1.000</td> <td>PC</td> </tr> <tr> <td>VL1090A0</td> <td>1LT TANK UNOX.DET&RI NSE CAP</td> <td>1.000</td> <td>PC</td> </tr> <tr> <td>VL1128A1</td> <td>D6 BARBED CHECK VALVE</td> <td>1.000</td> <td>PC</td> </tr> <tr> <td>VM1066A0</td> <td>SADDLE CLIP FOR CABLES PASSING</td> <td>3.000</td> <td>PC</td> </tr> <tr> <td>VM1088A0</td> <td>NYLON CLICK CLAMP D7.9-D9.2</td> <td>1.000</td> <td>PC</td> </tr> </tbody> </table>	Code	Description	Qty	UOM	GN1312A0	RUBBER CABLE-PASSI NG DE=26 DI=15 SP=10	1.000	PC	GN1526A0	INT. D.=6.9 TH=1.8 O-RIN	1.000	PC	RC1008A0	D9 ELASTIC CLIP	1.000	PC	RC1019A0	D=10 ELASTIC CLAMP	10.000	PC	RC1242A0	D=10 CLOSED CAP	2.000	PC	TB1114A1	TB2820A-LM TOP DETERGENT PIPE COIL ROTOR	1.000	PC	TB1116A0	TB2343A-DETE RGENT HOLD DOWN WEIGHT PIPE	1.000	PC	TB2821A0	EPDM 6X10 L=40MM PIPE	4.000	PC	VI1220A1	4,2x12 TCB SELF-TAPPIN G SCREW	1.000	PC	VL1019A0	VIBRATION DETERGENT PUMP	1.000	PC	VL1047A1	D6 PIPE HOLDER - D6 J.G. TERMINAL	1.000	PC	VL1053B0	ONE WASHING SYS EXT DISTRIBUTOR	1.000	PC	VL1054B0	ONE WASHING SYS INLET DISTRIBUTOR	1.000	PC	VL1061A0	HOLD DOWN WEIGHT+NET FILTER+NON- RET. V.	1.000	PC	VL1090A0	1LT TANK UNOX.DET&RI NSE CAP	1.000	PC	VL1128A1	D6 BARBED CHECK VALVE	1.000	PC	VM1066A0	SADDLE CLIP FOR CABLES PASSING	3.000	PC	VM1088A0	NYLON CLICK CLAMP D7.9-D9.2	1.000	PC
Code	Description	Qty	UOM																																																																														
GN1312A0	RUBBER CABLE-PASSI NG DE=26 DI=15 SP=10	1.000	PC																																																																														
GN1526A0	INT. D.=6.9 TH=1.8 O-RIN	1.000	PC																																																																														
RC1008A0	D9 ELASTIC CLIP	1.000	PC																																																																														
RC1019A0	D=10 ELASTIC CLAMP	10.000	PC																																																																														
RC1242A0	D=10 CLOSED CAP	2.000	PC																																																																														
TB1114A1	TB2820A-LM TOP DETERGENT PIPE COIL ROTOR	1.000	PC																																																																														
TB1116A0	TB2343A-DETE RGENT HOLD DOWN WEIGHT PIPE	1.000	PC																																																																														
TB2821A0	EPDM 6X10 L=40MM PIPE	4.000	PC																																																																														
VI1220A1	4,2x12 TCB SELF-TAPPIN G SCREW	1.000	PC																																																																														
VL1019A0	VIBRATION DETERGENT PUMP	1.000	PC																																																																														
VL1047A1	D6 PIPE HOLDER - D6 J.G. TERMINAL	1.000	PC																																																																														
VL1053B0	ONE WASHING SYS EXT DISTRIBUTOR	1.000	PC																																																																														
VL1054B0	ONE WASHING SYS INLET DISTRIBUTOR	1.000	PC																																																																														
VL1061A0	HOLD DOWN WEIGHT+NET FILTER+NON- RET. V.	1.000	PC																																																																														
VL1090A0	1LT TANK UNOX.DET&RI NSE CAP	1.000	PC																																																																														
VL1128A1	D6 BARBED CHECK VALVE	1.000	PC																																																																														
VM1066A0	SADDLE CLIP FOR CABLES PASSING	3.000	PC																																																																														
VM1088A0	NYLON CLICK CLAMP D7.9-D9.2	1.000	PC																																																																														



COMPONENT			SPARE PART																																										
Code	Description	Image	Code	Description	Kit components																																								
VL1019A	VIBRATION DETERGENT PUMP		KVL0001A	LM TOP CLEANING SYSTEM KIT	<table border="1"> <thead> <tr> <th>Code</th> <th>Description</th> <th>Qty</th> <th>UOM</th> </tr> </thead> <tbody> <tr> <td>VM1605A0</td> <td>CLIP TWIST LOCK DIAM. 10,2-12,7 MM</td> <td>1.000</td> <td>PC</td> </tr> <tr> <td>VM2172A0</td> <td>LOCKING CLIP FOR PUMP WITH CIRCUIT</td> <td>1.000</td> <td>PC</td> </tr> </tbody> </table>	Code	Description	Qty	UOM	VM1605A0	CLIP TWIST LOCK DIAM. 10,2-12,7 MM	1.000	PC	VM2172A0	LOCKING CLIP FOR PUMP WITH CIRCUIT	1.000	PC																												
Code	Description	Qty	UOM																																										
VM1605A0	CLIP TWIST LOCK DIAM. 10,2-12,7 MM	1.000	PC																																										
VM2172A0	LOCKING CLIP FOR PUMP WITH CIRCUIT	1.000	PC																																										
VL1128A	D6 BARBED CHECK VALVE		KVL1128A	D6 VNR BARBED VALVE KIT	<table border="1"> <thead> <tr> <th>Code</th> <th>Description</th> <th>Qty</th> <th>UOM</th> </tr> </thead> <tbody> <tr> <td>RC1019A0</td> <td>D=10 ELASTIC CLAMP</td> <td>4.000</td> <td>PC</td> </tr> <tr> <td>TB2820A0</td> <td>6X10 EPDM PIPE FOR WASHING SYSTEM</td> <td>0.080</td> <td>M</td> </tr> <tr> <td>VL1128A1</td> <td>D6 BARBED CHECK VALVE</td> <td>1.000</td> <td>PC</td> </tr> </tbody> </table>	Code	Description	Qty	UOM	RC1019A0	D=10 ELASTIC CLAMP	4.000	PC	TB2820A0	6X10 EPDM PIPE FOR WASHING SYSTEM	0.080	M	VL1128A1	D6 BARBED CHECK VALVE	1.000	PC																								
Code	Description	Qty	UOM																																										
RC1019A0	D=10 ELASTIC CLAMP	4.000	PC																																										
TB2820A0	6X10 EPDM PIPE FOR WASHING SYSTEM	0.080	M																																										
VL1128A1	D6 BARBED CHECK VALVE	1.000	PC																																										
VL1174C	D1.2 MM CALIBRATED NOZZL		VL1174C0	D1.2 MM CALIBRATED NOZZL																																									
VL1185A	2 WAYS PLUS WASHING DISTRIBUTOR		KVL1213A	US PLUS COMPACT WASHING SYSTEM KIT	<table border="1"> <thead> <tr> <th>Code</th> <th>Description</th> <th>Qty</th> <th>UOM</th> </tr> </thead> <tbody> <tr> <td>0H2428A2</td> <td>XECC PLUS WASHING CIRCUIT PLAT</td> <td>1.000</td> <td>PC</td> </tr> <tr> <td>EL1450A0</td> <td>US SELF-CLEANIN G WATER SOLENOID</td> <td>3.000</td> <td>PC</td> </tr> <tr> <td>GN1311A0</td> <td>RUBBER CABLE-PASSI NG D=25 Di=12 Th=6,5</td> <td>1.000</td> <td>PC</td> </tr> <tr> <td>GN1526A0</td> <td>INT. D.=6.9 TH=1.8 O-RIN</td> <td>7.000</td> <td>PC</td> </tr> <tr> <td>RC1018A0</td> <td>ZINC PLATED D12 ELASTIC CLAMP</td> <td>5.000</td> <td>PC</td> </tr> <tr> <td>RC1019A0</td> <td>D=10 ELASTIC CLAMP</td> <td>14.000</td> <td>PC</td> </tr> <tr> <td>RC1130A0</td> <td>130x2,6 CLAM</td> <td>1.000</td> <td>PC</td> </tr> <tr> <td>RC1131A0</td> <td>200x2,6 BLACK CLAMP</td> <td>1.000</td> <td>PC</td> </tr> <tr> <td>RC1242A0</td> <td>D=10 CLOSED CAP</td> <td>2.000</td> <td>PC</td> </tr> </tbody> </table>	Code	Description	Qty	UOM	0H2428A2	XECC PLUS WASHING CIRCUIT PLAT	1.000	PC	EL1450A0	US SELF-CLEANIN G WATER SOLENOID	3.000	PC	GN1311A0	RUBBER CABLE-PASSI NG D=25 Di=12 Th=6,5	1.000	PC	GN1526A0	INT. D.=6.9 TH=1.8 O-RIN	7.000	PC	RC1018A0	ZINC PLATED D12 ELASTIC CLAMP	5.000	PC	RC1019A0	D=10 ELASTIC CLAMP	14.000	PC	RC1130A0	130x2,6 CLAM	1.000	PC	RC1131A0	200x2,6 BLACK CLAMP	1.000	PC	RC1242A0	D=10 CLOSED CAP	2.000	PC
Code	Description	Qty	UOM																																										
0H2428A2	XECC PLUS WASHING CIRCUIT PLAT	1.000	PC																																										
EL1450A0	US SELF-CLEANIN G WATER SOLENOID	3.000	PC																																										
GN1311A0	RUBBER CABLE-PASSI NG D=25 Di=12 Th=6,5	1.000	PC																																										
GN1526A0	INT. D.=6.9 TH=1.8 O-RIN	7.000	PC																																										
RC1018A0	ZINC PLATED D12 ELASTIC CLAMP	5.000	PC																																										
RC1019A0	D=10 ELASTIC CLAMP	14.000	PC																																										
RC1130A0	130x2,6 CLAM	1.000	PC																																										
RC1131A0	200x2,6 BLACK CLAMP	1.000	PC																																										
RC1242A0	D=10 CLOSED CAP	2.000	PC																																										



COMPONENT			SPARE PART																																																																														
Code	Description	Image	Code	Description	Kit components																																																																												
VL1185A	2 WAYS PLUS WASHING DISTRIBUTOR		KVL1213A	US PLUS COMPACT WASHING SYSTEM KIT	<table border="1"> <thead> <tr> <th>Code</th> <th>Description</th> <th>Qty</th> <th>UOM</th> </tr> </thead> <tbody> <tr> <td>RC1356A0</td> <td>"STRAIGHT THREADED FEMALE END 8x1/4" BS</td> <td>1.000</td> <td>PC</td> </tr> <tr> <td>RC1414A1</td> <td>D11.5-12.5 SINGLE EAR HOSE CLAMP</td> <td>4.000</td> <td>PC</td> </tr> <tr> <td>TB2821A0</td> <td>EPDM 6X10 L=40MM PIPE</td> <td>6.000</td> <td>PC</td> </tr> <tr> <td>TB3004A0</td> <td>TB2820A L=550mm EPDM BLACK PIPE</td> <td>2.000</td> <td>PC</td> </tr> <tr> <td>TB3005B0</td> <td>TB3132A L=550mm EPDM WHITE-BLUE PIPE</td> <td>1.000</td> <td>PC</td> </tr> <tr> <td>TB3252A0</td> <td>TB3252A0</td> <td>1.000</td> <td>PC</td> </tr> <tr> <td>TB3469A0</td> <td></td> <td>1.000</td> <td>PC</td> </tr> <tr> <td>VI1220A1</td> <td>4,2x12 TCB SELF-TAPPIN G SCREW</td> <td>3.000</td> <td>PC</td> </tr> <tr> <td>VL1019A0</td> <td>VIBRATION DETERGENT PUMP</td> <td>1.000</td> <td>PC</td> </tr> <tr> <td>VL1047A1</td> <td>D6 PIPE HOLDER - D8 J.G. TERMINAL</td> <td>1.000</td> <td>PC</td> </tr> <tr> <td>VL1054B0</td> <td>ONE WASHING SYS INLET DISTRIBUTOR</td> <td>1.000</td> <td>PC</td> </tr> <tr> <td>VL1065A1</td> <td>1/4 MALE N.O. PRESSURE SWITCH</td> <td>1.000</td> <td>PC</td> </tr> <tr> <td>VL1102A1</td> <td>DETERGENT LINE FILTER + BARBED VNR 6 MM</td> <td>1.000</td> <td>PC</td> </tr> <tr> <td>VL1127A1</td> <td>6mm BARBED T-SHAPED FITTING</td> <td>1.000</td> <td>PC</td> </tr> <tr> <td>VL1128A1</td> <td>D6 BARBED CHECK VALVE</td> <td>2.000</td> <td>PC</td> </tr> <tr> <td>VL1165A0</td> <td>BAM-BB6 STRAIGHT FITTING</td> <td>1.000</td> <td>PC</td> </tr> <tr> <td>VL1166A0</td> <td>BB6-AR6 L FITTING</td> <td>3.000</td> <td>PC</td> </tr> <tr> <td>VL1174C0</td> <td>D1.2 MM CALIBRATED NOZZLE</td> <td>1.000</td> <td>PC</td> </tr> </tbody> </table>	Code	Description	Qty	UOM	RC1356A0	"STRAIGHT THREADED FEMALE END 8x1/4" BS	1.000	PC	RC1414A1	D11.5-12.5 SINGLE EAR HOSE CLAMP	4.000	PC	TB2821A0	EPDM 6X10 L=40MM PIPE	6.000	PC	TB3004A0	TB2820A L=550mm EPDM BLACK PIPE	2.000	PC	TB3005B0	TB3132A L=550mm EPDM WHITE-BLUE PIPE	1.000	PC	TB3252A0	TB3252A0	1.000	PC	TB3469A0		1.000	PC	VI1220A1	4,2x12 TCB SELF-TAPPIN G SCREW	3.000	PC	VL1019A0	VIBRATION DETERGENT PUMP	1.000	PC	VL1047A1	D6 PIPE HOLDER - D8 J.G. TERMINAL	1.000	PC	VL1054B0	ONE WASHING SYS INLET DISTRIBUTOR	1.000	PC	VL1065A1	1/4 MALE N.O. PRESSURE SWITCH	1.000	PC	VL1102A1	DETERGENT LINE FILTER + BARBED VNR 6 MM	1.000	PC	VL1127A1	6mm BARBED T-SHAPED FITTING	1.000	PC	VL1128A1	D6 BARBED CHECK VALVE	2.000	PC	VL1165A0	BAM-BB6 STRAIGHT FITTING	1.000	PC	VL1166A0	BB6-AR6 L FITTING	3.000	PC	VL1174C0	D1.2 MM CALIBRATED NOZZLE	1.000	PC
					Code	Description	Qty	UOM																																																																									
					RC1356A0	"STRAIGHT THREADED FEMALE END 8x1/4" BS	1.000	PC																																																																									
					RC1414A1	D11.5-12.5 SINGLE EAR HOSE CLAMP	4.000	PC																																																																									
					TB2821A0	EPDM 6X10 L=40MM PIPE	6.000	PC																																																																									
					TB3004A0	TB2820A L=550mm EPDM BLACK PIPE	2.000	PC																																																																									
					TB3005B0	TB3132A L=550mm EPDM WHITE-BLUE PIPE	1.000	PC																																																																									
					TB3252A0	TB3252A0	1.000	PC																																																																									
					TB3469A0		1.000	PC																																																																									
					VI1220A1	4,2x12 TCB SELF-TAPPIN G SCREW	3.000	PC																																																																									
					VL1019A0	VIBRATION DETERGENT PUMP	1.000	PC																																																																									
					VL1047A1	D6 PIPE HOLDER - D8 J.G. TERMINAL	1.000	PC																																																																									
					VL1054B0	ONE WASHING SYS INLET DISTRIBUTOR	1.000	PC																																																																									
					VL1065A1	1/4 MALE N.O. PRESSURE SWITCH	1.000	PC																																																																									
					VL1102A1	DETERGENT LINE FILTER + BARBED VNR 6 MM	1.000	PC																																																																									
					VL1127A1	6mm BARBED T-SHAPED FITTING	1.000	PC																																																																									
					VL1128A1	D6 BARBED CHECK VALVE	2.000	PC																																																																									
					VL1165A0	BAM-BB6 STRAIGHT FITTING	1.000	PC																																																																									
					VL1166A0	BB6-AR6 L FITTING	3.000	PC																																																																									
					VL1174C0	D1.2 MM CALIBRATED NOZZLE	1.000	PC																																																																									



COMPONENT			SPARE PART																																																																											
Code	Description	Image	Code	Description	Kit components																																																																									
VL1185A	2 WAYS PLUS WASHING DISTRIBUTOR		KVL1213A	US PLUS COMPACT WASHING SYSTEM KIT	<table border="1"> <thead> <tr> <th>Code</th> <th>Description</th> <th>Qty</th> <th>UOM</th> </tr> </thead> <tbody> <tr> <td>VL1185A0</td> <td>2 WAYS PLUS WASHING DISTRIBUTOR</td> <td>1.000</td> <td>PC</td> </tr> <tr> <td>VM2172A0</td> <td>LOCKING CLIP FOR PUMP WITH CIRCUIT</td> <td>3.000</td> <td>PC</td> </tr> </tbody> </table>	Code	Description	Qty	UOM	VL1185A0	2 WAYS PLUS WASHING DISTRIBUTOR	1.000	PC	VM2172A0	LOCKING CLIP FOR PUMP WITH CIRCUIT	3.000	PC																																																													
			Code	Description	Qty	UOM																																																																								
VL1185A0	2 WAYS PLUS WASHING DISTRIBUTOR	1.000	PC																																																																											
VM2172A0	LOCKING CLIP FOR PUMP WITH CIRCUIT	3.000	PC																																																																											
KVL1212A	EUR COMPACT PLUS CLEANING SYSTEM KIT	<table border="1"> <thead> <tr> <th>Code</th> <th>Description</th> <th>Qty</th> <th>UOM</th> </tr> </thead> <tbody> <tr> <td>0H2428A2</td> <td>XECC PLUS WASHING CIRCUIT PLAT</td> <td>1.000</td> <td>PC</td> </tr> <tr> <td>EL1440A0</td> <td>WATER SELF CLEANING VALVE</td> <td>3.000</td> <td>PC</td> </tr> <tr> <td>GN1311A0</td> <td>RUBBER CABLE-PASSI NG Dø=25 Di=12 Th=6,5</td> <td>1.000</td> <td>PC</td> </tr> <tr> <td>GN1526A0</td> <td>INT. D.=6.9 TH=1.8 O-RIN</td> <td>7.000</td> <td>PC</td> </tr> <tr> <td>RC1018A0</td> <td>ZINC PLATED D12 ELASTIC CLAMP</td> <td>5.000</td> <td>PC</td> </tr> <tr> <td>RC1019A0</td> <td>D=10 ELASTIC CLAMP</td> <td>14.000</td> <td>PC</td> </tr> <tr> <td>RC1130A0</td> <td>130x2,6 CLAM</td> <td>1.000</td> <td>PC</td> </tr> <tr> <td>RC1131A0</td> <td>200x2,6 BLACK CLAMP</td> <td>1.000</td> <td>PC</td> </tr> <tr> <td>RC1242A0</td> <td>D=10 CLOSED CAP</td> <td>2.000</td> <td>PC</td> </tr> <tr> <td>RC1356A0</td> <td>"STRAIGHT THREADED FEMALE END 8x1/4" BS</td> <td>1.000</td> <td>PC</td> </tr> <tr> <td>RC1414A1</td> <td>D11.5-12.5 SINGLE EAR HOSE CLAMP</td> <td>4.000</td> <td>PC</td> </tr> <tr> <td>TB2821A0</td> <td>EPDM 6X10 L=40MM PIPE</td> <td>6.000</td> <td>PC</td> </tr> <tr> <td>TB3004A0</td> <td>TB2820A L=550mm EPDM BLACK PIPE</td> <td>2.000</td> <td>PC</td> </tr> <tr> <td>TB3005B0</td> <td>TB3132A L=550mm EPDM WHITE-BLUE PIPE</td> <td>1.000</td> <td>PC</td> </tr> <tr> <td>TB3252A0</td> <td>TB3252A0</td> <td>1.000</td> <td>PC</td> </tr> <tr> <td>TB3469A0</td> <td></td> <td>1.000</td> <td>PC</td> </tr> <tr> <td>VH1220A1</td> <td>4,2x12 TCB SELF-TAPPIN G SCREW</td> <td>3.000</td> <td>PC</td> </tr> <tr> <td>VL1019A0</td> <td>VIBRATION DETERGENT PUMP</td> <td>1.000</td> <td>PC</td> </tr> </tbody> </table>	Code	Description	Qty	UOM	0H2428A2	XECC PLUS WASHING CIRCUIT PLAT	1.000	PC	EL1440A0	WATER SELF CLEANING VALVE	3.000	PC	GN1311A0	RUBBER CABLE-PASSI NG Dø=25 Di=12 Th=6,5	1.000	PC	GN1526A0	INT. D.=6.9 TH=1.8 O-RIN	7.000	PC	RC1018A0	ZINC PLATED D12 ELASTIC CLAMP	5.000	PC	RC1019A0	D=10 ELASTIC CLAMP	14.000	PC	RC1130A0	130x2,6 CLAM	1.000	PC	RC1131A0	200x2,6 BLACK CLAMP	1.000	PC	RC1242A0	D=10 CLOSED CAP	2.000	PC	RC1356A0	"STRAIGHT THREADED FEMALE END 8x1/4" BS	1.000	PC	RC1414A1	D11.5-12.5 SINGLE EAR HOSE CLAMP	4.000	PC	TB2821A0	EPDM 6X10 L=40MM PIPE	6.000	PC	TB3004A0	TB2820A L=550mm EPDM BLACK PIPE	2.000	PC	TB3005B0	TB3132A L=550mm EPDM WHITE-BLUE PIPE	1.000	PC	TB3252A0	TB3252A0	1.000	PC	TB3469A0		1.000	PC	VH1220A1	4,2x12 TCB SELF-TAPPIN G SCREW	3.000	PC	VL1019A0	VIBRATION DETERGENT PUMP	1.000	PC
Code	Description	Qty	UOM																																																																											
0H2428A2	XECC PLUS WASHING CIRCUIT PLAT	1.000	PC																																																																											
EL1440A0	WATER SELF CLEANING VALVE	3.000	PC																																																																											
GN1311A0	RUBBER CABLE-PASSI NG Dø=25 Di=12 Th=6,5	1.000	PC																																																																											
GN1526A0	INT. D.=6.9 TH=1.8 O-RIN	7.000	PC																																																																											
RC1018A0	ZINC PLATED D12 ELASTIC CLAMP	5.000	PC																																																																											
RC1019A0	D=10 ELASTIC CLAMP	14.000	PC																																																																											
RC1130A0	130x2,6 CLAM	1.000	PC																																																																											
RC1131A0	200x2,6 BLACK CLAMP	1.000	PC																																																																											
RC1242A0	D=10 CLOSED CAP	2.000	PC																																																																											
RC1356A0	"STRAIGHT THREADED FEMALE END 8x1/4" BS	1.000	PC																																																																											
RC1414A1	D11.5-12.5 SINGLE EAR HOSE CLAMP	4.000	PC																																																																											
TB2821A0	EPDM 6X10 L=40MM PIPE	6.000	PC																																																																											
TB3004A0	TB2820A L=550mm EPDM BLACK PIPE	2.000	PC																																																																											
TB3005B0	TB3132A L=550mm EPDM WHITE-BLUE PIPE	1.000	PC																																																																											
TB3252A0	TB3252A0	1.000	PC																																																																											
TB3469A0		1.000	PC																																																																											
VH1220A1	4,2x12 TCB SELF-TAPPIN G SCREW	3.000	PC																																																																											
VL1019A0	VIBRATION DETERGENT PUMP	1.000	PC																																																																											



COMPONENT			SPARE PART																																																		
Code	Description	Image	Code	Description	Kit components																																																
VL1185A	2 WAYS PLUS WASHING DISTRIBUTOR		KVL1212A	EUR COMPACT PLUS CLEANING SYSTEM KIT	<table border="1"> <thead> <tr> <th>Code</th> <th>Description</th> <th>Qty</th> <th>UOM</th> </tr> </thead> <tbody> <tr> <td>VL1047A1</td> <td>D6 PIPE HOLDER - D8 J.G. TERMINAL</td> <td>1.000</td> <td>PC</td> </tr> <tr> <td>VL1054B0</td> <td>ONE WASHING SYS INLET DISTRIBUTOR</td> <td>1.000</td> <td>PC</td> </tr> <tr> <td>VL1065A1</td> <td>1/4 MALE N.O. PRESSURE SWITCH</td> <td>1.000</td> <td>PC</td> </tr> <tr> <td>VL1102A1</td> <td>DETERGENT LINE FILTER + BARBED VNR 6 MM</td> <td>1.000</td> <td>PC</td> </tr> <tr> <td>VL1127A1</td> <td>6mm BARBED T-SHAPED FITTING</td> <td>1.000</td> <td>PC</td> </tr> <tr> <td>VL1128A1</td> <td>D6 BARBED CHECK VALVE</td> <td>2.000</td> <td>PC</td> </tr> <tr> <td>VL1165A0</td> <td>BAM-BB6 STRAIGHT FITTING</td> <td>1.000</td> <td>PC</td> </tr> <tr> <td>VL1166A0</td> <td>BB6-AR6 L FITTING</td> <td>3.000</td> <td>PC</td> </tr> <tr> <td>VL1174C0</td> <td>D1.2 MM CALIBRATED NOZZLE</td> <td>1.000</td> <td>PC</td> </tr> <tr> <td>VL1185A0</td> <td>2 WAYS PLUS WASHING DISTRIBUTOR</td> <td>1.000</td> <td>PC</td> </tr> <tr> <td>VM2172A0</td> <td>LOCKING CLIP FOR PUMP WITH CIRCUIT</td> <td>3.000</td> <td>PC</td> </tr> </tbody> </table>	Code	Description	Qty	UOM	VL1047A1	D6 PIPE HOLDER - D8 J.G. TERMINAL	1.000	PC	VL1054B0	ONE WASHING SYS INLET DISTRIBUTOR	1.000	PC	VL1065A1	1/4 MALE N.O. PRESSURE SWITCH	1.000	PC	VL1102A1	DETERGENT LINE FILTER + BARBED VNR 6 MM	1.000	PC	VL1127A1	6mm BARBED T-SHAPED FITTING	1.000	PC	VL1128A1	D6 BARBED CHECK VALVE	2.000	PC	VL1165A0	BAM-BB6 STRAIGHT FITTING	1.000	PC	VL1166A0	BB6-AR6 L FITTING	3.000	PC	VL1174C0	D1.2 MM CALIBRATED NOZZLE	1.000	PC	VL1185A0	2 WAYS PLUS WASHING DISTRIBUTOR	1.000	PC	VM2172A0	LOCKING CLIP FOR PUMP WITH CIRCUIT	3.000	PC
			Code	Description	Qty	UOM																																															
VL1047A1	D6 PIPE HOLDER - D8 J.G. TERMINAL	1.000	PC																																																		
VL1054B0	ONE WASHING SYS INLET DISTRIBUTOR	1.000	PC																																																		
VL1065A1	1/4 MALE N.O. PRESSURE SWITCH	1.000	PC																																																		
VL1102A1	DETERGENT LINE FILTER + BARBED VNR 6 MM	1.000	PC																																																		
VL1127A1	6mm BARBED T-SHAPED FITTING	1.000	PC																																																		
VL1128A1	D6 BARBED CHECK VALVE	2.000	PC																																																		
VL1165A0	BAM-BB6 STRAIGHT FITTING	1.000	PC																																																		
VL1166A0	BB6-AR6 L FITTING	3.000	PC																																																		
VL1174C0	D1.2 MM CALIBRATED NOZZLE	1.000	PC																																																		
VL1185A0	2 WAYS PLUS WASHING DISTRIBUTOR	1.000	PC																																																		
VM2172A0	LOCKING CLIP FOR PUMP WITH CIRCUIT	3.000	PC																																																		
KVL1209A	US PLUS 3 ROTOR ARMS WASHING SYSTEM KIT	<table border="1"> <thead> <tr> <th>Code</th> <th>Description</th> <th>Qty</th> <th>UOM</th> </tr> </thead> <tbody> <tr> <td>0H2354A1</td> <td>XEVC-XEVL PLUS WASHING CIRCUIT PLAT</td> <td>1.000</td> <td>PC</td> </tr> <tr> <td>EL1450A0</td> <td>US SELF-CLEANING WATER SOLENOID</td> <td>4.000</td> <td>PC</td> </tr> <tr> <td>GN1526A0</td> <td>INT. D.=6.9 TH=1.8 O-RING</td> <td>9.000</td> <td>PC</td> </tr> <tr> <td>RC1018A0</td> <td>ZINC PLATED D12 ELASTIC CLAMP</td> <td>11.000</td> <td>PC</td> </tr> <tr> <td>RC1019A0</td> <td>D=10 ELASTIC CLAMP</td> <td>14.000</td> <td>PC</td> </tr> <tr> <td>RC1130A0</td> <td>130x2.6 CLAM</td> <td>1.000</td> <td>PC</td> </tr> <tr> <td>RC1131A0</td> <td>200x2.6 BLACK CLAMP</td> <td>3.000</td> <td>PC</td> </tr> <tr> <td>RC1242A0</td> <td>D=10 CLOSED CAP</td> <td>2.000</td> <td>PC</td> </tr> </tbody> </table>	Code	Description	Qty	UOM	0H2354A1	XEVC-XEVL PLUS WASHING CIRCUIT PLAT	1.000	PC	EL1450A0	US SELF-CLEANING WATER SOLENOID	4.000	PC	GN1526A0	INT. D.=6.9 TH=1.8 O-RING	9.000	PC	RC1018A0	ZINC PLATED D12 ELASTIC CLAMP	11.000	PC	RC1019A0	D=10 ELASTIC CLAMP	14.000	PC	RC1130A0	130x2.6 CLAM	1.000	PC	RC1131A0	200x2.6 BLACK CLAMP	3.000	PC	RC1242A0	D=10 CLOSED CAP	2.000	PC															
Code	Description	Qty	UOM																																																		
0H2354A1	XEVC-XEVL PLUS WASHING CIRCUIT PLAT	1.000	PC																																																		
EL1450A0	US SELF-CLEANING WATER SOLENOID	4.000	PC																																																		
GN1526A0	INT. D.=6.9 TH=1.8 O-RING	9.000	PC																																																		
RC1018A0	ZINC PLATED D12 ELASTIC CLAMP	11.000	PC																																																		
RC1019A0	D=10 ELASTIC CLAMP	14.000	PC																																																		
RC1130A0	130x2.6 CLAM	1.000	PC																																																		
RC1131A0	200x2.6 BLACK CLAMP	3.000	PC																																																		
RC1242A0	D=10 CLOSED CAP	2.000	PC																																																		



COMPONENT			SPARE PART																																																																																						
Code	Description	Image	Code	Description	Kit components																																																																																				
VL1185A	2 WAYS PLUS WASHING DISTRIBUTOR		KVL1209A	US PLUS 3 ROTOR ARMS WASHING SYSTEM KIT	<table border="1"> <thead> <tr> <th>Code</th> <th>Description</th> <th>Qty</th> <th>UOM</th> </tr> </thead> <tbody> <tr> <td>RC1356A0</td> <td>"STRAIGHT THREADED FEMALE END 8x1/4" BS</td> <td>1.000</td> <td>PC</td> </tr> <tr> <td>RC1414A1</td> <td>D11.5-12.5 SINGLE EAR HOSE CLAMP</td> <td>1.000</td> <td>PC</td> </tr> <tr> <td>TB2652A0</td> <td></td> <td>1.000</td> <td>PC</td> </tr> <tr> <td>TB2677A0</td> <td></td> <td>1.000</td> <td>PC</td> </tr> <tr> <td>TB2821A0</td> <td>EPDM 6X10 L=40MM PIPE</td> <td>4.000</td> <td>PC</td> </tr> <tr> <td>TB3004A0</td> <td>TB2820A L=550mm EPDM BLACK PIPE</td> <td>2.000</td> <td>PC</td> </tr> <tr> <td>TB3024C0</td> <td></td> <td>3.000</td> <td>PC</td> </tr> <tr> <td>TB3226A0</td> <td></td> <td>1.000</td> <td>PC</td> </tr> <tr> <td>TB3440A0</td> <td>TB3132A L=1050mm EPDM WHITE-BLUE PIPE</td> <td>1.000</td> <td>PC</td> </tr> <tr> <td>TB3614A0</td> <td>TB3614A0</td> <td>1.000</td> <td>PC</td> </tr> <tr> <td>VI1220A1</td> <td>4,2x12 TCB SELF-TAPPIN G SCREW</td> <td>1.000</td> <td>PC</td> </tr> <tr> <td>VL1019A0</td> <td>VIBRATION DETERGENT PUMP</td> <td>1.000</td> <td>PC</td> </tr> <tr> <td>VL1065A1</td> <td>1/4 MALE N.O. PRESSURE SWITCH</td> <td>1.000</td> <td>PC</td> </tr> <tr> <td>VL1102A1</td> <td>DETERGENT LINE FILTER + BARBED VNR 6 MM</td> <td>1.000</td> <td>PC</td> </tr> <tr> <td>VL1127A1</td> <td>6mm BARBED T-SHAPED FITTING</td> <td>2.000</td> <td>PC</td> </tr> <tr> <td>VL1128A1</td> <td>D6 BARBED CHECK VALVE</td> <td>2.000</td> <td>PC</td> </tr> <tr> <td>VL1166A0</td> <td>BB6-AR6 L FITTING</td> <td>4.000</td> <td>PC</td> </tr> <tr> <td>VL1167A2</td> <td>GN21 3 ROTOR ARMS B-B FLOW RESTRICTOR</td> <td>1.000</td> <td>PC</td> </tr> <tr> <td>VL1174C0</td> <td>D1.2 MM CALIBRATED NOZZLE</td> <td>1.000</td> <td>PC</td> </tr> <tr> <td>VL1186A0</td> <td>3 WAYS PLUS WASHING DISTRIBUTOR</td> <td>1.000</td> <td>PC</td> </tr> </tbody> </table>	Code	Description	Qty	UOM	RC1356A0	"STRAIGHT THREADED FEMALE END 8x1/4" BS	1.000	PC	RC1414A1	D11.5-12.5 SINGLE EAR HOSE CLAMP	1.000	PC	TB2652A0		1.000	PC	TB2677A0		1.000	PC	TB2821A0	EPDM 6X10 L=40MM PIPE	4.000	PC	TB3004A0	TB2820A L=550mm EPDM BLACK PIPE	2.000	PC	TB3024C0		3.000	PC	TB3226A0		1.000	PC	TB3440A0	TB3132A L=1050mm EPDM WHITE-BLUE PIPE	1.000	PC	TB3614A0	TB3614A0	1.000	PC	VI1220A1	4,2x12 TCB SELF-TAPPIN G SCREW	1.000	PC	VL1019A0	VIBRATION DETERGENT PUMP	1.000	PC	VL1065A1	1/4 MALE N.O. PRESSURE SWITCH	1.000	PC	VL1102A1	DETERGENT LINE FILTER + BARBED VNR 6 MM	1.000	PC	VL1127A1	6mm BARBED T-SHAPED FITTING	2.000	PC	VL1128A1	D6 BARBED CHECK VALVE	2.000	PC	VL1166A0	BB6-AR6 L FITTING	4.000	PC	VL1167A2	GN21 3 ROTOR ARMS B-B FLOW RESTRICTOR	1.000	PC	VL1174C0	D1.2 MM CALIBRATED NOZZLE	1.000	PC	VL1186A0	3 WAYS PLUS WASHING DISTRIBUTOR	1.000	PC
Code	Description	Qty	UOM																																																																																						
RC1356A0	"STRAIGHT THREADED FEMALE END 8x1/4" BS	1.000	PC																																																																																						
RC1414A1	D11.5-12.5 SINGLE EAR HOSE CLAMP	1.000	PC																																																																																						
TB2652A0		1.000	PC																																																																																						
TB2677A0		1.000	PC																																																																																						
TB2821A0	EPDM 6X10 L=40MM PIPE	4.000	PC																																																																																						
TB3004A0	TB2820A L=550mm EPDM BLACK PIPE	2.000	PC																																																																																						
TB3024C0		3.000	PC																																																																																						
TB3226A0		1.000	PC																																																																																						
TB3440A0	TB3132A L=1050mm EPDM WHITE-BLUE PIPE	1.000	PC																																																																																						
TB3614A0	TB3614A0	1.000	PC																																																																																						
VI1220A1	4,2x12 TCB SELF-TAPPIN G SCREW	1.000	PC																																																																																						
VL1019A0	VIBRATION DETERGENT PUMP	1.000	PC																																																																																						
VL1065A1	1/4 MALE N.O. PRESSURE SWITCH	1.000	PC																																																																																						
VL1102A1	DETERGENT LINE FILTER + BARBED VNR 6 MM	1.000	PC																																																																																						
VL1127A1	6mm BARBED T-SHAPED FITTING	2.000	PC																																																																																						
VL1128A1	D6 BARBED CHECK VALVE	2.000	PC																																																																																						
VL1166A0	BB6-AR6 L FITTING	4.000	PC																																																																																						
VL1167A2	GN21 3 ROTOR ARMS B-B FLOW RESTRICTOR	1.000	PC																																																																																						
VL1174C0	D1.2 MM CALIBRATED NOZZLE	1.000	PC																																																																																						
VL1186A0	3 WAYS PLUS WASHING DISTRIBUTOR	1.000	PC																																																																																						



COMPONENT			SPARE PART																																																											
Code	Description	Image	Code	Description	Kit components																																																									
VL1185A	2 WAYS PLUS WASHING DISTRIBUTOR		KVL1209A	US PLUS 3 ROTOR ARMS WASHING SYSTEM KIT	<table border="1"> <thead> <tr> <th>Code</th> <th>Description</th> <th>Qty</th> <th>UOM</th> </tr> </thead> <tbody> <tr> <td>VL1190A0</td> <td>PLUS WASHING SYSTEM INLET DISTRIBUTOR</td> <td>1.000</td> <td>PC</td> </tr> <tr> <td>VL1214A0</td> <td>BAYONET - 6mm BARBED NRV VALVE</td> <td>1.000</td> <td>PC</td> </tr> <tr> <td>VM1605A0</td> <td>CLIP TWIST LOCK DIAM. 10,2-12,7 MM</td> <td>3.000</td> <td>PC</td> </tr> <tr> <td>VM2172A0</td> <td>LOCKING CLIP FOR PUMP WITH CIRCUIT</td> <td>5.000</td> <td>PC</td> </tr> </tbody> </table>	Code	Description	Qty	UOM	VL1190A0	PLUS WASHING SYSTEM INLET DISTRIBUTOR	1.000	PC	VL1214A0	BAYONET - 6mm BARBED NRV VALVE	1.000	PC	VM1605A0	CLIP TWIST LOCK DIAM. 10,2-12,7 MM	3.000	PC	VM2172A0	LOCKING CLIP FOR PUMP WITH CIRCUIT	5.000	PC																																					
			Code	Description	Qty	UOM																																																								
VL1190A0	PLUS WASHING SYSTEM INLET DISTRIBUTOR	1.000	PC																																																											
VL1214A0	BAYONET - 6mm BARBED NRV VALVE	1.000	PC																																																											
VM1605A0	CLIP TWIST LOCK DIAM. 10,2-12,7 MM	3.000	PC																																																											
VM2172A0	LOCKING CLIP FOR PUMP WITH CIRCUIT	5.000	PC																																																											
KVL1207A	US PLUS 1 ROTOR ARM WASHING SYSTEM KIT	<table border="1"> <thead> <tr> <th>Code</th> <th>Description</th> <th>Qty</th> <th>UOM</th> </tr> </thead> <tbody> <tr> <td>0H2354A1</td> <td>XEVC-XEVL PLUS WASHING CIRCUIT PLAT</td> <td>1.000</td> <td>PC</td> </tr> <tr> <td>EL1450A0</td> <td>US SELF-CLEANING WATER SOLENOID</td> <td>3.000</td> <td>PC</td> </tr> <tr> <td>GN1526A0</td> <td>INT. D.=6.9 TH=1.8 O-RING</td> <td>7.000</td> <td>PC</td> </tr> <tr> <td>RC1018A0</td> <td>ZINC PLATED D12 ELASTIC CLAMP</td> <td>1.000</td> <td>PC</td> </tr> <tr> <td>RC1019A0</td> <td>D=10 ELASTIC CLAMP</td> <td>12.000</td> <td>PC</td> </tr> <tr> <td>RC1130A0</td> <td>130x2,6 CLAM</td> <td>1.000</td> <td>PC</td> </tr> <tr> <td>RC1131A0</td> <td>200x2,6 BLACK CLAMP</td> <td>2.000</td> <td>PC</td> </tr> <tr> <td>RC1242A0</td> <td>D=10 CLOSED CAP</td> <td>2.000</td> <td>PC</td> </tr> <tr> <td>RC1356A0</td> <td>"STRAIGHT" THREADED FEMALE END 8x1/4" BS</td> <td>1.000</td> <td>PC</td> </tr> <tr> <td>RC1414A1</td> <td>D11.5-12.5 SINGLE EAR HOSE CLAMP</td> <td>5.000</td> <td>PC</td> </tr> <tr> <td>TB2821A0</td> <td>EPDM 6X10 L=40MM PIPE</td> <td>4.000</td> <td>PC</td> </tr> <tr> <td>TB3004A0</td> <td>TB2820A L=550mm EPDM BLACK PIPE</td> <td>1.000</td> <td>PC</td> </tr> <tr> <td>TB3005B0</td> <td>TB3132A L=550mm EPDM WHITE-BLUE PIPE</td> <td>2.000</td> <td>PC</td> </tr> <tr> <td>TB3024C0</td> <td></td> <td>1.000</td> <td>PC</td> </tr> </tbody> </table>	Code	Description	Qty	UOM	0H2354A1	XEVC-XEVL PLUS WASHING CIRCUIT PLAT	1.000	PC	EL1450A0	US SELF-CLEANING WATER SOLENOID	3.000	PC	GN1526A0	INT. D.=6.9 TH=1.8 O-RING	7.000	PC	RC1018A0	ZINC PLATED D12 ELASTIC CLAMP	1.000	PC	RC1019A0	D=10 ELASTIC CLAMP	12.000	PC	RC1130A0	130x2,6 CLAM	1.000	PC	RC1131A0	200x2,6 BLACK CLAMP	2.000	PC	RC1242A0	D=10 CLOSED CAP	2.000	PC	RC1356A0	"STRAIGHT" THREADED FEMALE END 8x1/4" BS	1.000	PC	RC1414A1	D11.5-12.5 SINGLE EAR HOSE CLAMP	5.000	PC	TB2821A0	EPDM 6X10 L=40MM PIPE	4.000	PC	TB3004A0	TB2820A L=550mm EPDM BLACK PIPE	1.000	PC	TB3005B0	TB3132A L=550mm EPDM WHITE-BLUE PIPE	2.000	PC	TB3024C0		1.000	PC
Code	Description	Qty	UOM																																																											
0H2354A1	XEVC-XEVL PLUS WASHING CIRCUIT PLAT	1.000	PC																																																											
EL1450A0	US SELF-CLEANING WATER SOLENOID	3.000	PC																																																											
GN1526A0	INT. D.=6.9 TH=1.8 O-RING	7.000	PC																																																											
RC1018A0	ZINC PLATED D12 ELASTIC CLAMP	1.000	PC																																																											
RC1019A0	D=10 ELASTIC CLAMP	12.000	PC																																																											
RC1130A0	130x2,6 CLAM	1.000	PC																																																											
RC1131A0	200x2,6 BLACK CLAMP	2.000	PC																																																											
RC1242A0	D=10 CLOSED CAP	2.000	PC																																																											
RC1356A0	"STRAIGHT" THREADED FEMALE END 8x1/4" BS	1.000	PC																																																											
RC1414A1	D11.5-12.5 SINGLE EAR HOSE CLAMP	5.000	PC																																																											
TB2821A0	EPDM 6X10 L=40MM PIPE	4.000	PC																																																											
TB3004A0	TB2820A L=550mm EPDM BLACK PIPE	1.000	PC																																																											
TB3005B0	TB3132A L=550mm EPDM WHITE-BLUE PIPE	2.000	PC																																																											
TB3024C0		1.000	PC																																																											



COMPONENT			SPARE PART																																																																																					
Code	Description	Image	Code	Description	Kit components																																																																																			
VL1185A	2 WAYS PLUS WASHING DISTRIBUTOR		KVL1207A	US PLUS 1 ROTOR ARM WASHING SYSTEM KIT	<table border="1"> <thead> <tr> <th>Code</th> <th>Description</th> <th>Qty</th> <th>UOM</th> </tr> </thead> <tbody> <tr> <td>TB3225B0</td> <td>TB2820A-TAN K-WASHYNG SYS CONNECTION</td> <td>1.000</td> <td>PC</td> </tr> <tr> <td>TB3252A0</td> <td>TB3252A0</td> <td>1.000</td> <td>PC</td> </tr> <tr> <td>TB3614A0</td> <td>TB3614A0</td> <td>1.000</td> <td>PC</td> </tr> <tr> <td>VI1220A1</td> <td>4,2x12 TCB SELF-TAPPIN G SCREW</td> <td>1.000</td> <td>PC</td> </tr> <tr> <td>VL1019A0</td> <td>VIBRATION DETERGENT PUMP</td> <td>1.000</td> <td>PC</td> </tr> <tr> <td>VL1047A1</td> <td>D6 PIPE HOLDER - D8 J.G. TERMINAL</td> <td>1.000</td> <td>PC</td> </tr> <tr> <td>VL1102A1</td> <td>DETERGENT LINE FILTER + BARBED VNR 6 MM</td> <td>1.000</td> <td>PC</td> </tr> <tr> <td>VL1127A1</td> <td>6mm BARBED T-SHAPED FITTING</td> <td>1.000</td> <td>PC</td> </tr> <tr> <td>VL1128A1</td> <td>D6 BARBED CHECK VALVE</td> <td>1.000</td> <td>PC</td> </tr> <tr> <td>VL1166A0</td> <td>BB6-AR6 L FITTING</td> <td>3.000</td> <td>PC</td> </tr> <tr> <td>VL1174C0</td> <td>D1.2 MM CALIBRATED NOZZLE</td> <td>1.000</td> <td>PC</td> </tr> <tr> <td>VL1185A0</td> <td>2 WAYS PLUS WASHING DISTRIBUTOR</td> <td>1.000</td> <td>PC</td> </tr> <tr> <td>VL1190A0</td> <td>PLUS WASHING SYSTEM INLET DISTRIBUTOR</td> <td>1.000</td> <td>PC</td> </tr> <tr> <td>VL1214A0</td> <td>BAYONET - 6mm BARBED NRV VALVE</td> <td>1.000</td> <td>PC</td> </tr> <tr> <td>VL1398A0</td> <td>1/4 M N.O. CIL PRESSURE SWITCH</td> <td>1.000</td> <td>PC</td> </tr> <tr> <td>VM1605A0</td> <td>CLIP TWIST LOCK DIAM. 10,2-12,7 MM</td> <td>3.000</td> <td>PC</td> </tr> <tr> <td>VM2172A0</td> <td>LOCKING CLIP FOR PUMP WITH CIRCUIT</td> <td>4.000</td> <td>PC</td> </tr> </tbody> </table>	Code	Description	Qty	UOM	TB3225B0	TB2820A-TAN K-WASHYNG SYS CONNECTION	1.000	PC	TB3252A0	TB3252A0	1.000	PC	TB3614A0	TB3614A0	1.000	PC	VI1220A1	4,2x12 TCB SELF-TAPPIN G SCREW	1.000	PC	VL1019A0	VIBRATION DETERGENT PUMP	1.000	PC	VL1047A1	D6 PIPE HOLDER - D8 J.G. TERMINAL	1.000	PC	VL1102A1	DETERGENT LINE FILTER + BARBED VNR 6 MM	1.000	PC	VL1127A1	6mm BARBED T-SHAPED FITTING	1.000	PC	VL1128A1	D6 BARBED CHECK VALVE	1.000	PC	VL1166A0	BB6-AR6 L FITTING	3.000	PC	VL1174C0	D1.2 MM CALIBRATED NOZZLE	1.000	PC	VL1185A0	2 WAYS PLUS WASHING DISTRIBUTOR	1.000	PC	VL1190A0	PLUS WASHING SYSTEM INLET DISTRIBUTOR	1.000	PC	VL1214A0	BAYONET - 6mm BARBED NRV VALVE	1.000	PC	VL1398A0	1/4 M N.O. CIL PRESSURE SWITCH	1.000	PC	VM1605A0	CLIP TWIST LOCK DIAM. 10,2-12,7 MM	3.000	PC	VM2172A0	LOCKING CLIP FOR PUMP WITH CIRCUIT	4.000	PC	KVL1183A	1 ROTOR ARM PLUS CLEANING SYSTEM KIT	<table border="1"> <thead> <tr> <th>Code</th> <th>Description</th> <th>Qty</th> <th>UOM</th> </tr> </thead> <tbody> <tr> <td>0H2354A1</td> <td>XEVC-XEVL PLUS WASHING CIRCUIT PLAT</td> <td>1.000</td> <td>PC</td> </tr> </tbody> </table>	Code	Description	Qty	UOM	0H2354A1	XEVC-XEVL PLUS WASHING CIRCUIT PLAT	1.000	PC
			Code	Description	Qty	UOM																																																																																		
TB3225B0	TB2820A-TAN K-WASHYNG SYS CONNECTION	1.000	PC																																																																																					
TB3252A0	TB3252A0	1.000	PC																																																																																					
TB3614A0	TB3614A0	1.000	PC																																																																																					
VI1220A1	4,2x12 TCB SELF-TAPPIN G SCREW	1.000	PC																																																																																					
VL1019A0	VIBRATION DETERGENT PUMP	1.000	PC																																																																																					
VL1047A1	D6 PIPE HOLDER - D8 J.G. TERMINAL	1.000	PC																																																																																					
VL1102A1	DETERGENT LINE FILTER + BARBED VNR 6 MM	1.000	PC																																																																																					
VL1127A1	6mm BARBED T-SHAPED FITTING	1.000	PC																																																																																					
VL1128A1	D6 BARBED CHECK VALVE	1.000	PC																																																																																					
VL1166A0	BB6-AR6 L FITTING	3.000	PC																																																																																					
VL1174C0	D1.2 MM CALIBRATED NOZZLE	1.000	PC																																																																																					
VL1185A0	2 WAYS PLUS WASHING DISTRIBUTOR	1.000	PC																																																																																					
VL1190A0	PLUS WASHING SYSTEM INLET DISTRIBUTOR	1.000	PC																																																																																					
VL1214A0	BAYONET - 6mm BARBED NRV VALVE	1.000	PC																																																																																					
VL1398A0	1/4 M N.O. CIL PRESSURE SWITCH	1.000	PC																																																																																					
VM1605A0	CLIP TWIST LOCK DIAM. 10,2-12,7 MM	3.000	PC																																																																																					
VM2172A0	LOCKING CLIP FOR PUMP WITH CIRCUIT	4.000	PC																																																																																					
Code	Description	Qty	UOM																																																																																					
0H2354A1	XEVC-XEVL PLUS WASHING CIRCUIT PLAT	1.000	PC																																																																																					



COMPONENT			SPARE PART																																																																																						
Code	Description	Image	Code	Description	Kit components																																																																																				
VL1185A	2 WAYS PLUS WASHING DISTRIBUTOR		KVL1183A	1 ROTOR ARM PLUS CLEANING SYSTEM KIT	<table border="1"> <thead> <tr> <th>Code</th> <th>Description</th> <th>Qty</th> <th>UOM</th> </tr> </thead> <tbody> <tr> <td>EL1440A0</td> <td>WATER SELF CLEANING VALVE</td> <td>3.000</td> <td>PC</td> </tr> <tr> <td>GN1526A0</td> <td>INT. D.=6.9 TH=1.8 O-RIN</td> <td>7.000</td> <td>PC</td> </tr> <tr> <td>RC1018A0</td> <td>ZINC PLATED D12 ELASTIC CLAMP</td> <td>1.000</td> <td>PC</td> </tr> <tr> <td>RC1019A0</td> <td>D=10 ELASTIC CLAMP</td> <td>12.000</td> <td>PC</td> </tr> <tr> <td>RC1130A0</td> <td>130x2,6 CLAM</td> <td>1.000</td> <td>PC</td> </tr> <tr> <td>RC1131A0</td> <td>200x2,6 BLACK CLAMP</td> <td>2.000</td> <td>PC</td> </tr> <tr> <td>RC1242A0</td> <td>D=10 CLOSED CAP</td> <td>2.000</td> <td>PC</td> </tr> <tr> <td>RC1356A0</td> <td>"STRAIGHT THREADED FEMALE END 8x1/4" BS</td> <td>1.000</td> <td>PC</td> </tr> <tr> <td>RC1414A1</td> <td>D11.5-12.5 SINGLE EAR HOSE CLAMP</td> <td>1.000</td> <td>PC</td> </tr> <tr> <td>TB2821A0</td> <td>EPDM 6X10 L=40MM PIPE</td> <td>4.000</td> <td>PC</td> </tr> <tr> <td>TB3004A0</td> <td>TB2820A L=550mm EPDM BLACK PIPE</td> <td>1.000</td> <td>PC</td> </tr> <tr> <td>TB3005B0</td> <td>TB3132A L=550mm EPDM WHITE-BLUE PIPE</td> <td>1.000</td> <td>PC</td> </tr> <tr> <td>TB3225B0</td> <td>TB2820A-TAN K-WASHYNG SYS CONNECTION</td> <td>1.000</td> <td>PC</td> </tr> <tr> <td>TB3252A0</td> <td>TB3252A0</td> <td>1.000</td> <td>PC</td> </tr> <tr> <td>TB3614A0</td> <td>TB3614A0</td> <td>1.000</td> <td>PC</td> </tr> <tr> <td>VI1220A1</td> <td>4,2x12 TCB SELF-TAPPIN G SCREW</td> <td>1.000</td> <td>PC</td> </tr> <tr> <td>VL1019A0</td> <td>VIBRATION DETERGENT PUMP</td> <td>1.000</td> <td>PC</td> </tr> <tr> <td>VL1047A1</td> <td>D6 PIPE HOLDER - D8 J.G. TERMINAL</td> <td>1.000</td> <td>PC</td> </tr> <tr> <td>VL1102A1</td> <td>DETERGENT LINE FILTER + BARBED VNR 6 MM</td> <td>1.000</td> <td>PC</td> </tr> <tr> <td>VL1128A1</td> <td>D6 BARBED CHECK VALVE</td> <td>1.000</td> <td>PC</td> </tr> </tbody> </table>	Code	Description	Qty	UOM	EL1440A0	WATER SELF CLEANING VALVE	3.000	PC	GN1526A0	INT. D.=6.9 TH=1.8 O-RIN	7.000	PC	RC1018A0	ZINC PLATED D12 ELASTIC CLAMP	1.000	PC	RC1019A0	D=10 ELASTIC CLAMP	12.000	PC	RC1130A0	130x2,6 CLAM	1.000	PC	RC1131A0	200x2,6 BLACK CLAMP	2.000	PC	RC1242A0	D=10 CLOSED CAP	2.000	PC	RC1356A0	"STRAIGHT THREADED FEMALE END 8x1/4" BS	1.000	PC	RC1414A1	D11.5-12.5 SINGLE EAR HOSE CLAMP	1.000	PC	TB2821A0	EPDM 6X10 L=40MM PIPE	4.000	PC	TB3004A0	TB2820A L=550mm EPDM BLACK PIPE	1.000	PC	TB3005B0	TB3132A L=550mm EPDM WHITE-BLUE PIPE	1.000	PC	TB3225B0	TB2820A-TAN K-WASHYNG SYS CONNECTION	1.000	PC	TB3252A0	TB3252A0	1.000	PC	TB3614A0	TB3614A0	1.000	PC	VI1220A1	4,2x12 TCB SELF-TAPPIN G SCREW	1.000	PC	VL1019A0	VIBRATION DETERGENT PUMP	1.000	PC	VL1047A1	D6 PIPE HOLDER - D8 J.G. TERMINAL	1.000	PC	VL1102A1	DETERGENT LINE FILTER + BARBED VNR 6 MM	1.000	PC	VL1128A1	D6 BARBED CHECK VALVE	1.000	PC
					Code	Description	Qty	UOM																																																																																	
					EL1440A0	WATER SELF CLEANING VALVE	3.000	PC																																																																																	
					GN1526A0	INT. D.=6.9 TH=1.8 O-RIN	7.000	PC																																																																																	
					RC1018A0	ZINC PLATED D12 ELASTIC CLAMP	1.000	PC																																																																																	
					RC1019A0	D=10 ELASTIC CLAMP	12.000	PC																																																																																	
					RC1130A0	130x2,6 CLAM	1.000	PC																																																																																	
					RC1131A0	200x2,6 BLACK CLAMP	2.000	PC																																																																																	
					RC1242A0	D=10 CLOSED CAP	2.000	PC																																																																																	
					RC1356A0	"STRAIGHT THREADED FEMALE END 8x1/4" BS	1.000	PC																																																																																	
					RC1414A1	D11.5-12.5 SINGLE EAR HOSE CLAMP	1.000	PC																																																																																	
					TB2821A0	EPDM 6X10 L=40MM PIPE	4.000	PC																																																																																	
					TB3004A0	TB2820A L=550mm EPDM BLACK PIPE	1.000	PC																																																																																	
					TB3005B0	TB3132A L=550mm EPDM WHITE-BLUE PIPE	1.000	PC																																																																																	
					TB3225B0	TB2820A-TAN K-WASHYNG SYS CONNECTION	1.000	PC																																																																																	
					TB3252A0	TB3252A0	1.000	PC																																																																																	
					TB3614A0	TB3614A0	1.000	PC																																																																																	
					VI1220A1	4,2x12 TCB SELF-TAPPIN G SCREW	1.000	PC																																																																																	
					VL1019A0	VIBRATION DETERGENT PUMP	1.000	PC																																																																																	
					VL1047A1	D6 PIPE HOLDER - D8 J.G. TERMINAL	1.000	PC																																																																																	
VL1102A1	DETERGENT LINE FILTER + BARBED VNR 6 MM	1.000	PC																																																																																						
VL1128A1	D6 BARBED CHECK VALVE	1.000	PC																																																																																						



COMPONENT			SPARE PART																																																			
Code	Description	Image	Code	Description	Kit components																																																	
VL1185A	2 WAYS PLUS WASHING DISTRIBUTOR		KVL1183A	1 ROTOR ARM PLUS CLEANING SYSTEM KIT	<table border="1"> <thead> <tr> <th>Code</th> <th>Description</th> <th>Qty</th> <th>UOM</th> </tr> </thead> <tbody> <tr> <td>VL1166A0</td> <td>BB6-AR6 L FITTING</td> <td>3.000</td> <td>PC</td> </tr> <tr> <td>VL1174C0</td> <td>D1.2 MM CALIBRATED NOZZLE</td> <td>1.000</td> <td>PC</td> </tr> <tr> <td>VL1185A0</td> <td>2 WAYS PLUS WASHING DISTRIBUTOR</td> <td>1.000</td> <td>PC</td> </tr> <tr> <td>VL1190A0</td> <td>PLUS WASHING SYSTEM INLET DISTRIBUTOR</td> <td>1.000</td> <td>PC</td> </tr> <tr> <td>VL1214A0</td> <td>BAYONET - 6mm BARBED NRV VALVE</td> <td>1.000</td> <td>PC</td> </tr> <tr> <td>VL1398A0</td> <td>1/4 M N.O. CIL PRESSURE SWITCH</td> <td>1.000</td> <td>PC</td> </tr> <tr> <td>VM1605A0</td> <td>CLIP TWIST LOCK DIAM. 10,2-12,7 MM</td> <td>3.000</td> <td>PC</td> </tr> <tr> <td>VM2172A0</td> <td>LOCKING CLIP FOR PUMP WITH CIRCUIT</td> <td>4.000</td> <td>PC</td> </tr> </tbody> </table>	Code	Description	Qty	UOM	VL1166A0	BB6-AR6 L FITTING	3.000	PC	VL1174C0	D1.2 MM CALIBRATED NOZZLE	1.000	PC	VL1185A0	2 WAYS PLUS WASHING DISTRIBUTOR	1.000	PC	VL1190A0	PLUS WASHING SYSTEM INLET DISTRIBUTOR	1.000	PC	VL1214A0	BAYONET - 6mm BARBED NRV VALVE	1.000	PC	VL1398A0	1/4 M N.O. CIL PRESSURE SWITCH	1.000	PC	VM1605A0	CLIP TWIST LOCK DIAM. 10,2-12,7 MM	3.000	PC	VM2172A0	LOCKING CLIP FOR PUMP WITH CIRCUIT	4.000	PC													
			Code	Description	Qty	UOM																																																
VL1166A0	BB6-AR6 L FITTING	3.000	PC																																																			
VL1174C0	D1.2 MM CALIBRATED NOZZLE	1.000	PC																																																			
VL1185A0	2 WAYS PLUS WASHING DISTRIBUTOR	1.000	PC																																																			
VL1190A0	PLUS WASHING SYSTEM INLET DISTRIBUTOR	1.000	PC																																																			
VL1214A0	BAYONET - 6mm BARBED NRV VALVE	1.000	PC																																																			
VL1398A0	1/4 M N.O. CIL PRESSURE SWITCH	1.000	PC																																																			
VM1605A0	CLIP TWIST LOCK DIAM. 10,2-12,7 MM	3.000	PC																																																			
VM2172A0	LOCKING CLIP FOR PUMP WITH CIRCUIT	4.000	PC																																																			
KVL0683A	>12/2019 1 ROTOR ARM PLUS WASH PUMP KIT	<table border="1"> <thead> <tr> <th>Code</th> <th>Description</th> <th>Qty</th> <th>UOM</th> </tr> </thead> <tbody> <tr> <td>GN1526A0</td> <td>INT. D.=6.9 TH=1.8 O-RIN</td> <td>2.000</td> <td>PC</td> </tr> <tr> <td>RC1019A0</td> <td>D=10 ELASTIC CLAMP</td> <td>4.000</td> <td>PC</td> </tr> <tr> <td>RC1130A0</td> <td>130x2.6 CLAM</td> <td>1.000</td> <td>PC</td> </tr> <tr> <td>RC1131A0</td> <td>200x2.6 BLACK CLAMP</td> <td>2.000</td> <td>PC</td> </tr> <tr> <td>RC1242A0</td> <td>D=10 CLOSED CAP</td> <td>2.000</td> <td>PC</td> </tr> <tr> <td>TB2821A0</td> <td>EPDM 6X10 L=40MM PIPE</td> <td>3.000</td> <td>PC</td> </tr> <tr> <td>VL1019A0</td> <td>VIBRATION DETERGENT PUMP</td> <td>1.000</td> <td>PC</td> </tr> <tr> <td>VL1128A1</td> <td>D6 BARBED CHECK VALVE</td> <td>1.000</td> <td>PC</td> </tr> <tr> <td>VL1174C0</td> <td>D1.2 MM CALIBRATED NOZZLE</td> <td>1.000</td> <td>PC</td> </tr> <tr> <td>VL1185A0</td> <td>2 WAYS PLUS WASHING DISTRIBUTOR</td> <td>1.000</td> <td>PC</td> </tr> <tr> <td>VL1190A0</td> <td>PLUS WASHING SYSTEM INLET DISTRIBUTOR</td> <td>1.000</td> <td>PC</td> </tr> <tr> <td>VM2172A0</td> <td>LOCKING CLIP FOR PUMP WITH CIRCUIT</td> <td>1.000</td> <td>PC</td> </tr> </tbody> </table>	Code	Description	Qty	UOM	GN1526A0	INT. D.=6.9 TH=1.8 O-RIN	2.000	PC	RC1019A0	D=10 ELASTIC CLAMP	4.000	PC	RC1130A0	130x2.6 CLAM	1.000	PC	RC1131A0	200x2.6 BLACK CLAMP	2.000	PC	RC1242A0	D=10 CLOSED CAP	2.000	PC	TB2821A0	EPDM 6X10 L=40MM PIPE	3.000	PC	VL1019A0	VIBRATION DETERGENT PUMP	1.000	PC	VL1128A1	D6 BARBED CHECK VALVE	1.000	PC	VL1174C0	D1.2 MM CALIBRATED NOZZLE	1.000	PC	VL1185A0	2 WAYS PLUS WASHING DISTRIBUTOR	1.000	PC	VL1190A0	PLUS WASHING SYSTEM INLET DISTRIBUTOR	1.000	PC	VM2172A0	LOCKING CLIP FOR PUMP WITH CIRCUIT	1.000	PC
Code	Description	Qty	UOM																																																			
GN1526A0	INT. D.=6.9 TH=1.8 O-RIN	2.000	PC																																																			
RC1019A0	D=10 ELASTIC CLAMP	4.000	PC																																																			
RC1130A0	130x2.6 CLAM	1.000	PC																																																			
RC1131A0	200x2.6 BLACK CLAMP	2.000	PC																																																			
RC1242A0	D=10 CLOSED CAP	2.000	PC																																																			
TB2821A0	EPDM 6X10 L=40MM PIPE	3.000	PC																																																			
VL1019A0	VIBRATION DETERGENT PUMP	1.000	PC																																																			
VL1128A1	D6 BARBED CHECK VALVE	1.000	PC																																																			
VL1174C0	D1.2 MM CALIBRATED NOZZLE	1.000	PC																																																			
VL1185A0	2 WAYS PLUS WASHING DISTRIBUTOR	1.000	PC																																																			
VL1190A0	PLUS WASHING SYSTEM INLET DISTRIBUTOR	1.000	PC																																																			
VM2172A0	LOCKING CLIP FOR PUMP WITH CIRCUIT	1.000	PC																																																			



COMPONENT			SPARE PART																																																																																											
Code	Description	Image	Code	Description	Kit components																																																																																									
VL1190A	PLUS WASHING SYSTEM INLET DISTRIBUTOR		KVL1209A	US PLUS 3 ROTOR ARMS WASHING SYSTEM KIT	<table border="1"> <thead> <tr> <th>Code</th> <th>Description</th> <th>Qty</th> <th>UOM</th> </tr> </thead> <tbody> <tr> <td>0H2354A1</td> <td>XEVC-XEVL PLUS WASHING CIRCUIT PLAT</td> <td>1.000</td> <td>PC</td> </tr> <tr> <td>EL1450A0</td> <td>US SELF-CLEANING WATER SOLENOID</td> <td>4.000</td> <td>PC</td> </tr> <tr> <td>GN1526A0</td> <td>INT. D.=6.9 TH=1.8 O-RING</td> <td>9.000</td> <td>PC</td> </tr> <tr> <td>RC1018A0</td> <td>ZINC PLATED D12 ELASTIC CLAMP</td> <td>11.000</td> <td>PC</td> </tr> <tr> <td>RC1019A0</td> <td>D=10 ELASTIC CLAMP</td> <td>14.000</td> <td>PC</td> </tr> <tr> <td>RC1130A0</td> <td>130x2.6 CLAMP</td> <td>1.000</td> <td>PC</td> </tr> <tr> <td>RC1131A0</td> <td>200x2.6 BLACK CLAMP</td> <td>3.000</td> <td>PC</td> </tr> <tr> <td>RC1242A0</td> <td>D=10 CLOSED CAP</td> <td>2.000</td> <td>PC</td> </tr> <tr> <td>RC1356A0</td> <td>*STRAIGHT THREADED FEMALE END 8x1/4" BS</td> <td>1.000</td> <td>PC</td> </tr> <tr> <td>RC1414A1</td> <td>D11.5-12.5 SINGLE EAR HOSE CLAMP</td> <td>1.000</td> <td>PC</td> </tr> <tr> <td>TB2652A0</td> <td></td> <td>1.000</td> <td>PC</td> </tr> <tr> <td>TB2677A0</td> <td></td> <td>1.000</td> <td>PC</td> </tr> <tr> <td>TB2821A0</td> <td>EPDM 6X10 L=40MM PIPE</td> <td>4.000</td> <td>PC</td> </tr> <tr> <td>TB3004A0</td> <td>TB2820A L=550mm EPDM BLACK PIPE</td> <td>2.000</td> <td>PC</td> </tr> <tr> <td>TB3024C0</td> <td></td> <td>3.000</td> <td>PC</td> </tr> <tr> <td>TB3226A0</td> <td></td> <td>1.000</td> <td>PC</td> </tr> <tr> <td>TB3440A0</td> <td>TB3132A L=1050mm EPDM WHITE-BLUE PIPE</td> <td>1.000</td> <td>PC</td> </tr> <tr> <td>TB3614A0</td> <td>TB3614A0</td> <td>1.000</td> <td>PC</td> </tr> <tr> <td>VH1220A1</td> <td>4,2x12 TCB SELF-TAPPING SCREW</td> <td>1.000</td> <td>PC</td> </tr> <tr> <td>VL1019A0</td> <td>VIBRATION DETERGENT PUMP</td> <td>1.000</td> <td>PC</td> </tr> <tr> <td>VL1065A1</td> <td>1/4 MALE N.O. PRESSURE SWITCH</td> <td>1.000</td> <td>PC</td> </tr> </tbody> </table>		Code	Description	Qty	UOM	0H2354A1	XEVC-XEVL PLUS WASHING CIRCUIT PLAT	1.000	PC	EL1450A0	US SELF-CLEANING WATER SOLENOID	4.000	PC	GN1526A0	INT. D.=6.9 TH=1.8 O-RING	9.000	PC	RC1018A0	ZINC PLATED D12 ELASTIC CLAMP	11.000	PC	RC1019A0	D=10 ELASTIC CLAMP	14.000	PC	RC1130A0	130x2.6 CLAMP	1.000	PC	RC1131A0	200x2.6 BLACK CLAMP	3.000	PC	RC1242A0	D=10 CLOSED CAP	2.000	PC	RC1356A0	*STRAIGHT THREADED FEMALE END 8x1/4" BS	1.000	PC	RC1414A1	D11.5-12.5 SINGLE EAR HOSE CLAMP	1.000	PC	TB2652A0		1.000	PC	TB2677A0		1.000	PC	TB2821A0	EPDM 6X10 L=40MM PIPE	4.000	PC	TB3004A0	TB2820A L=550mm EPDM BLACK PIPE	2.000	PC	TB3024C0		3.000	PC	TB3226A0		1.000	PC	TB3440A0	TB3132A L=1050mm EPDM WHITE-BLUE PIPE	1.000	PC	TB3614A0	TB3614A0	1.000	PC	VH1220A1	4,2x12 TCB SELF-TAPPING SCREW	1.000	PC	VL1019A0	VIBRATION DETERGENT PUMP	1.000	PC	VL1065A1	1/4 MALE N.O. PRESSURE SWITCH	1.000	PC
Code	Description	Qty	UOM																																																																																											
0H2354A1	XEVC-XEVL PLUS WASHING CIRCUIT PLAT	1.000	PC																																																																																											
EL1450A0	US SELF-CLEANING WATER SOLENOID	4.000	PC																																																																																											
GN1526A0	INT. D.=6.9 TH=1.8 O-RING	9.000	PC																																																																																											
RC1018A0	ZINC PLATED D12 ELASTIC CLAMP	11.000	PC																																																																																											
RC1019A0	D=10 ELASTIC CLAMP	14.000	PC																																																																																											
RC1130A0	130x2.6 CLAMP	1.000	PC																																																																																											
RC1131A0	200x2.6 BLACK CLAMP	3.000	PC																																																																																											
RC1242A0	D=10 CLOSED CAP	2.000	PC																																																																																											
RC1356A0	*STRAIGHT THREADED FEMALE END 8x1/4" BS	1.000	PC																																																																																											
RC1414A1	D11.5-12.5 SINGLE EAR HOSE CLAMP	1.000	PC																																																																																											
TB2652A0		1.000	PC																																																																																											
TB2677A0		1.000	PC																																																																																											
TB2821A0	EPDM 6X10 L=40MM PIPE	4.000	PC																																																																																											
TB3004A0	TB2820A L=550mm EPDM BLACK PIPE	2.000	PC																																																																																											
TB3024C0		3.000	PC																																																																																											
TB3226A0		1.000	PC																																																																																											
TB3440A0	TB3132A L=1050mm EPDM WHITE-BLUE PIPE	1.000	PC																																																																																											
TB3614A0	TB3614A0	1.000	PC																																																																																											
VH1220A1	4,2x12 TCB SELF-TAPPING SCREW	1.000	PC																																																																																											
VL1019A0	VIBRATION DETERGENT PUMP	1.000	PC																																																																																											
VL1065A1	1/4 MALE N.O. PRESSURE SWITCH	1.000	PC																																																																																											



COMPONENT			SPARE PART																																																																																					
Code	Description	Image	Code	Description	Kit components																																																																																			
VL1190A	PLUS WASHING SYSTEM INLET DISTRIBUTOR		KVL1209A	US PLUS 3 ROTOR ARMS WASHING SYSTEM KIT	<table border="1"> <thead> <tr> <th>Code</th> <th>Description</th> <th>Qty</th> <th>UOM</th> </tr> </thead> <tbody> <tr> <td>VL1102A1</td> <td>DETERGENT LINE FILTER + BARBED VNR 6 MM</td> <td>1.000</td> <td>PC</td> </tr> <tr> <td>VL1127A1</td> <td>6mm BARBED T-SHAPED FITTING</td> <td>2.000</td> <td>PC</td> </tr> <tr> <td>VL1128A1</td> <td>D6 BARBED CHECK VALVE</td> <td>2.000</td> <td>PC</td> </tr> <tr> <td>VL1166A0</td> <td>BB6-AR6 L FITTING</td> <td>4.000</td> <td>PC</td> </tr> <tr> <td>VL1167A2</td> <td>GN21 3 ROTOR ARMS B-B FLOW RESTRICTOR</td> <td>1.000</td> <td>PC</td> </tr> <tr> <td>VL1174C0</td> <td>D1.2 MM CALIBRATED NOZZLE</td> <td>1.000</td> <td>PC</td> </tr> <tr> <td>VL1186A0</td> <td>3 WAYS PLUS WASHING DISTRIBUTOR</td> <td>1.000</td> <td>PC</td> </tr> <tr> <td>VL1190A0</td> <td>PLUS WASHING SYSTEM INLET DISTRIBUTOR</td> <td>1.000</td> <td>PC</td> </tr> <tr> <td>VL1214A0</td> <td>BAYONET - 6mm BARBED NRV VALVE</td> <td>1.000</td> <td>PC</td> </tr> <tr> <td>VM1605A0</td> <td>CLIP TWIST LOCK DIAM. 10,2-12,7 MM</td> <td>3.000</td> <td>PC</td> </tr> <tr> <td>VM2172A0</td> <td>LOCKING CLIP FOR PUMP WITH CIRCUIT</td> <td>5.000</td> <td>PC</td> </tr> </tbody> </table>	Code	Description	Qty	UOM	VL1102A1	DETERGENT LINE FILTER + BARBED VNR 6 MM	1.000	PC	VL1127A1	6mm BARBED T-SHAPED FITTING	2.000	PC	VL1128A1	D6 BARBED CHECK VALVE	2.000	PC	VL1166A0	BB6-AR6 L FITTING	4.000	PC	VL1167A2	GN21 3 ROTOR ARMS B-B FLOW RESTRICTOR	1.000	PC	VL1174C0	D1.2 MM CALIBRATED NOZZLE	1.000	PC	VL1186A0	3 WAYS PLUS WASHING DISTRIBUTOR	1.000	PC	VL1190A0	PLUS WASHING SYSTEM INLET DISTRIBUTOR	1.000	PC	VL1214A0	BAYONET - 6mm BARBED NRV VALVE	1.000	PC	VM1605A0	CLIP TWIST LOCK DIAM. 10,2-12,7 MM	3.000	PC	VM2172A0	LOCKING CLIP FOR PUMP WITH CIRCUIT	5.000	PC	KVL1208A	US PLUS 2 ROTOR ARMS WASHING SYSTEM KIT	<table border="1"> <thead> <tr> <th>Code</th> <th>Description</th> <th>Qty</th> <th>UOM</th> </tr> </thead> <tbody> <tr> <td>0H2354A1</td> <td>XEVC-XEVL PLUS WASHING CIRCUIT PLAT</td> <td>1.000</td> <td>PC</td> </tr> <tr> <td>EL1450A0</td> <td>US SELF-CLEANING WATER SOLENOID</td> <td>4.000</td> <td>PC</td> </tr> <tr> <td>GN1526A0</td> <td>INT. D.=6.9 TH=1.8 O-RING</td> <td>9.000</td> <td>PC</td> </tr> <tr> <td>RC1018A0</td> <td>ZINC PLATED D12 ELASTIC CLAMP</td> <td>3.000</td> <td>PC</td> </tr> <tr> <td>RC1019A0</td> <td>D=10 ELASTIC CLAMP</td> <td>2.000</td> <td>PC</td> </tr> <tr> <td>RC1130A0</td> <td>130x2,6 CLAM</td> <td>1.000</td> <td>PC</td> </tr> <tr> <td>RC1131A0</td> <td>200x2,6 BLACK CLAMP</td> <td>3.000</td> <td>PC</td> </tr> </tbody> </table>	Code	Description	Qty	UOM	0H2354A1	XEVC-XEVL PLUS WASHING CIRCUIT PLAT	1.000	PC	EL1450A0	US SELF-CLEANING WATER SOLENOID	4.000	PC	GN1526A0	INT. D.=6.9 TH=1.8 O-RING	9.000	PC	RC1018A0	ZINC PLATED D12 ELASTIC CLAMP	3.000	PC	RC1019A0	D=10 ELASTIC CLAMP	2.000	PC	RC1130A0	130x2,6 CLAM	1.000	PC	RC1131A0	200x2,6 BLACK CLAMP	3.000	PC
			Code	Description	Qty	UOM																																																																																		
VL1102A1	DETERGENT LINE FILTER + BARBED VNR 6 MM	1.000	PC																																																																																					
VL1127A1	6mm BARBED T-SHAPED FITTING	2.000	PC																																																																																					
VL1128A1	D6 BARBED CHECK VALVE	2.000	PC																																																																																					
VL1166A0	BB6-AR6 L FITTING	4.000	PC																																																																																					
VL1167A2	GN21 3 ROTOR ARMS B-B FLOW RESTRICTOR	1.000	PC																																																																																					
VL1174C0	D1.2 MM CALIBRATED NOZZLE	1.000	PC																																																																																					
VL1186A0	3 WAYS PLUS WASHING DISTRIBUTOR	1.000	PC																																																																																					
VL1190A0	PLUS WASHING SYSTEM INLET DISTRIBUTOR	1.000	PC																																																																																					
VL1214A0	BAYONET - 6mm BARBED NRV VALVE	1.000	PC																																																																																					
VM1605A0	CLIP TWIST LOCK DIAM. 10,2-12,7 MM	3.000	PC																																																																																					
VM2172A0	LOCKING CLIP FOR PUMP WITH CIRCUIT	5.000	PC																																																																																					
Code	Description	Qty	UOM																																																																																					
0H2354A1	XEVC-XEVL PLUS WASHING CIRCUIT PLAT	1.000	PC																																																																																					
EL1450A0	US SELF-CLEANING WATER SOLENOID	4.000	PC																																																																																					
GN1526A0	INT. D.=6.9 TH=1.8 O-RING	9.000	PC																																																																																					
RC1018A0	ZINC PLATED D12 ELASTIC CLAMP	3.000	PC																																																																																					
RC1019A0	D=10 ELASTIC CLAMP	2.000	PC																																																																																					
RC1130A0	130x2,6 CLAM	1.000	PC																																																																																					
RC1131A0	200x2,6 BLACK CLAMP	3.000	PC																																																																																					





COMPONENT			SPARE PART																																																																										
Code	Description	Image	Code	Description	Kit components																																																																								
VL1190A	PLUS WASHING SYSTEM INLET DISTRIBUTOR		KVL1208A	US PLUS 2 ROTOR ARMS WASHING SYSTEM KIT	<table border="1"> <thead> <tr> <th>Code</th> <th>Description</th> <th>Qty</th> <th>UOM</th> </tr> </thead> <tbody> <tr> <td>RC1242A0</td> <td>D=10 CLOSED CAP</td> <td>2.000</td> <td>PC</td> </tr> <tr> <td>RC1356A0</td> <td>"STRAIGHT THREADED FEMALE END 8x1/4" BS</td> <td>1.000</td> <td>PC</td> </tr> <tr> <td>RC1414A1</td> <td>D11.5-12.5 SINGLE EAR HOSE CLAMP</td> <td>4.000</td> <td>PC</td> </tr> <tr> <td>TB2821A0</td> <td>EPDM 6X10 L=40MM PIPE</td> <td>6.000</td> <td>PC</td> </tr> <tr> <td>TB2994A0</td> <td>HOOD DETERGENT PIPE</td> <td>1.000</td> <td>PC</td> </tr> <tr> <td>TB3004A0</td> <td>TB2820A L=550mm EPDM BLACK PIPE</td> <td>1.000</td> <td>PC</td> </tr> <tr> <td>TB3005B0</td> <td>TB3132A L=550mm EPDM WHITE-BLUE PIPE</td> <td>1.000</td> <td>PC</td> </tr> <tr> <td>TB3440A0</td> <td>TB3132A L=1050mm EPDM WHITE-BLUE PIPE</td> <td>1.000</td> <td>PC</td> </tr> <tr> <td>VL1019A0</td> <td>VIBRATION DETERGENT PUMP</td> <td>1.000</td> <td>PC</td> </tr> <tr> <td>VL1047A1</td> <td>D6 PIPE HOLDER - D8 J.G. TERMINAL</td> <td>1.000</td> <td>PC</td> </tr> <tr> <td>VL1065A1</td> <td>1/4 MALE N.O. PRESSURE SWITCH</td> <td>1.000</td> <td>PC</td> </tr> <tr> <td>VL1102A1</td> <td>DETERGENT LINE FILTER + BARBED VNR 6 MM</td> <td>1.000</td> <td>PC</td> </tr> <tr> <td>VL1128A1</td> <td>D6 BARBED CHECK VALVE</td> <td>2.000</td> <td>PC</td> </tr> <tr> <td>VL1141A1</td> <td>BB6-BB6 STRAIGHT CONNECTION</td> <td>1.000</td> <td>PC</td> </tr> <tr> <td>VL1166A0</td> <td>BB6-AR6 L FITTING</td> <td>4.000</td> <td>PC</td> </tr> <tr> <td>VL1174C0</td> <td>D1.2 MM CALIBRATED NOZZLE</td> <td>1.000</td> <td>PC</td> </tr> <tr> <td>VL1186A0</td> <td>3 WAYS PLUS WASHING DISTRIBUTOR</td> <td>1.000</td> <td>PC</td> </tr> </tbody> </table>	Code	Description	Qty	UOM	RC1242A0	D=10 CLOSED CAP	2.000	PC	RC1356A0	"STRAIGHT THREADED FEMALE END 8x1/4" BS	1.000	PC	RC1414A1	D11.5-12.5 SINGLE EAR HOSE CLAMP	4.000	PC	TB2821A0	EPDM 6X10 L=40MM PIPE	6.000	PC	TB2994A0	HOOD DETERGENT PIPE	1.000	PC	TB3004A0	TB2820A L=550mm EPDM BLACK PIPE	1.000	PC	TB3005B0	TB3132A L=550mm EPDM WHITE-BLUE PIPE	1.000	PC	TB3440A0	TB3132A L=1050mm EPDM WHITE-BLUE PIPE	1.000	PC	VL1019A0	VIBRATION DETERGENT PUMP	1.000	PC	VL1047A1	D6 PIPE HOLDER - D8 J.G. TERMINAL	1.000	PC	VL1065A1	1/4 MALE N.O. PRESSURE SWITCH	1.000	PC	VL1102A1	DETERGENT LINE FILTER + BARBED VNR 6 MM	1.000	PC	VL1128A1	D6 BARBED CHECK VALVE	2.000	PC	VL1141A1	BB6-BB6 STRAIGHT CONNECTION	1.000	PC	VL1166A0	BB6-AR6 L FITTING	4.000	PC	VL1174C0	D1.2 MM CALIBRATED NOZZLE	1.000	PC	VL1186A0	3 WAYS PLUS WASHING DISTRIBUTOR	1.000	PC
					Code	Description	Qty	UOM																																																																					
					RC1242A0	D=10 CLOSED CAP	2.000	PC																																																																					
					RC1356A0	"STRAIGHT THREADED FEMALE END 8x1/4" BS	1.000	PC																																																																					
					RC1414A1	D11.5-12.5 SINGLE EAR HOSE CLAMP	4.000	PC																																																																					
					TB2821A0	EPDM 6X10 L=40MM PIPE	6.000	PC																																																																					
					TB2994A0	HOOD DETERGENT PIPE	1.000	PC																																																																					
					TB3004A0	TB2820A L=550mm EPDM BLACK PIPE	1.000	PC																																																																					
					TB3005B0	TB3132A L=550mm EPDM WHITE-BLUE PIPE	1.000	PC																																																																					
					TB3440A0	TB3132A L=1050mm EPDM WHITE-BLUE PIPE	1.000	PC																																																																					
					VL1019A0	VIBRATION DETERGENT PUMP	1.000	PC																																																																					
					VL1047A1	D6 PIPE HOLDER - D8 J.G. TERMINAL	1.000	PC																																																																					
					VL1065A1	1/4 MALE N.O. PRESSURE SWITCH	1.000	PC																																																																					
					VL1102A1	DETERGENT LINE FILTER + BARBED VNR 6 MM	1.000	PC																																																																					
					VL1128A1	D6 BARBED CHECK VALVE	2.000	PC																																																																					
					VL1141A1	BB6-BB6 STRAIGHT CONNECTION	1.000	PC																																																																					
					VL1166A0	BB6-AR6 L FITTING	4.000	PC																																																																					
					VL1174C0	D1.2 MM CALIBRATED NOZZLE	1.000	PC																																																																					
					VL1186A0	3 WAYS PLUS WASHING DISTRIBUTOR	1.000	PC																																																																					



COMPONENT			SPARE PART																																																											
Code	Description	Image	Code	Description	Kit components																																																									
VL1190A	PLUS WASHING SYSTEM INLET DISTRIBUTOR		KVL1208A	US PLUS 2 ROTOR ARMS WASHING SYSTEM KIT	<table border="1"> <thead> <tr> <th>Code</th> <th>Description</th> <th>Qty</th> <th>UOM</th> </tr> </thead> <tbody> <tr> <td>VL1190A0</td> <td>PLUS WASHING SYSTEM INLET DISTRIBUTOR</td> <td>1.000</td> <td>PC</td> </tr> <tr> <td>VL1214A0</td> <td>BAYONET - 6mm BARBED NRV VALVE</td> <td>1.000</td> <td>PC</td> </tr> <tr> <td>VM1605A0</td> <td>CLIP TWIST LOCK DIAM. 10,2-12,7 MM</td> <td>3.000</td> <td>PC</td> </tr> <tr> <td>VM2172A0</td> <td>LOCKING CLIP FOR PUMP WITH CIRCUIT</td> <td>5.000</td> <td>PC</td> </tr> </tbody> </table>	Code	Description	Qty	UOM	VL1190A0	PLUS WASHING SYSTEM INLET DISTRIBUTOR	1.000	PC	VL1214A0	BAYONET - 6mm BARBED NRV VALVE	1.000	PC	VM1605A0	CLIP TWIST LOCK DIAM. 10,2-12,7 MM	3.000	PC	VM2172A0	LOCKING CLIP FOR PUMP WITH CIRCUIT	5.000	PC																																					
			Code	Description	Qty	UOM																																																								
VL1190A0	PLUS WASHING SYSTEM INLET DISTRIBUTOR	1.000	PC																																																											
VL1214A0	BAYONET - 6mm BARBED NRV VALVE	1.000	PC																																																											
VM1605A0	CLIP TWIST LOCK DIAM. 10,2-12,7 MM	3.000	PC																																																											
VM2172A0	LOCKING CLIP FOR PUMP WITH CIRCUIT	5.000	PC																																																											
KVL1207A	US PLUS 1 ROTOR ARM WASHING SYSTEM KIT	<table border="1"> <thead> <tr> <th>Code</th> <th>Description</th> <th>Qty</th> <th>UOM</th> </tr> </thead> <tbody> <tr> <td>0H2354A1</td> <td>XEVC-XEVL PLUS WASHING CIRCUIT PLAT</td> <td>1.000</td> <td>PC</td> </tr> <tr> <td>EL1450A0</td> <td>US SELF-CLEANING WATER SOLENOID</td> <td>3.000</td> <td>PC</td> </tr> <tr> <td>GN1526A0</td> <td>INT. D.=6.9 TH=1.8 O-RING</td> <td>7.000</td> <td>PC</td> </tr> <tr> <td>RC1018A0</td> <td>ZINC PLATED D12 ELASTIC CLAMP</td> <td>1.000</td> <td>PC</td> </tr> <tr> <td>RC1019A0</td> <td>D=10 ELASTIC CLAMP</td> <td>12.000</td> <td>PC</td> </tr> <tr> <td>RC1130A0</td> <td>130x2,6 CLAM</td> <td>1.000</td> <td>PC</td> </tr> <tr> <td>RC1131A0</td> <td>200x2,6 BLACK CLAMP</td> <td>2.000</td> <td>PC</td> </tr> <tr> <td>RC1242A0</td> <td>D=10 CLOSED CAP</td> <td>2.000</td> <td>PC</td> </tr> <tr> <td>RC1356A0</td> <td>"STRAIGHT THREADED FEMALE END 8x1/4" BS</td> <td>1.000</td> <td>PC</td> </tr> <tr> <td>RC1414A1</td> <td>D11.5-12.5 SINGLE EAR HOSE CLAMP</td> <td>5.000</td> <td>PC</td> </tr> <tr> <td>TB2821A0</td> <td>EPDM 6X10 L=40MM PIPE</td> <td>4.000</td> <td>PC</td> </tr> <tr> <td>TB3004A0</td> <td>TB2820A L=550mm EPDM BLACK PIPE</td> <td>1.000</td> <td>PC</td> </tr> <tr> <td>TB3005B0</td> <td>TB3132A L=550mm EPDM WHITE-BLUE PIPE</td> <td>2.000</td> <td>PC</td> </tr> <tr> <td>TB3024C0</td> <td></td> <td>1.000</td> <td>PC</td> </tr> </tbody> </table>	Code	Description	Qty	UOM	0H2354A1	XEVC-XEVL PLUS WASHING CIRCUIT PLAT	1.000	PC	EL1450A0	US SELF-CLEANING WATER SOLENOID	3.000	PC	GN1526A0	INT. D.=6.9 TH=1.8 O-RING	7.000	PC	RC1018A0	ZINC PLATED D12 ELASTIC CLAMP	1.000	PC	RC1019A0	D=10 ELASTIC CLAMP	12.000	PC	RC1130A0	130x2,6 CLAM	1.000	PC	RC1131A0	200x2,6 BLACK CLAMP	2.000	PC	RC1242A0	D=10 CLOSED CAP	2.000	PC	RC1356A0	"STRAIGHT THREADED FEMALE END 8x1/4" BS	1.000	PC	RC1414A1	D11.5-12.5 SINGLE EAR HOSE CLAMP	5.000	PC	TB2821A0	EPDM 6X10 L=40MM PIPE	4.000	PC	TB3004A0	TB2820A L=550mm EPDM BLACK PIPE	1.000	PC	TB3005B0	TB3132A L=550mm EPDM WHITE-BLUE PIPE	2.000	PC	TB3024C0		1.000	PC
Code	Description	Qty	UOM																																																											
0H2354A1	XEVC-XEVL PLUS WASHING CIRCUIT PLAT	1.000	PC																																																											
EL1450A0	US SELF-CLEANING WATER SOLENOID	3.000	PC																																																											
GN1526A0	INT. D.=6.9 TH=1.8 O-RING	7.000	PC																																																											
RC1018A0	ZINC PLATED D12 ELASTIC CLAMP	1.000	PC																																																											
RC1019A0	D=10 ELASTIC CLAMP	12.000	PC																																																											
RC1130A0	130x2,6 CLAM	1.000	PC																																																											
RC1131A0	200x2,6 BLACK CLAMP	2.000	PC																																																											
RC1242A0	D=10 CLOSED CAP	2.000	PC																																																											
RC1356A0	"STRAIGHT THREADED FEMALE END 8x1/4" BS	1.000	PC																																																											
RC1414A1	D11.5-12.5 SINGLE EAR HOSE CLAMP	5.000	PC																																																											
TB2821A0	EPDM 6X10 L=40MM PIPE	4.000	PC																																																											
TB3004A0	TB2820A L=550mm EPDM BLACK PIPE	1.000	PC																																																											
TB3005B0	TB3132A L=550mm EPDM WHITE-BLUE PIPE	2.000	PC																																																											
TB3024C0		1.000	PC																																																											



COMPONENT			SPARE PART																																																																																					
Code	Description	Image	Code	Description	Kit components																																																																																			
VL1190A	PLUS WASHING SYSTEM INLET DISTRIBUTOR		KVL1207A	US PLUS 1 ROTOR ARM WASHING SYSTEM KIT	<table border="1"> <thead> <tr> <th>Code</th> <th>Description</th> <th>Qty</th> <th>UOM</th> </tr> </thead> <tbody> <tr> <td>TB3225B0</td> <td>TB2820A-TAN K-WASHYNG SYS CONNECTION</td> <td>1.000</td> <td>PC</td> </tr> <tr> <td>TB3252A0</td> <td>TB3252A0</td> <td>1.000</td> <td>PC</td> </tr> <tr> <td>TB3614A0</td> <td>TB3614A0</td> <td>1.000</td> <td>PC</td> </tr> <tr> <td>VI1220A1</td> <td>4,2x12 TCB SELF-TAPPIN G SCREW</td> <td>1.000</td> <td>PC</td> </tr> <tr> <td>VL1019A0</td> <td>VIBRATION DETERGENT PUMP</td> <td>1.000</td> <td>PC</td> </tr> <tr> <td>VL1047A1</td> <td>D6 PIPE HOLDER - D8 J.G. TERMINAL</td> <td>1.000</td> <td>PC</td> </tr> <tr> <td>VL1102A1</td> <td>DETERGENT LINE FILTER + BARBED VNR 6 MM</td> <td>1.000</td> <td>PC</td> </tr> <tr> <td>VL1127A1</td> <td>6mm BARBED T-SHAPED FITTING</td> <td>1.000</td> <td>PC</td> </tr> <tr> <td>VL1128A1</td> <td>D6 BARBED CHECK VALVE</td> <td>1.000</td> <td>PC</td> </tr> <tr> <td>VL1166A0</td> <td>BB6-AR6 L FITTING</td> <td>3.000</td> <td>PC</td> </tr> <tr> <td>VL1174C0</td> <td>D1.2 MM CALIBRATED NOZZLE</td> <td>1.000</td> <td>PC</td> </tr> <tr> <td>VL1185A0</td> <td>2 WAYS PLUS WASHING DISTRIBUTOR</td> <td>1.000</td> <td>PC</td> </tr> <tr> <td>VL1190A0</td> <td>PLUS WASHING SYSTEM INLET DISTRIBUTOR</td> <td>1.000</td> <td>PC</td> </tr> <tr> <td>VL1214A0</td> <td>BAYONET - 6mm BARBED NRV VALVE</td> <td>1.000</td> <td>PC</td> </tr> <tr> <td>VL1398A0</td> <td>1/4 M N.O. CIL PRESSURE SWITCH</td> <td>1.000</td> <td>PC</td> </tr> <tr> <td>VM1605A0</td> <td>CLIP TWIST LOCK DIAM. 10,2-12,7 MM</td> <td>3.000</td> <td>PC</td> </tr> <tr> <td>VM2172A0</td> <td>LOCKING CLIP FOR PUMP WITH CIRCUIT</td> <td>4.000</td> <td>PC</td> </tr> </tbody> </table>	Code	Description	Qty	UOM	TB3225B0	TB2820A-TAN K-WASHYNG SYS CONNECTION	1.000	PC	TB3252A0	TB3252A0	1.000	PC	TB3614A0	TB3614A0	1.000	PC	VI1220A1	4,2x12 TCB SELF-TAPPIN G SCREW	1.000	PC	VL1019A0	VIBRATION DETERGENT PUMP	1.000	PC	VL1047A1	D6 PIPE HOLDER - D8 J.G. TERMINAL	1.000	PC	VL1102A1	DETERGENT LINE FILTER + BARBED VNR 6 MM	1.000	PC	VL1127A1	6mm BARBED T-SHAPED FITTING	1.000	PC	VL1128A1	D6 BARBED CHECK VALVE	1.000	PC	VL1166A0	BB6-AR6 L FITTING	3.000	PC	VL1174C0	D1.2 MM CALIBRATED NOZZLE	1.000	PC	VL1185A0	2 WAYS PLUS WASHING DISTRIBUTOR	1.000	PC	VL1190A0	PLUS WASHING SYSTEM INLET DISTRIBUTOR	1.000	PC	VL1214A0	BAYONET - 6mm BARBED NRV VALVE	1.000	PC	VL1398A0	1/4 M N.O. CIL PRESSURE SWITCH	1.000	PC	VM1605A0	CLIP TWIST LOCK DIAM. 10,2-12,7 MM	3.000	PC	VM2172A0	LOCKING CLIP FOR PUMP WITH CIRCUIT	4.000	PC	KVL1187A	3 ROTOR ARMS PLUS EU CLEANING SYSTEM KIT	<table border="1"> <thead> <tr> <th>Code</th> <th>Description</th> <th>Qty</th> <th>UOM</th> </tr> </thead> <tbody> <tr> <td>0H2354A1</td> <td>XEVC-XEVL PLUS WASHING CIRCUIT PLAT</td> <td>1.000</td> <td>PC</td> </tr> </tbody> </table>	Code	Description	Qty	UOM	0H2354A1	XEVC-XEVL PLUS WASHING CIRCUIT PLAT	1.000	PC
			Code	Description	Qty	UOM																																																																																		
TB3225B0	TB2820A-TAN K-WASHYNG SYS CONNECTION	1.000	PC																																																																																					
TB3252A0	TB3252A0	1.000	PC																																																																																					
TB3614A0	TB3614A0	1.000	PC																																																																																					
VI1220A1	4,2x12 TCB SELF-TAPPIN G SCREW	1.000	PC																																																																																					
VL1019A0	VIBRATION DETERGENT PUMP	1.000	PC																																																																																					
VL1047A1	D6 PIPE HOLDER - D8 J.G. TERMINAL	1.000	PC																																																																																					
VL1102A1	DETERGENT LINE FILTER + BARBED VNR 6 MM	1.000	PC																																																																																					
VL1127A1	6mm BARBED T-SHAPED FITTING	1.000	PC																																																																																					
VL1128A1	D6 BARBED CHECK VALVE	1.000	PC																																																																																					
VL1166A0	BB6-AR6 L FITTING	3.000	PC																																																																																					
VL1174C0	D1.2 MM CALIBRATED NOZZLE	1.000	PC																																																																																					
VL1185A0	2 WAYS PLUS WASHING DISTRIBUTOR	1.000	PC																																																																																					
VL1190A0	PLUS WASHING SYSTEM INLET DISTRIBUTOR	1.000	PC																																																																																					
VL1214A0	BAYONET - 6mm BARBED NRV VALVE	1.000	PC																																																																																					
VL1398A0	1/4 M N.O. CIL PRESSURE SWITCH	1.000	PC																																																																																					
VM1605A0	CLIP TWIST LOCK DIAM. 10,2-12,7 MM	3.000	PC																																																																																					
VM2172A0	LOCKING CLIP FOR PUMP WITH CIRCUIT	4.000	PC																																																																																					
Code	Description	Qty	UOM																																																																																					
0H2354A1	XEVC-XEVL PLUS WASHING CIRCUIT PLAT	1.000	PC																																																																																					

COMPONENT			SPARE PART																																																																																														
Code	Description	Image	Code	Description	Kit components																																																																																												
VL1190A	PLUS WASHING SYSTEM INLET DISTRIBUTOR		KVL1187A	3 ROTOR ARMS PLUS EU CLEANING SYSTEM KIT	<table border="1"> <thead> <tr> <th>Code</th> <th>Description</th> <th>Qty</th> <th>UOM</th> </tr> </thead> <tbody> <tr> <td>EL1440A0</td> <td>WATER SELF CLEANING VALVE</td> <td>4.000</td> <td>PC</td> </tr> <tr> <td>GN1526A0</td> <td>INT. D.=6.9 TH=1.8 O-RIN</td> <td>9.000</td> <td>PC</td> </tr> <tr> <td>RC1018A0</td> <td>ZINC PLATED D12 ELASTIC CLAMP</td> <td>11.000</td> <td>PC</td> </tr> <tr> <td>RC1019A0</td> <td>D=10 ELASTIC CLAMP</td> <td>14.000</td> <td>PC</td> </tr> <tr> <td>RC1130A0</td> <td>130x2.6 CLAM</td> <td>1.000</td> <td>PC</td> </tr> <tr> <td>RC1131A0</td> <td>200x2.6 BLACK CLAMP</td> <td>3.000</td> <td>PC</td> </tr> <tr> <td>RC1242A0</td> <td>D=10 CLOSED CAP</td> <td>2.000</td> <td>PC</td> </tr> <tr> <td>RC1356A0</td> <td>"STRAIGHT THREADED FEMALE END 8x1/4" BS</td> <td>1.000</td> <td>PC</td> </tr> <tr> <td>RC1414A1</td> <td>D11.5-12.5 SINGLE EAR HOSE CLAMP</td> <td>1.000</td> <td>PC</td> </tr> <tr> <td>TB2652A0</td> <td></td> <td>1.000</td> <td>PC</td> </tr> <tr> <td>TB2677A0</td> <td></td> <td>1.000</td> <td>PC</td> </tr> <tr> <td>TB2821A0</td> <td>EPDM 6X10 L=40MM PIPE</td> <td>4.000</td> <td>PC</td> </tr> <tr> <td>TB3004A0</td> <td>TB2820A L=550mm EPDM BLACK PIPE</td> <td>2.000</td> <td>PC</td> </tr> <tr> <td>TB3024C0</td> <td></td> <td>3.000</td> <td>PC</td> </tr> <tr> <td>TB3226A0</td> <td></td> <td>1.000</td> <td>PC</td> </tr> <tr> <td>TB3440A0</td> <td>TB3132A L=1050mm EPDM WHITE-BLUE PIPE</td> <td>1.000</td> <td>PC</td> </tr> <tr> <td>TB3614A0</td> <td>TB3614A0</td> <td>1.000</td> <td>PC</td> </tr> <tr> <td>VI1220A1</td> <td>4,2x12 TCB SELF-TAPPIN G SCREW</td> <td>1.000</td> <td>PC</td> </tr> <tr> <td>VL1019A0</td> <td>VIBRATION DETERGENT PUMP</td> <td>1.000</td> <td>PC</td> </tr> <tr> <td>VL1047A1</td> <td>D6 PIPE HOLDER - D8 J.G. TERMINAL</td> <td>1.000</td> <td>PC</td> </tr> <tr> <td>VL1065A1</td> <td>1/4 MALE N.O. PRESSURE SWITCH</td> <td>1.000</td> <td>PC</td> </tr> <tr> <td>VL1102A1</td> <td>DETERGENT LINE FILTER + BARBED VNR 6 MM</td> <td>1.000</td> <td>PC</td> </tr> </tbody> </table>	Code	Description	Qty	UOM	EL1440A0	WATER SELF CLEANING VALVE	4.000	PC	GN1526A0	INT. D.=6.9 TH=1.8 O-RIN	9.000	PC	RC1018A0	ZINC PLATED D12 ELASTIC CLAMP	11.000	PC	RC1019A0	D=10 ELASTIC CLAMP	14.000	PC	RC1130A0	130x2.6 CLAM	1.000	PC	RC1131A0	200x2.6 BLACK CLAMP	3.000	PC	RC1242A0	D=10 CLOSED CAP	2.000	PC	RC1356A0	"STRAIGHT THREADED FEMALE END 8x1/4" BS	1.000	PC	RC1414A1	D11.5-12.5 SINGLE EAR HOSE CLAMP	1.000	PC	TB2652A0		1.000	PC	TB2677A0		1.000	PC	TB2821A0	EPDM 6X10 L=40MM PIPE	4.000	PC	TB3004A0	TB2820A L=550mm EPDM BLACK PIPE	2.000	PC	TB3024C0		3.000	PC	TB3226A0		1.000	PC	TB3440A0	TB3132A L=1050mm EPDM WHITE-BLUE PIPE	1.000	PC	TB3614A0	TB3614A0	1.000	PC	VI1220A1	4,2x12 TCB SELF-TAPPIN G SCREW	1.000	PC	VL1019A0	VIBRATION DETERGENT PUMP	1.000	PC	VL1047A1	D6 PIPE HOLDER - D8 J.G. TERMINAL	1.000	PC	VL1065A1	1/4 MALE N.O. PRESSURE SWITCH	1.000	PC	VL1102A1	DETERGENT LINE FILTER + BARBED VNR 6 MM	1.000	PC
Code	Description	Qty	UOM																																																																																														
EL1440A0	WATER SELF CLEANING VALVE	4.000	PC																																																																																														
GN1526A0	INT. D.=6.9 TH=1.8 O-RIN	9.000	PC																																																																																														
RC1018A0	ZINC PLATED D12 ELASTIC CLAMP	11.000	PC																																																																																														
RC1019A0	D=10 ELASTIC CLAMP	14.000	PC																																																																																														
RC1130A0	130x2.6 CLAM	1.000	PC																																																																																														
RC1131A0	200x2.6 BLACK CLAMP	3.000	PC																																																																																														
RC1242A0	D=10 CLOSED CAP	2.000	PC																																																																																														
RC1356A0	"STRAIGHT THREADED FEMALE END 8x1/4" BS	1.000	PC																																																																																														
RC1414A1	D11.5-12.5 SINGLE EAR HOSE CLAMP	1.000	PC																																																																																														
TB2652A0		1.000	PC																																																																																														
TB2677A0		1.000	PC																																																																																														
TB2821A0	EPDM 6X10 L=40MM PIPE	4.000	PC																																																																																														
TB3004A0	TB2820A L=550mm EPDM BLACK PIPE	2.000	PC																																																																																														
TB3024C0		3.000	PC																																																																																														
TB3226A0		1.000	PC																																																																																														
TB3440A0	TB3132A L=1050mm EPDM WHITE-BLUE PIPE	1.000	PC																																																																																														
TB3614A0	TB3614A0	1.000	PC																																																																																														
VI1220A1	4,2x12 TCB SELF-TAPPIN G SCREW	1.000	PC																																																																																														
VL1019A0	VIBRATION DETERGENT PUMP	1.000	PC																																																																																														
VL1047A1	D6 PIPE HOLDER - D8 J.G. TERMINAL	1.000	PC																																																																																														
VL1065A1	1/4 MALE N.O. PRESSURE SWITCH	1.000	PC																																																																																														
VL1102A1	DETERGENT LINE FILTER + BARBED VNR 6 MM	1.000	PC																																																																																														



COMPONENT			SPARE PART																																														
Code	Description	Image	Code	Description	Kit components																																												
VL1190A	PLUS WASHING SYSTEM INLET DISTRIBUTOR		KVL1187A	3 ROTOR ARMS PLUS EU CLEANING SYSTEM KIT	<table border="1"> <thead> <tr> <th>Code</th> <th>Description</th> <th>Qty</th> <th>UOM</th> </tr> </thead> <tbody> <tr> <td>VL1127A1</td> <td>6mm BARBED T-SHAPED FITTING</td> <td>2.000</td> <td>PC</td> </tr> <tr> <td>VL1128A1</td> <td>D6 BARBED CHECK VALVE</td> <td>2.000</td> <td>PC</td> </tr> <tr> <td>VL1166A0</td> <td>BB6-AR6 L FITTING</td> <td>4.000</td> <td>PC</td> </tr> <tr> <td>VL1167A2</td> <td>GN21 3 ROTOR ARMS B-B FLOW RESTRICTOR</td> <td>1.000</td> <td>PC</td> </tr> <tr> <td>VL1174C0</td> <td>D1.2 MM CALIBRATED NOZZLE</td> <td>1.000</td> <td>PC</td> </tr> <tr> <td>VL1186A0</td> <td>3 WAYS PLUS WASHING DISTRIBUTOR</td> <td>1.000</td> <td>PC</td> </tr> <tr> <td>VL1190A0</td> <td>PLUS WASHING SYSTEM INLET DISTRIBUTOR</td> <td>1.000</td> <td>PC</td> </tr> <tr> <td>VL1214A0</td> <td>BAYONET - 6mm BARBED NRV VALVE</td> <td>1.000</td> <td>PC</td> </tr> <tr> <td>VM1605A0</td> <td>CLIP TWIST LOCK DIAM. 10,2-12,7 MM</td> <td>3.000</td> <td>PC</td> </tr> <tr> <td>VM2172A0</td> <td>LOCKING CLIP FOR PUMP WITH CIRCUIT</td> <td>5.000</td> <td>PC</td> </tr> </tbody> </table>	Code	Description	Qty	UOM	VL1127A1	6mm BARBED T-SHAPED FITTING	2.000	PC	VL1128A1	D6 BARBED CHECK VALVE	2.000	PC	VL1166A0	BB6-AR6 L FITTING	4.000	PC	VL1167A2	GN21 3 ROTOR ARMS B-B FLOW RESTRICTOR	1.000	PC	VL1174C0	D1.2 MM CALIBRATED NOZZLE	1.000	PC	VL1186A0	3 WAYS PLUS WASHING DISTRIBUTOR	1.000	PC	VL1190A0	PLUS WASHING SYSTEM INLET DISTRIBUTOR	1.000	PC	VL1214A0	BAYONET - 6mm BARBED NRV VALVE	1.000	PC	VM1605A0	CLIP TWIST LOCK DIAM. 10,2-12,7 MM	3.000	PC	VM2172A0	LOCKING CLIP FOR PUMP WITH CIRCUIT	5.000	PC
			Code	Description	Qty	UOM																																											
VL1127A1	6mm BARBED T-SHAPED FITTING	2.000	PC																																														
VL1128A1	D6 BARBED CHECK VALVE	2.000	PC																																														
VL1166A0	BB6-AR6 L FITTING	4.000	PC																																														
VL1167A2	GN21 3 ROTOR ARMS B-B FLOW RESTRICTOR	1.000	PC																																														
VL1174C0	D1.2 MM CALIBRATED NOZZLE	1.000	PC																																														
VL1186A0	3 WAYS PLUS WASHING DISTRIBUTOR	1.000	PC																																														
VL1190A0	PLUS WASHING SYSTEM INLET DISTRIBUTOR	1.000	PC																																														
VL1214A0	BAYONET - 6mm BARBED NRV VALVE	1.000	PC																																														
VM1605A0	CLIP TWIST LOCK DIAM. 10,2-12,7 MM	3.000	PC																																														
VM2172A0	LOCKING CLIP FOR PUMP WITH CIRCUIT	5.000	PC																																														
KVL1184A	2 ROTOR ARMS PLUS EU CLEANING SYSTEM KIT	<table border="1"> <thead> <tr> <th>Code</th> <th>Description</th> <th>Qty</th> <th>UOM</th> </tr> </thead> <tbody> <tr> <td>0H2354A1</td> <td>XEVC-XEVL PLUS WASHING CIRCUIT PLAT</td> <td>1.000</td> <td>PC</td> </tr> <tr> <td>EL1440A0</td> <td>WATER SELF CLEANING VALVE</td> <td>4.000</td> <td>PC</td> </tr> <tr> <td>GN1526A0</td> <td>INT. D.=6.9 TH=1.8 O-RIN</td> <td>9.000</td> <td>PC</td> </tr> <tr> <td>RC1018A0</td> <td>ZINC PLATED D12 ELASTIC CLAMP</td> <td>2.000</td> <td>PC</td> </tr> <tr> <td>RC1019A0</td> <td>D=10 ELASTIC CLAMP</td> <td>13.000</td> <td>PC</td> </tr> <tr> <td>RC1130A0</td> <td>130x2.6 CLAM</td> <td>1.000</td> <td>PC</td> </tr> <tr> <td>RC1131A0</td> <td>200x2.6 BLACK CLAMP</td> <td>3.000</td> <td>PC</td> </tr> <tr> <td>RC1242A0</td> <td>D=10 CLOSED CAP</td> <td>2.000</td> <td>PC</td> </tr> </tbody> </table>	Code	Description	Qty	UOM	0H2354A1	XEVC-XEVL PLUS WASHING CIRCUIT PLAT	1.000	PC	EL1440A0	WATER SELF CLEANING VALVE	4.000	PC	GN1526A0	INT. D.=6.9 TH=1.8 O-RIN	9.000	PC	RC1018A0	ZINC PLATED D12 ELASTIC CLAMP	2.000	PC	RC1019A0	D=10 ELASTIC CLAMP	13.000	PC	RC1130A0	130x2.6 CLAM	1.000	PC	RC1131A0	200x2.6 BLACK CLAMP	3.000	PC	RC1242A0	D=10 CLOSED CAP	2.000	PC											
Code	Description	Qty	UOM																																														
0H2354A1	XEVC-XEVL PLUS WASHING CIRCUIT PLAT	1.000	PC																																														
EL1440A0	WATER SELF CLEANING VALVE	4.000	PC																																														
GN1526A0	INT. D.=6.9 TH=1.8 O-RIN	9.000	PC																																														
RC1018A0	ZINC PLATED D12 ELASTIC CLAMP	2.000	PC																																														
RC1019A0	D=10 ELASTIC CLAMP	13.000	PC																																														
RC1130A0	130x2.6 CLAM	1.000	PC																																														
RC1131A0	200x2.6 BLACK CLAMP	3.000	PC																																														
RC1242A0	D=10 CLOSED CAP	2.000	PC																																														



COMPONENT			SPARE PART																																																																											
Code	Description	Image	Code	Description	Kit components																																																																									
VL1190A	PLUS WASHING SYSTEM INLET DISTRIBUTOR		KVL1184A	2 ROTOR ARMS PLUS EU CLEANING SYSTEM KIT	<table border="1"> <thead> <tr> <th>Code</th> <th>Description</th> <th>Qty</th> <th>UOM</th> </tr> </thead> <tbody> <tr> <td>RC1356A0</td> <td>"STRAIGHT THREADED FEMALE END 8x1/4" BS</td> <td>1.000</td> <td>PC</td> </tr> <tr> <td>RC1414A1</td> <td>D11.5-12.5 SINGLE EAR HOSE CLAMP</td> <td>1.000</td> <td>PC</td> </tr> <tr> <td>TB2821A0</td> <td>EPDM 6X10 L=40MM PIPE</td> <td>4.000</td> <td>PC</td> </tr> <tr> <td>TB2994A0</td> <td>HOOD DETERGENT PIPE</td> <td>1.000</td> <td>PC</td> </tr> <tr> <td>TB3004A0</td> <td>TB2820A L=550mm EPDM BLACK PIPE</td> <td>2.000</td> <td>PC</td> </tr> <tr> <td>TB3005B0</td> <td>TB3132A L=550mm EPDM WHITE-BLUE PIPE</td> <td>1.000</td> <td>PC</td> </tr> <tr> <td>TB3440A0</td> <td>TB3132A L=1050mm EPDM WHITE-BLUE PIPE</td> <td>1.000</td> <td>PC</td> </tr> <tr> <td>TB3614A0</td> <td>TB3614A0</td> <td>1.000</td> <td>PC</td> </tr> <tr> <td>VI1220A1</td> <td>4,2x12 TCB SELF-TAPPING SCREW</td> <td>1.000</td> <td>PC</td> </tr> <tr> <td>VL1019A0</td> <td>VIBRATION DETERGENT PUMP</td> <td>1.000</td> <td>PC</td> </tr> <tr> <td>VL1047A1</td> <td>D6 PIPE HOLDER - D8 J.G. TERMINAL</td> <td>1.000</td> <td>PC</td> </tr> <tr> <td>VL1065A1</td> <td>1/4 MALE N.O. PRESSURE SWITCH</td> <td>1.000</td> <td>PC</td> </tr> <tr> <td>VL1102A1</td> <td>DETERGENT LINE FILTER + BARBED VNR 6 MM</td> <td>1.000</td> <td>PC</td> </tr> <tr> <td>VL1128A1</td> <td>D6 BARBED CHECK VALVE</td> <td>1.000</td> <td>PC</td> </tr> <tr> <td>VL1166A0</td> <td>BB6-AR6 L FITTING</td> <td>4.000</td> <td>PC</td> </tr> <tr> <td>VL1174C0</td> <td>D1.2 MM CALIBRATED NOZZLE</td> <td>1.000</td> <td>PC</td> </tr> <tr> <td>VL1186A0</td> <td>3 WAYS PLUS WASHING DISTRIBUTOR</td> <td>1.000</td> <td>PC</td> </tr> </tbody> </table>		Code	Description	Qty	UOM	RC1356A0	"STRAIGHT THREADED FEMALE END 8x1/4" BS	1.000	PC	RC1414A1	D11.5-12.5 SINGLE EAR HOSE CLAMP	1.000	PC	TB2821A0	EPDM 6X10 L=40MM PIPE	4.000	PC	TB2994A0	HOOD DETERGENT PIPE	1.000	PC	TB3004A0	TB2820A L=550mm EPDM BLACK PIPE	2.000	PC	TB3005B0	TB3132A L=550mm EPDM WHITE-BLUE PIPE	1.000	PC	TB3440A0	TB3132A L=1050mm EPDM WHITE-BLUE PIPE	1.000	PC	TB3614A0	TB3614A0	1.000	PC	VI1220A1	4,2x12 TCB SELF-TAPPING SCREW	1.000	PC	VL1019A0	VIBRATION DETERGENT PUMP	1.000	PC	VL1047A1	D6 PIPE HOLDER - D8 J.G. TERMINAL	1.000	PC	VL1065A1	1/4 MALE N.O. PRESSURE SWITCH	1.000	PC	VL1102A1	DETERGENT LINE FILTER + BARBED VNR 6 MM	1.000	PC	VL1128A1	D6 BARBED CHECK VALVE	1.000	PC	VL1166A0	BB6-AR6 L FITTING	4.000	PC	VL1174C0	D1.2 MM CALIBRATED NOZZLE	1.000	PC	VL1186A0	3 WAYS PLUS WASHING DISTRIBUTOR	1.000	PC
Code	Description	Qty	UOM																																																																											
RC1356A0	"STRAIGHT THREADED FEMALE END 8x1/4" BS	1.000	PC																																																																											
RC1414A1	D11.5-12.5 SINGLE EAR HOSE CLAMP	1.000	PC																																																																											
TB2821A0	EPDM 6X10 L=40MM PIPE	4.000	PC																																																																											
TB2994A0	HOOD DETERGENT PIPE	1.000	PC																																																																											
TB3004A0	TB2820A L=550mm EPDM BLACK PIPE	2.000	PC																																																																											
TB3005B0	TB3132A L=550mm EPDM WHITE-BLUE PIPE	1.000	PC																																																																											
TB3440A0	TB3132A L=1050mm EPDM WHITE-BLUE PIPE	1.000	PC																																																																											
TB3614A0	TB3614A0	1.000	PC																																																																											
VI1220A1	4,2x12 TCB SELF-TAPPING SCREW	1.000	PC																																																																											
VL1019A0	VIBRATION DETERGENT PUMP	1.000	PC																																																																											
VL1047A1	D6 PIPE HOLDER - D8 J.G. TERMINAL	1.000	PC																																																																											
VL1065A1	1/4 MALE N.O. PRESSURE SWITCH	1.000	PC																																																																											
VL1102A1	DETERGENT LINE FILTER + BARBED VNR 6 MM	1.000	PC																																																																											
VL1128A1	D6 BARBED CHECK VALVE	1.000	PC																																																																											
VL1166A0	BB6-AR6 L FITTING	4.000	PC																																																																											
VL1174C0	D1.2 MM CALIBRATED NOZZLE	1.000	PC																																																																											
VL1186A0	3 WAYS PLUS WASHING DISTRIBUTOR	1.000	PC																																																																											

COMPONENT			SPARE PART																																																							
Code	Description	Image	Code	Description	Kit components																																																					
VL1190A	PLUS WASHING SYSTEM INLET DISTRIBUTOR		KVL1184A	2 ROTOR ARMS PLUS EU CLEANING SYSTEM KIT	<table border="1"> <thead> <tr> <th>Code</th> <th>Description</th> <th>Qty</th> <th>UOM</th> </tr> </thead> <tbody> <tr> <td>VL1190A0</td> <td>PLUS WASHING SYSTEM INLET DISTRIBUTOR</td> <td>1.000</td> <td>PC</td> </tr> <tr> <td>VL1214A0</td> <td>BAYONET - 6mm BARBED NRV VALVE</td> <td>1.000</td> <td>PC</td> </tr> <tr> <td>VM1605A0</td> <td>CLIP TWIST LOCK DIAM. 10,2-12,7 MM</td> <td>3.000</td> <td>PC</td> </tr> <tr> <td>VM2172A0</td> <td>LOCKING CLIP FOR PUMP WITH CIRCUIT</td> <td>5.000</td> <td>PC</td> </tr> </tbody> </table>	Code	Description	Qty	UOM	VL1190A0	PLUS WASHING SYSTEM INLET DISTRIBUTOR	1.000	PC	VL1214A0	BAYONET - 6mm BARBED NRV VALVE	1.000	PC	VM1605A0	CLIP TWIST LOCK DIAM. 10,2-12,7 MM	3.000	PC	VM2172A0	LOCKING CLIP FOR PUMP WITH CIRCUIT	5.000	PC																																	
			Code	Description	Qty	UOM																																																				
VL1190A0	PLUS WASHING SYSTEM INLET DISTRIBUTOR	1.000	PC																																																							
VL1214A0	BAYONET - 6mm BARBED NRV VALVE	1.000	PC																																																							
VM1605A0	CLIP TWIST LOCK DIAM. 10,2-12,7 MM	3.000	PC																																																							
VM2172A0	LOCKING CLIP FOR PUMP WITH CIRCUIT	5.000	PC																																																							
KVL1183A	1 ROTOR ARM PLUS CLEANING SYSTEM KIT	<table border="1"> <thead> <tr> <th>Code</th> <th>Description</th> <th>Qty</th> <th>UOM</th> </tr> </thead> <tbody> <tr> <td>0H2354A1</td> <td>XEVC-XEVL PLUS WASHING CIRCUIT PLAT</td> <td>1.000</td> <td>PC</td> </tr> <tr> <td>EL1440A0</td> <td>WATER SELF CLEANING VALVE</td> <td>3.000</td> <td>PC</td> </tr> <tr> <td>GN1526A0</td> <td>INT. D.=6.9 TH=1.8 O-RIN</td> <td>7.000</td> <td>PC</td> </tr> <tr> <td>RC1018A0</td> <td>ZINC PLATED D12 ELASTIC CLAMP</td> <td>1.000</td> <td>PC</td> </tr> <tr> <td>RC1019A0</td> <td>D=10 ELASTIC CLAMP</td> <td>12.000</td> <td>PC</td> </tr> <tr> <td>RC1130A0</td> <td>130x2.6 CLAM</td> <td>1.000</td> <td>PC</td> </tr> <tr> <td>RC1131A0</td> <td>200x2.6 BLACK CLAMP</td> <td>2.000</td> <td>PC</td> </tr> <tr> <td>RC1242A0</td> <td>D=10 CLOSED CAP</td> <td>2.000</td> <td>PC</td> </tr> <tr> <td>RC1356A0</td> <td>"STRAIGHT THREADED FEMALE END 8x1/4" BS</td> <td>1.000</td> <td>PC</td> </tr> <tr> <td>RC1414A1</td> <td>D11.5-12.5 SINGLE EAR HOSE CLAMP</td> <td>1.000</td> <td>PC</td> </tr> <tr> <td>TB2821A0</td> <td>EPDM 6X10 L=40MM PIPE</td> <td>4.000</td> <td>PC</td> </tr> <tr> <td>TB3004A0</td> <td>TB2820A L=550mm EPDM BLACK PIPE</td> <td>1.000</td> <td>PC</td> </tr> <tr> <td>TB3005B0</td> <td>TB3132A L=550mm EPDM WHITE-BLUE PIPE</td> <td>1.000</td> <td>PC</td> </tr> </tbody> </table>	Code	Description	Qty	UOM	0H2354A1	XEVC-XEVL PLUS WASHING CIRCUIT PLAT	1.000	PC	EL1440A0	WATER SELF CLEANING VALVE	3.000	PC	GN1526A0	INT. D.=6.9 TH=1.8 O-RIN	7.000	PC	RC1018A0	ZINC PLATED D12 ELASTIC CLAMP	1.000	PC	RC1019A0	D=10 ELASTIC CLAMP	12.000	PC	RC1130A0	130x2.6 CLAM	1.000	PC	RC1131A0	200x2.6 BLACK CLAMP	2.000	PC	RC1242A0	D=10 CLOSED CAP	2.000	PC	RC1356A0	"STRAIGHT THREADED FEMALE END 8x1/4" BS	1.000	PC	RC1414A1	D11.5-12.5 SINGLE EAR HOSE CLAMP	1.000	PC	TB2821A0	EPDM 6X10 L=40MM PIPE	4.000	PC	TB3004A0	TB2820A L=550mm EPDM BLACK PIPE	1.000	PC	TB3005B0	TB3132A L=550mm EPDM WHITE-BLUE PIPE	1.000	PC
Code	Description	Qty	UOM																																																							
0H2354A1	XEVC-XEVL PLUS WASHING CIRCUIT PLAT	1.000	PC																																																							
EL1440A0	WATER SELF CLEANING VALVE	3.000	PC																																																							
GN1526A0	INT. D.=6.9 TH=1.8 O-RIN	7.000	PC																																																							
RC1018A0	ZINC PLATED D12 ELASTIC CLAMP	1.000	PC																																																							
RC1019A0	D=10 ELASTIC CLAMP	12.000	PC																																																							
RC1130A0	130x2.6 CLAM	1.000	PC																																																							
RC1131A0	200x2.6 BLACK CLAMP	2.000	PC																																																							
RC1242A0	D=10 CLOSED CAP	2.000	PC																																																							
RC1356A0	"STRAIGHT THREADED FEMALE END 8x1/4" BS	1.000	PC																																																							
RC1414A1	D11.5-12.5 SINGLE EAR HOSE CLAMP	1.000	PC																																																							
TB2821A0	EPDM 6X10 L=40MM PIPE	4.000	PC																																																							
TB3004A0	TB2820A L=550mm EPDM BLACK PIPE	1.000	PC																																																							
TB3005B0	TB3132A L=550mm EPDM WHITE-BLUE PIPE	1.000	PC																																																							



COMPONENT			SPARE PART																																																																																													
Code	Description	Image	Code	Description	Kit components																																																																																											
VL1190A	PLUS WASHING SYSTEM INLET DISTRIBUTOR		KVL1183A	1 ROTOR ARM PLUS CLEANING SYSTEM KIT	<table border="1"> <thead> <tr> <th>Code</th> <th>Description</th> <th>Qty</th> <th>UOM</th> </tr> </thead> <tbody> <tr> <td>TB3225B0</td> <td>TB2820A-TAN K-WASHYNG SYS CONNECTION</td> <td>1.000</td> <td>PC</td> </tr> <tr> <td>TB3252A0</td> <td>TB3252A0</td> <td>1.000</td> <td>PC</td> </tr> <tr> <td>TB3614A0</td> <td>TB3614A0</td> <td>1.000</td> <td>PC</td> </tr> <tr> <td>VI1220A1</td> <td>4,2x12 TCB SELF-TAPPIN G SCREW</td> <td>1.000</td> <td>PC</td> </tr> <tr> <td>VL1019A0</td> <td>VIBRATION DETERGENT PUMP</td> <td>1.000</td> <td>PC</td> </tr> <tr> <td>VL1047A1</td> <td>D6 PIPE HOLDER - D8 J.G. TERMINAL</td> <td>1.000</td> <td>PC</td> </tr> <tr> <td>VL1102A1</td> <td>DETERGENT LINE FILTER + BARBED VNR 6 MM</td> <td>1.000</td> <td>PC</td> </tr> <tr> <td>VL1128A1</td> <td>D6 BARBED CHECK VALVE</td> <td>1.000</td> <td>PC</td> </tr> <tr> <td>VL1166A0</td> <td>BB6-AR6 L FITTING</td> <td>3.000</td> <td>PC</td> </tr> <tr> <td>VL1174C0</td> <td>D1.2 MM CALIBRATED NOZZLE</td> <td>1.000</td> <td>PC</td> </tr> <tr> <td>VL1185A0</td> <td>2 WAYS PLUS WASHING DISTRIBUTOR</td> <td>1.000</td> <td>PC</td> </tr> <tr> <td>VL1190A0</td> <td>PLUS WASHING SYSTEM INLET DISTRIBUTOR</td> <td>1.000</td> <td>PC</td> </tr> <tr> <td>VL1214A0</td> <td>BAYONET - 6mm BARBED NRV VALVE</td> <td>1.000</td> <td>PC</td> </tr> <tr> <td>VL1398A0</td> <td>1/4 M N.O. CIL PRESSURE SWITCH</td> <td>1.000</td> <td>PC</td> </tr> <tr> <td>VM1605A0</td> <td>CLIP TWIST LOCK DIAM. 10,2-12,7 MM</td> <td>3.000</td> <td>PC</td> </tr> <tr> <td>VM2172A0</td> <td>LOCKING CLIP FOR PUMP WITH CIRCUIT</td> <td>4.000</td> <td>PC</td> </tr> </tbody> </table>	Code	Description	Qty	UOM	TB3225B0	TB2820A-TAN K-WASHYNG SYS CONNECTION	1.000	PC	TB3252A0	TB3252A0	1.000	PC	TB3614A0	TB3614A0	1.000	PC	VI1220A1	4,2x12 TCB SELF-TAPPIN G SCREW	1.000	PC	VL1019A0	VIBRATION DETERGENT PUMP	1.000	PC	VL1047A1	D6 PIPE HOLDER - D8 J.G. TERMINAL	1.000	PC	VL1102A1	DETERGENT LINE FILTER + BARBED VNR 6 MM	1.000	PC	VL1128A1	D6 BARBED CHECK VALVE	1.000	PC	VL1166A0	BB6-AR6 L FITTING	3.000	PC	VL1174C0	D1.2 MM CALIBRATED NOZZLE	1.000	PC	VL1185A0	2 WAYS PLUS WASHING DISTRIBUTOR	1.000	PC	VL1190A0	PLUS WASHING SYSTEM INLET DISTRIBUTOR	1.000	PC	VL1214A0	BAYONET - 6mm BARBED NRV VALVE	1.000	PC	VL1398A0	1/4 M N.O. CIL PRESSURE SWITCH	1.000	PC	VM1605A0	CLIP TWIST LOCK DIAM. 10,2-12,7 MM	3.000	PC	VM2172A0	LOCKING CLIP FOR PUMP WITH CIRCUIT	4.000	PC	KVL0684A	>12/2019 2-3ROTOR ARM PLUS WASH PUMP KIT	<table border="1"> <thead> <tr> <th>Code</th> <th>Description</th> <th>Qty</th> <th>UOM</th> </tr> </thead> <tbody> <tr> <td>GN1526A0</td> <td>INT. D.=6.9 TH=1.8 O-RIN</td> <td>3.000</td> <td>PC</td> </tr> <tr> <td>RC1019A0</td> <td>D=10 ELASTIC CLAMP</td> <td>4.000</td> <td>PC</td> </tr> <tr> <td>RC1130A0</td> <td>130x2,6 CLAM</td> <td>1.000</td> <td>PC</td> </tr> <tr> <td>RC1131A0</td> <td>200x2,6 BLACK CLAMP</td> <td>3.000</td> <td>PC</td> </tr> </tbody> </table>	Code	Description	Qty	UOM	GN1526A0	INT. D.=6.9 TH=1.8 O-RIN	3.000	PC	RC1019A0	D=10 ELASTIC CLAMP	4.000	PC	RC1130A0	130x2,6 CLAM	1.000	PC	RC1131A0	200x2,6 BLACK CLAMP	3.000	PC
			Code	Description	Qty	UOM																																																																																										
TB3225B0	TB2820A-TAN K-WASHYNG SYS CONNECTION	1.000	PC																																																																																													
TB3252A0	TB3252A0	1.000	PC																																																																																													
TB3614A0	TB3614A0	1.000	PC																																																																																													
VI1220A1	4,2x12 TCB SELF-TAPPIN G SCREW	1.000	PC																																																																																													
VL1019A0	VIBRATION DETERGENT PUMP	1.000	PC																																																																																													
VL1047A1	D6 PIPE HOLDER - D8 J.G. TERMINAL	1.000	PC																																																																																													
VL1102A1	DETERGENT LINE FILTER + BARBED VNR 6 MM	1.000	PC																																																																																													
VL1128A1	D6 BARBED CHECK VALVE	1.000	PC																																																																																													
VL1166A0	BB6-AR6 L FITTING	3.000	PC																																																																																													
VL1174C0	D1.2 MM CALIBRATED NOZZLE	1.000	PC																																																																																													
VL1185A0	2 WAYS PLUS WASHING DISTRIBUTOR	1.000	PC																																																																																													
VL1190A0	PLUS WASHING SYSTEM INLET DISTRIBUTOR	1.000	PC																																																																																													
VL1214A0	BAYONET - 6mm BARBED NRV VALVE	1.000	PC																																																																																													
VL1398A0	1/4 M N.O. CIL PRESSURE SWITCH	1.000	PC																																																																																													
VM1605A0	CLIP TWIST LOCK DIAM. 10,2-12,7 MM	3.000	PC																																																																																													
VM2172A0	LOCKING CLIP FOR PUMP WITH CIRCUIT	4.000	PC																																																																																													
Code	Description	Qty	UOM																																																																																													
GN1526A0	INT. D.=6.9 TH=1.8 O-RIN	3.000	PC																																																																																													
RC1019A0	D=10 ELASTIC CLAMP	4.000	PC																																																																																													
RC1130A0	130x2,6 CLAM	1.000	PC																																																																																													
RC1131A0	200x2,6 BLACK CLAMP	3.000	PC																																																																																													



COMPONENT			SPARE PART																																																			
Code	Description	Image	Code	Description	Kit components																																																	
VL1190A	PLUS WASHING SYSTEM INLET DISTRIBUTOR		KVL0684A	>12/2019 2-3ROTOR ARM PLUS WASH PUMP KIT	<table border="1"> <thead> <tr> <th>Code</th> <th>Description</th> <th>Qty</th> <th>UOM</th> </tr> </thead> <tbody> <tr> <td>RC1242A0</td> <td>D=10 CLOSED CAP</td> <td>2.000</td> <td>PC</td> </tr> <tr> <td>TB2821A0</td> <td>EPDM 6X10 L=40MM PIPE</td> <td>3.000</td> <td>PC</td> </tr> <tr> <td>VL1019A0</td> <td>VIBRATION DETERGENT PUMP</td> <td>1.000</td> <td>PC</td> </tr> <tr> <td>VL1128A1</td> <td>D6 BARBED CHECK VALVE</td> <td>1.000</td> <td>PC</td> </tr> <tr> <td>VL1174C0</td> <td>D1.2 MM CALIBRATED NOZZLE</td> <td>1.000</td> <td>PC</td> </tr> <tr> <td>VL1186A0</td> <td>3 WAYS PLUS WASHING DISTRIBUTOR</td> <td>1.000</td> <td>PC</td> </tr> <tr> <td>VL1190A0</td> <td>PLUS WASHING SYSTEM INLET DISTRIBUTOR</td> <td>1.000</td> <td>PC</td> </tr> <tr> <td>VM2172A0</td> <td>LOCKING CLIP FOR PUMP WITH CIRCUIT</td> <td>1.000</td> <td>PC</td> </tr> </tbody> </table>	Code	Description	Qty	UOM	RC1242A0	D=10 CLOSED CAP	2.000	PC	TB2821A0	EPDM 6X10 L=40MM PIPE	3.000	PC	VL1019A0	VIBRATION DETERGENT PUMP	1.000	PC	VL1128A1	D6 BARBED CHECK VALVE	1.000	PC	VL1174C0	D1.2 MM CALIBRATED NOZZLE	1.000	PC	VL1186A0	3 WAYS PLUS WASHING DISTRIBUTOR	1.000	PC	VL1190A0	PLUS WASHING SYSTEM INLET DISTRIBUTOR	1.000	PC	VM2172A0	LOCKING CLIP FOR PUMP WITH CIRCUIT	1.000	PC													
			Code	Description	Qty	UOM																																																
RC1242A0	D=10 CLOSED CAP	2.000	PC																																																			
TB2821A0	EPDM 6X10 L=40MM PIPE	3.000	PC																																																			
VL1019A0	VIBRATION DETERGENT PUMP	1.000	PC																																																			
VL1128A1	D6 BARBED CHECK VALVE	1.000	PC																																																			
VL1174C0	D1.2 MM CALIBRATED NOZZLE	1.000	PC																																																			
VL1186A0	3 WAYS PLUS WASHING DISTRIBUTOR	1.000	PC																																																			
VL1190A0	PLUS WASHING SYSTEM INLET DISTRIBUTOR	1.000	PC																																																			
VM2172A0	LOCKING CLIP FOR PUMP WITH CIRCUIT	1.000	PC																																																			
KVL0683A	>12/2019 1 ROTOR ARM PLUS WASH PUMP KIT	<table border="1"> <thead> <tr> <th>Code</th> <th>Description</th> <th>Qty</th> <th>UOM</th> </tr> </thead> <tbody> <tr> <td>GN1526A0</td> <td>INT. D.=6.9 TH=1.8 O-RIN</td> <td>2.000</td> <td>PC</td> </tr> <tr> <td>RC1019A0</td> <td>D=10 ELASTIC CLAMP</td> <td>4.000</td> <td>PC</td> </tr> <tr> <td>RC1130A0</td> <td>130x2.6 CLAMP</td> <td>1.000</td> <td>PC</td> </tr> <tr> <td>RC1131A0</td> <td>200x2.6 BLACK CLAMP</td> <td>2.000</td> <td>PC</td> </tr> <tr> <td>RC1242A0</td> <td>D=10 CLOSED CAP</td> <td>2.000</td> <td>PC</td> </tr> <tr> <td>TB2821A0</td> <td>EPDM 6X10 L=40MM PIPE</td> <td>3.000</td> <td>PC</td> </tr> <tr> <td>VL1019A0</td> <td>VIBRATION DETERGENT PUMP</td> <td>1.000</td> <td>PC</td> </tr> <tr> <td>VL1128A1</td> <td>D6 BARBED CHECK VALVE</td> <td>1.000</td> <td>PC</td> </tr> <tr> <td>VL1174C0</td> <td>D1.2 MM CALIBRATED NOZZLE</td> <td>1.000</td> <td>PC</td> </tr> <tr> <td>VL1185A0</td> <td>2 WAYS PLUS WASHING DISTRIBUTOR</td> <td>1.000</td> <td>PC</td> </tr> <tr> <td>VL1190A0</td> <td>PLUS WASHING SYSTEM INLET DISTRIBUTOR</td> <td>1.000</td> <td>PC</td> </tr> <tr> <td>VM2172A0</td> <td>LOCKING CLIP FOR PUMP WITH CIRCUIT</td> <td>1.000</td> <td>PC</td> </tr> </tbody> </table>	Code	Description	Qty	UOM	GN1526A0	INT. D.=6.9 TH=1.8 O-RIN	2.000	PC	RC1019A0	D=10 ELASTIC CLAMP	4.000	PC	RC1130A0	130x2.6 CLAMP	1.000	PC	RC1131A0	200x2.6 BLACK CLAMP	2.000	PC	RC1242A0	D=10 CLOSED CAP	2.000	PC	TB2821A0	EPDM 6X10 L=40MM PIPE	3.000	PC	VL1019A0	VIBRATION DETERGENT PUMP	1.000	PC	VL1128A1	D6 BARBED CHECK VALVE	1.000	PC	VL1174C0	D1.2 MM CALIBRATED NOZZLE	1.000	PC	VL1185A0	2 WAYS PLUS WASHING DISTRIBUTOR	1.000	PC	VL1190A0	PLUS WASHING SYSTEM INLET DISTRIBUTOR	1.000	PC	VM2172A0	LOCKING CLIP FOR PUMP WITH CIRCUIT	1.000	PC
Code	Description	Qty	UOM																																																			
GN1526A0	INT. D.=6.9 TH=1.8 O-RIN	2.000	PC																																																			
RC1019A0	D=10 ELASTIC CLAMP	4.000	PC																																																			
RC1130A0	130x2.6 CLAMP	1.000	PC																																																			
RC1131A0	200x2.6 BLACK CLAMP	2.000	PC																																																			
RC1242A0	D=10 CLOSED CAP	2.000	PC																																																			
TB2821A0	EPDM 6X10 L=40MM PIPE	3.000	PC																																																			
VL1019A0	VIBRATION DETERGENT PUMP	1.000	PC																																																			
VL1128A1	D6 BARBED CHECK VALVE	1.000	PC																																																			
VL1174C0	D1.2 MM CALIBRATED NOZZLE	1.000	PC																																																			
VL1185A0	2 WAYS PLUS WASHING DISTRIBUTOR	1.000	PC																																																			
VL1190A0	PLUS WASHING SYSTEM INLET DISTRIBUTOR	1.000	PC																																																			
VM2172A0	LOCKING CLIP FOR PUMP WITH CIRCUIT	1.000	PC																																																			



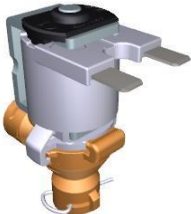

COMPONENT			SPARE PART																																		
Code	Description	Image	Code	Description	Kit components																																
VL1214A	BAYONET - 6mm BARBED NRV VALVE		KVL1214A	6mm BARBED-BAYONET NRV VALVE KIT	<table border="1"> <thead> <tr> <th>Code</th> <th>Description</th> <th>Qty</th> <th>UOM</th> </tr> </thead> <tbody> <tr> <td>RC1019A0</td> <td>D=10 ELASTIC CLAMP</td> <td>2.000</td> <td>PC</td> </tr> <tr> <td>TB2820A0</td> <td>6X10 EPDM PIPE FOR WASHING SYSTEM</td> <td>0.100</td> <td>M</td> </tr> <tr> <td>VL1214A0</td> <td>BAYONET - 6mm BARBED NRV VALVE</td> <td>1.000</td> <td>PC</td> </tr> </tbody> </table>	Code	Description	Qty	UOM	RC1019A0	D=10 ELASTIC CLAMP	2.000	PC	TB2820A0	6X10 EPDM PIPE FOR WASHING SYSTEM	0.100	M	VL1214A0	BAYONET - 6mm BARBED NRV VALVE	1.000	PC																
Code	Description	Qty	UOM																																		
RC1019A0	D=10 ELASTIC CLAMP	2.000	PC																																		
TB2820A0	6X10 EPDM PIPE FOR WASHING SYSTEM	0.100	M																																		
VL1214A0	BAYONET - 6mm BARBED NRV VALVE	1.000	PC																																		
VL1398A	1/4 M N.O. CIL PRESSURE SWITCH		KVL1065A	1/4 M N.O. CIL. PRESSURE SWITCH KIT	<table border="1"> <thead> <tr> <th>Code</th> <th>Description</th> <th>Qty</th> <th>UOM</th> </tr> </thead> <tbody> <tr> <td>VL1065A1</td> <td>1/4 MALE N.O. PRESSURE SWITCH</td> <td>1.000</td> <td>PC</td> </tr> </tbody> </table>	Code	Description	Qty	UOM	VL1065A1	1/4 MALE N.O. PRESSURE SWITCH	1.000	PC																								
Code	Description	Qty	UOM																																		
VL1065A1	1/4 MALE N.O. PRESSURE SWITCH	1.000	PC																																		
VM2172A	LOCKING CLIP FOR PUMP WITH CIRCUI		VM2172A0	LOCKING CLIP FOR PUMP WITH CIRCUI																																	
EL1440A	WATER SELF CLEANING VALVE		KVL2618A	2 ROTOR ARMS ONE CLEANING SYSTEM KIT	<table border="1"> <thead> <tr> <th>Code</th> <th>Description</th> <th>Qty</th> <th>UOM</th> </tr> </thead> <tbody> <tr> <td>0H2202A1</td> <td>ONE WASHING WITH STEAM VALVE SUPPORT</td> <td>2.000</td> <td>PC</td> </tr> <tr> <td>CE1030A0</td> <td>FEMALE FASTON COVER 6.3X0.8 0.5-1mmq</td> <td>4.000</td> <td>PC</td> </tr> <tr> <td>CE1395A0</td> <td>6,3 X 0,8 MALE FASTON</td> <td>2.000</td> <td>PC</td> </tr> <tr> <td>CE1545A0</td> <td>BLUE UNIP AWG18 ST.3135 WIRE</td> <td>2.000</td> <td>M</td> </tr> <tr> <td>CE1570A0</td> <td>WHITE UNIP AWG18 ST.3135 WIRE</td> <td>2.000</td> <td>M</td> </tr> <tr> <td>CE1660A0</td> <td>6,3x0,8 FEMALE FASTON COVER</td> <td>4.000</td> <td>PC</td> </tr> <tr> <td>CE1661A0</td> <td>MALE FASTON COVER 6,3x0,8</td> <td>2.000</td> <td>PC</td> </tr> </tbody> </table>	Code	Description	Qty	UOM	0H2202A1	ONE WASHING WITH STEAM VALVE SUPPORT	2.000	PC	CE1030A0	FEMALE FASTON COVER 6.3X0.8 0.5-1mmq	4.000	PC	CE1395A0	6,3 X 0,8 MALE FASTON	2.000	PC	CE1545A0	BLUE UNIP AWG18 ST.3135 WIRE	2.000	M	CE1570A0	WHITE UNIP AWG18 ST.3135 WIRE	2.000	M	CE1660A0	6,3x0,8 FEMALE FASTON COVER	4.000	PC	CE1661A0	MALE FASTON COVER 6,3x0,8	2.000	PC
Code	Description	Qty	UOM																																		
0H2202A1	ONE WASHING WITH STEAM VALVE SUPPORT	2.000	PC																																		
CE1030A0	FEMALE FASTON COVER 6.3X0.8 0.5-1mmq	4.000	PC																																		
CE1395A0	6,3 X 0,8 MALE FASTON	2.000	PC																																		
CE1545A0	BLUE UNIP AWG18 ST.3135 WIRE	2.000	M																																		
CE1570A0	WHITE UNIP AWG18 ST.3135 WIRE	2.000	M																																		
CE1660A0	6,3x0,8 FEMALE FASTON COVER	4.000	PC																																		
CE1661A0	MALE FASTON COVER 6,3x0,8	2.000	PC																																		



COMPONENT			SPARE PART																																																																														
Code	Description	Image	Code	Description	Kit components																																																																												
EL1440A	WATER SELF CLEANING VALVE		KVL2618A	2 ROTOR ARMS ONE CLEANING SYSTEM KIT	<table border="1"> <thead> <tr> <th>Code</th> <th>Description</th> <th>Qty</th> <th>UOM</th> </tr> </thead> <tbody> <tr> <td>EL1020A1</td> <td>D8 INTERMEDIAT E T-SHAPED FITTING</td> <td>1.000</td> <td>PC</td> </tr> <tr> <td>EL1440A0</td> <td>WATER SELF CLEANING VALVE</td> <td>2.000</td> <td>PC</td> </tr> <tr> <td>GN1526A0</td> <td>INT. D.=6.9 TH=1.8 O-RIN</td> <td>6.000</td> <td>PC</td> </tr> <tr> <td>RC1018A0</td> <td>ZINC PLATED D12 ELASTIC CLAMP</td> <td>2.000</td> <td>PC</td> </tr> <tr> <td>RC1019A0</td> <td>D=10 ELASTIC CLAMP</td> <td>28.000</td> <td>PC</td> </tr> <tr> <td>RC1130A0</td> <td>130x2,6 CLAM</td> <td>4.000</td> <td>PC</td> </tr> <tr> <td>RC1242A0</td> <td>D=10 CLOSED CAP</td> <td>4.000</td> <td>PC</td> </tr> <tr> <td>RC1414A1</td> <td>D11,5-12,5 SINGLE EAR HOSE CLAMP</td> <td>5.000</td> <td>PC</td> </tr> <tr> <td>TB2821A0</td> <td>EPDM 6X10 L=40MM PIPE</td> <td>12.000</td> <td>PC</td> </tr> <tr> <td>TB3004A0</td> <td>TB2820A L=550mm EPDM BLACK PIPE</td> <td>2.000</td> <td>PC</td> </tr> <tr> <td>TB3009B0</td> <td>TB3132A-ONE OVEN WASHING INLET</td> <td>2.000</td> <td>PC</td> </tr> <tr> <td>TB3225B0</td> <td>TB2820A-TAN K-WASHYNG SYS CONNECTION</td> <td>2.000</td> <td>PC</td> </tr> <tr> <td>VI1220A1</td> <td>4,2x12 TCB SELF-TAPPIN G SCREW</td> <td>2.000</td> <td>PC</td> </tr> <tr> <td>VL1019A0</td> <td>VIBRATION DETERGENT PUMP</td> <td>2.000</td> <td>PC</td> </tr> <tr> <td>VL1047A1</td> <td>D6 PIPE HOLDER - D8 J.G. TERMINAL</td> <td>2.000</td> <td>PC</td> </tr> <tr> <td>VL1054B0</td> <td>ONE WASHING SYS INLET DISTRIBUTOR</td> <td>2.000</td> <td>PC</td> </tr> <tr> <td>VL1102A1</td> <td>DETERGENT LINE FILTER + BARBED VNR 6 MM</td> <td>2.000</td> <td>PC</td> </tr> <tr> <td>VL1127A1</td> <td>6mm BARBED T-SHAPED FITTING</td> <td>1.000</td> <td>PC</td> </tr> </tbody> </table>	Code	Description	Qty	UOM	EL1020A1	D8 INTERMEDIAT E T-SHAPED FITTING	1.000	PC	EL1440A0	WATER SELF CLEANING VALVE	2.000	PC	GN1526A0	INT. D.=6.9 TH=1.8 O-RIN	6.000	PC	RC1018A0	ZINC PLATED D12 ELASTIC CLAMP	2.000	PC	RC1019A0	D=10 ELASTIC CLAMP	28.000	PC	RC1130A0	130x2,6 CLAM	4.000	PC	RC1242A0	D=10 CLOSED CAP	4.000	PC	RC1414A1	D11,5-12,5 SINGLE EAR HOSE CLAMP	5.000	PC	TB2821A0	EPDM 6X10 L=40MM PIPE	12.000	PC	TB3004A0	TB2820A L=550mm EPDM BLACK PIPE	2.000	PC	TB3009B0	TB3132A-ONE OVEN WASHING INLET	2.000	PC	TB3225B0	TB2820A-TAN K-WASHYNG SYS CONNECTION	2.000	PC	VI1220A1	4,2x12 TCB SELF-TAPPIN G SCREW	2.000	PC	VL1019A0	VIBRATION DETERGENT PUMP	2.000	PC	VL1047A1	D6 PIPE HOLDER - D8 J.G. TERMINAL	2.000	PC	VL1054B0	ONE WASHING SYS INLET DISTRIBUTOR	2.000	PC	VL1102A1	DETERGENT LINE FILTER + BARBED VNR 6 MM	2.000	PC	VL1127A1	6mm BARBED T-SHAPED FITTING	1.000	PC
Code	Description	Qty	UOM																																																																														
EL1020A1	D8 INTERMEDIAT E T-SHAPED FITTING	1.000	PC																																																																														
EL1440A0	WATER SELF CLEANING VALVE	2.000	PC																																																																														
GN1526A0	INT. D.=6.9 TH=1.8 O-RIN	6.000	PC																																																																														
RC1018A0	ZINC PLATED D12 ELASTIC CLAMP	2.000	PC																																																																														
RC1019A0	D=10 ELASTIC CLAMP	28.000	PC																																																																														
RC1130A0	130x2,6 CLAM	4.000	PC																																																																														
RC1242A0	D=10 CLOSED CAP	4.000	PC																																																																														
RC1414A1	D11,5-12,5 SINGLE EAR HOSE CLAMP	5.000	PC																																																																														
TB2821A0	EPDM 6X10 L=40MM PIPE	12.000	PC																																																																														
TB3004A0	TB2820A L=550mm EPDM BLACK PIPE	2.000	PC																																																																														
TB3009B0	TB3132A-ONE OVEN WASHING INLET	2.000	PC																																																																														
TB3225B0	TB2820A-TAN K-WASHYNG SYS CONNECTION	2.000	PC																																																																														
VI1220A1	4,2x12 TCB SELF-TAPPIN G SCREW	2.000	PC																																																																														
VL1019A0	VIBRATION DETERGENT PUMP	2.000	PC																																																																														
VL1047A1	D6 PIPE HOLDER - D8 J.G. TERMINAL	2.000	PC																																																																														
VL1054B0	ONE WASHING SYS INLET DISTRIBUTOR	2.000	PC																																																																														
VL1102A1	DETERGENT LINE FILTER + BARBED VNR 6 MM	2.000	PC																																																																														
VL1127A1	6mm BARBED T-SHAPED FITTING	1.000	PC																																																																														



COMPONENT			SPARE PART																																																							
Code	Description	Image	Code	Description	Kit components																																																					
EL1440A	WATER SELF CLEANING VALVE		KVL2618A	2 ROTOR ARMS ONE CLEANING SYSTEM KIT	<table border="1"> <thead> <tr> <th>Code</th> <th>Description</th> <th>Qty</th> <th>UOM</th> </tr> </thead> <tbody> <tr> <td>VL1128A1</td> <td>D6 BARBED CHECK VALVE</td> <td>4.000</td> <td>PC</td> </tr> <tr> <td>VL1166A0</td> <td>BB6-AR6 L FITTING</td> <td>2.000</td> <td>PC</td> </tr> <tr> <td>VL1174C0</td> <td>D1.2 MM CALIBRATED NOZZLE</td> <td>2.000</td> <td>PC</td> </tr> <tr> <td>VL1191A0</td> <td>ONE WASHING DISTRIBUTOR OUTLETS KIT</td> <td>2.000</td> <td>PC</td> </tr> <tr> <td>VL1214A0</td> <td>BAYONET - 6mm BARBED NRV VALVE</td> <td>2.000</td> <td>PC</td> </tr> <tr> <td>VM2172A0</td> <td>LOCKING CLIP FOR PUMP WITH CIRCUIT</td> <td>4.000</td> <td>PC</td> </tr> </tbody> </table>	Code	Description	Qty	UOM	VL1128A1	D6 BARBED CHECK VALVE	4.000	PC	VL1166A0	BB6-AR6 L FITTING	2.000	PC	VL1174C0	D1.2 MM CALIBRATED NOZZLE	2.000	PC	VL1191A0	ONE WASHING DISTRIBUTOR OUTLETS KIT	2.000	PC	VL1214A0	BAYONET - 6mm BARBED NRV VALVE	2.000	PC	VM2172A0	LOCKING CLIP FOR PUMP WITH CIRCUIT	4.000	PC																									
			Code	Description	Qty	UOM																																																				
VL1128A1	D6 BARBED CHECK VALVE	4.000	PC																																																							
VL1166A0	BB6-AR6 L FITTING	2.000	PC																																																							
VL1174C0	D1.2 MM CALIBRATED NOZZLE	2.000	PC																																																							
VL1191A0	ONE WASHING DISTRIBUTOR OUTLETS KIT	2.000	PC																																																							
VL1214A0	BAYONET - 6mm BARBED NRV VALVE	2.000	PC																																																							
VM2172A0	LOCKING CLIP FOR PUMP WITH CIRCUIT	4.000	PC																																																							
KVL1222A	EUR 0311 ONE PLUS CLEANING SYSTEM KIT	<table border="1"> <thead> <tr> <th>Code</th> <th>Description</th> <th>Qty</th> <th>UOM</th> </tr> </thead> <tbody> <tr> <td>0H2486A0</td> <td>0311 WASHING CIRCUIT PLAT</td> <td>1.000</td> <td>PC</td> </tr> <tr> <td>EL1440A0</td> <td>WATER SELF CLEANING VALVE</td> <td>1.000</td> <td>PC</td> </tr> <tr> <td>GN1526A0</td> <td>INT. D.=6.9 TH=1.8 O-RIN</td> <td>3.000</td> <td>PC</td> </tr> <tr> <td>RC1019A0</td> <td>D=10 ELASTIC CLAMP</td> <td>12.000</td> <td>PC</td> </tr> <tr> <td>RC1242A0</td> <td>D=10 CLOSED CAP</td> <td>2.000</td> <td>PC</td> </tr> <tr> <td>RC1414A1</td> <td>D11.5-12.5 SINGLE EAR HOSE CLAMP</td> <td>1.000</td> <td>PC</td> </tr> <tr> <td>TB2821A0</td> <td>EPDM 6X10 L=40MM PIPE</td> <td>4.000</td> <td>PC</td> </tr> <tr> <td>TB3004A0</td> <td>TB2820A L=550mm EPDM BLACK PIPE</td> <td>1.000</td> <td>PC</td> </tr> <tr> <td>TB3009B0</td> <td>TB3132A-ONE OVEN WASHING INLET</td> <td>1.000</td> <td>PC</td> </tr> <tr> <td>TB3225B0</td> <td>TB2820A-TAN K-WASHYNG SYS CONNECTION</td> <td>1.000</td> <td>PC</td> </tr> <tr> <td>TB3614A0</td> <td>TB3614A0</td> <td>1.000</td> <td>PC</td> </tr> <tr> <td>VI1220A1</td> <td>4,2x12 TCB SELF-TAPPIN G SCREW</td> <td>4.000</td> <td>PC</td> </tr> <tr> <td>VI2070A0</td> <td>SHEETTRACS TCB+ 40x8 SELF-THREAD SCREW</td> <td>2.000</td> <td>PC</td> </tr> </tbody> </table>	Code	Description	Qty	UOM	0H2486A0	0311 WASHING CIRCUIT PLAT	1.000	PC	EL1440A0	WATER SELF CLEANING VALVE	1.000	PC	GN1526A0	INT. D.=6.9 TH=1.8 O-RIN	3.000	PC	RC1019A0	D=10 ELASTIC CLAMP	12.000	PC	RC1242A0	D=10 CLOSED CAP	2.000	PC	RC1414A1	D11.5-12.5 SINGLE EAR HOSE CLAMP	1.000	PC	TB2821A0	EPDM 6X10 L=40MM PIPE	4.000	PC	TB3004A0	TB2820A L=550mm EPDM BLACK PIPE	1.000	PC	TB3009B0	TB3132A-ONE OVEN WASHING INLET	1.000	PC	TB3225B0	TB2820A-TAN K-WASHYNG SYS CONNECTION	1.000	PC	TB3614A0	TB3614A0	1.000	PC	VI1220A1	4,2x12 TCB SELF-TAPPIN G SCREW	4.000	PC	VI2070A0	SHEETTRACS TCB+ 40x8 SELF-THREAD SCREW	2.000	PC
Code	Description	Qty	UOM																																																							
0H2486A0	0311 WASHING CIRCUIT PLAT	1.000	PC																																																							
EL1440A0	WATER SELF CLEANING VALVE	1.000	PC																																																							
GN1526A0	INT. D.=6.9 TH=1.8 O-RIN	3.000	PC																																																							
RC1019A0	D=10 ELASTIC CLAMP	12.000	PC																																																							
RC1242A0	D=10 CLOSED CAP	2.000	PC																																																							
RC1414A1	D11.5-12.5 SINGLE EAR HOSE CLAMP	1.000	PC																																																							
TB2821A0	EPDM 6X10 L=40MM PIPE	4.000	PC																																																							
TB3004A0	TB2820A L=550mm EPDM BLACK PIPE	1.000	PC																																																							
TB3009B0	TB3132A-ONE OVEN WASHING INLET	1.000	PC																																																							
TB3225B0	TB2820A-TAN K-WASHYNG SYS CONNECTION	1.000	PC																																																							
TB3614A0	TB3614A0	1.000	PC																																																							
VI1220A1	4,2x12 TCB SELF-TAPPIN G SCREW	4.000	PC																																																							
VI2070A0	SHEETTRACS TCB+ 40x8 SELF-THREAD SCREW	2.000	PC																																																							

COMPONENT			SPARE PART																																														
Code	Description	Image	Code	Description	Kit components																																												
EL1440A	WATER SELF CLEANING VALVE		KVL1222A	EUR 0311 ONE PLUS CLEANING SYSTEM KIT	<table border="1"> <thead> <tr> <th>Code</th> <th>Description</th> <th>Qty</th> <th>UOM</th> </tr> </thead> <tbody> <tr> <td>VL1019A0</td> <td>VIBRATION DETERGENT PUMP</td> <td>1.000</td> <td>PC</td> </tr> <tr> <td>VL1047A1</td> <td>D6 PIPE HOLDER - D8 J.G. TERMINAL</td> <td>1.000</td> <td>PC</td> </tr> <tr> <td>VL1054B0</td> <td>ONE WASHING SYS INLET DISTRIBUTOR</td> <td>1.000</td> <td>PC</td> </tr> <tr> <td>VL1102A1</td> <td>DETERGENT LINE FILTER + BARBED VNR 6 MM</td> <td>1.000</td> <td>PC</td> </tr> <tr> <td>VL1128A1</td> <td>D6 BARBED CHECK VALVE</td> <td>1.000</td> <td>PC</td> </tr> <tr> <td>VL1166A0</td> <td>BB6-AR6 L FITTING</td> <td>1.000</td> <td>PC</td> </tr> <tr> <td>VL1174C0</td> <td>D1.2 MM CALIBRATED NOZZLE</td> <td>1.000</td> <td>PC</td> </tr> <tr> <td>VL1191A0</td> <td>ONE WASHING DISTRIBUTOR OUTLETS KIT</td> <td>1.000</td> <td>PC</td> </tr> <tr> <td>VL1214A0</td> <td>BAYONET - 6mm BARBED NRV VALVE</td> <td>1.000</td> <td>PC</td> </tr> <tr> <td>VM2172A0</td> <td>LOCKING CLIP FOR PUMP WITH CIRCUIT</td> <td>2.000</td> <td>PC</td> </tr> </tbody> </table>	Code	Description	Qty	UOM	VL1019A0	VIBRATION DETERGENT PUMP	1.000	PC	VL1047A1	D6 PIPE HOLDER - D8 J.G. TERMINAL	1.000	PC	VL1054B0	ONE WASHING SYS INLET DISTRIBUTOR	1.000	PC	VL1102A1	DETERGENT LINE FILTER + BARBED VNR 6 MM	1.000	PC	VL1128A1	D6 BARBED CHECK VALVE	1.000	PC	VL1166A0	BB6-AR6 L FITTING	1.000	PC	VL1174C0	D1.2 MM CALIBRATED NOZZLE	1.000	PC	VL1191A0	ONE WASHING DISTRIBUTOR OUTLETS KIT	1.000	PC	VL1214A0	BAYONET - 6mm BARBED NRV VALVE	1.000	PC	VM2172A0	LOCKING CLIP FOR PUMP WITH CIRCUIT	2.000	PC
			Code	Description	Qty	UOM																																											
VL1019A0	VIBRATION DETERGENT PUMP	1.000	PC																																														
VL1047A1	D6 PIPE HOLDER - D8 J.G. TERMINAL	1.000	PC																																														
VL1054B0	ONE WASHING SYS INLET DISTRIBUTOR	1.000	PC																																														
VL1102A1	DETERGENT LINE FILTER + BARBED VNR 6 MM	1.000	PC																																														
VL1128A1	D6 BARBED CHECK VALVE	1.000	PC																																														
VL1166A0	BB6-AR6 L FITTING	1.000	PC																																														
VL1174C0	D1.2 MM CALIBRATED NOZZLE	1.000	PC																																														
VL1191A0	ONE WASHING DISTRIBUTOR OUTLETS KIT	1.000	PC																																														
VL1214A0	BAYONET - 6mm BARBED NRV VALVE	1.000	PC																																														
VM2172A0	LOCKING CLIP FOR PUMP WITH CIRCUIT	2.000	PC																																														
KVL1212A	EUR COMPACT PLUS CLEANING SYSTEM KIT	<table border="1"> <thead> <tr> <th>Code</th> <th>Description</th> <th>Qty</th> <th>UOM</th> </tr> </thead> <tbody> <tr> <td>0H2428A2</td> <td>XECC PLUS WASHING CIRCUIT PLAT</td> <td>1.000</td> <td>PC</td> </tr> <tr> <td>EL1440A0</td> <td>WATER SELF CLEANING VALVE</td> <td>3.000</td> <td>PC</td> </tr> <tr> <td>GN1311A0</td> <td>RUBBER CABLE-PASSI NG De=25 Di=12 Th=6,5</td> <td>1.000</td> <td>PC</td> </tr> <tr> <td>GN1526A0</td> <td>INT. D.=6.9 TH=1.8 O-RIN</td> <td>7.000</td> <td>PC</td> </tr> <tr> <td>RC1018A0</td> <td>ZINC PLATED D12 ELASTIC CLAMP</td> <td>5.000</td> <td>PC</td> </tr> <tr> <td>RC1019A0</td> <td>D=10 ELASTIC CLAMP</td> <td>14.000</td> <td>PC</td> </tr> <tr> <td>RC1130A0</td> <td>130x2,6 CLAM</td> <td>1.000</td> <td>PC</td> </tr> <tr> <td>RC1131A0</td> <td>200x2,6 BLACK CLAMP</td> <td>1.000</td> <td>PC</td> </tr> <tr> <td>RC1242A0</td> <td>D=10 CLOSED CAP</td> <td>2.000</td> <td>PC</td> </tr> </tbody> </table>	Code	Description	Qty	UOM	0H2428A2	XECC PLUS WASHING CIRCUIT PLAT	1.000	PC	EL1440A0	WATER SELF CLEANING VALVE	3.000	PC	GN1311A0	RUBBER CABLE-PASSI NG De=25 Di=12 Th=6,5	1.000	PC	GN1526A0	INT. D.=6.9 TH=1.8 O-RIN	7.000	PC	RC1018A0	ZINC PLATED D12 ELASTIC CLAMP	5.000	PC	RC1019A0	D=10 ELASTIC CLAMP	14.000	PC	RC1130A0	130x2,6 CLAM	1.000	PC	RC1131A0	200x2,6 BLACK CLAMP	1.000	PC	RC1242A0	D=10 CLOSED CAP	2.000	PC							
Code	Description	Qty	UOM																																														
0H2428A2	XECC PLUS WASHING CIRCUIT PLAT	1.000	PC																																														
EL1440A0	WATER SELF CLEANING VALVE	3.000	PC																																														
GN1311A0	RUBBER CABLE-PASSI NG De=25 Di=12 Th=6,5	1.000	PC																																														
GN1526A0	INT. D.=6.9 TH=1.8 O-RIN	7.000	PC																																														
RC1018A0	ZINC PLATED D12 ELASTIC CLAMP	5.000	PC																																														
RC1019A0	D=10 ELASTIC CLAMP	14.000	PC																																														
RC1130A0	130x2,6 CLAM	1.000	PC																																														
RC1131A0	200x2,6 BLACK CLAMP	1.000	PC																																														
RC1242A0	D=10 CLOSED CAP	2.000	PC																																														



COMPONENT			SPARE PART																																																																														
Code	Description	Image	Code	Description	Kit components																																																																												
EL1440A	WATER SELF CLEANING VALVE		KVL1212A	EUR COMPACT PLUS CLEANING SYSTEM KIT	<table border="1"> <thead> <tr> <th>Code</th> <th>Description</th> <th>Qty</th> <th>UOM</th> </tr> </thead> <tbody> <tr> <td>RC1356A0</td> <td>"STRAIGHT THREADED FEMALE END 8x1/4" BS</td> <td>1.000</td> <td>PC</td> </tr> <tr> <td>RC1414A1</td> <td>D11.5-12.5 SINGLE EAR HOSE CLAMP</td> <td>4.000</td> <td>PC</td> </tr> <tr> <td>TB2821A0</td> <td>EPDM 6X10 L=40MM PIPE</td> <td>6.000</td> <td>PC</td> </tr> <tr> <td>TB3004A0</td> <td>TB2820A L=550mm EPDM BLACK PIPE</td> <td>2.000</td> <td>PC</td> </tr> <tr> <td>TB3005B0</td> <td>TB3132A L=550mm EPDM WHITE-BLUE PIPE</td> <td>1.000</td> <td>PC</td> </tr> <tr> <td>TB3252A0</td> <td>TB3252A0</td> <td>1.000</td> <td>PC</td> </tr> <tr> <td>TB3469A0</td> <td></td> <td>1.000</td> <td>PC</td> </tr> <tr> <td>VI1220A1</td> <td>4,2x12 TCB SELF-TAPPIN G SCREW</td> <td>3.000</td> <td>PC</td> </tr> <tr> <td>VL1019A0</td> <td>VIBRATION DETERGENT PUMP</td> <td>1.000</td> <td>PC</td> </tr> <tr> <td>VL1047A1</td> <td>D6 PIPE HOLDER - D6 J.G. TERMINAL</td> <td>1.000</td> <td>PC</td> </tr> <tr> <td>VL1054B0</td> <td>ONE WASHING SYS INLET DISTRIBUTOR</td> <td>1.000</td> <td>PC</td> </tr> <tr> <td>VL1065A1</td> <td>1/4 MALE N.O. PRESSURE SWITCH</td> <td>1.000</td> <td>PC</td> </tr> <tr> <td>VL1102A1</td> <td>DETERGENT LINE FILTER + BARBED VNR 6 MM</td> <td>1.000</td> <td>PC</td> </tr> <tr> <td>VL1127A1</td> <td>6mm BARBED T-SHAPED FITTING</td> <td>1.000</td> <td>PC</td> </tr> <tr> <td>VL1128A1</td> <td>D6 BARBED CHECK VALVE</td> <td>2.000</td> <td>PC</td> </tr> <tr> <td>VL1165A0</td> <td>BAM-BB6 STRAIGHT FITTING</td> <td>1.000</td> <td>PC</td> </tr> <tr> <td>VL1166A0</td> <td>BB6-AR6 L FITTING</td> <td>3.000</td> <td>PC</td> </tr> <tr> <td>VL1174C0</td> <td>D1.2 MM CALIBRATED NOZZLE</td> <td>1.000</td> <td>PC</td> </tr> </tbody> </table>	Code	Description	Qty	UOM	RC1356A0	"STRAIGHT THREADED FEMALE END 8x1/4" BS	1.000	PC	RC1414A1	D11.5-12.5 SINGLE EAR HOSE CLAMP	4.000	PC	TB2821A0	EPDM 6X10 L=40MM PIPE	6.000	PC	TB3004A0	TB2820A L=550mm EPDM BLACK PIPE	2.000	PC	TB3005B0	TB3132A L=550mm EPDM WHITE-BLUE PIPE	1.000	PC	TB3252A0	TB3252A0	1.000	PC	TB3469A0		1.000	PC	VI1220A1	4,2x12 TCB SELF-TAPPIN G SCREW	3.000	PC	VL1019A0	VIBRATION DETERGENT PUMP	1.000	PC	VL1047A1	D6 PIPE HOLDER - D6 J.G. TERMINAL	1.000	PC	VL1054B0	ONE WASHING SYS INLET DISTRIBUTOR	1.000	PC	VL1065A1	1/4 MALE N.O. PRESSURE SWITCH	1.000	PC	VL1102A1	DETERGENT LINE FILTER + BARBED VNR 6 MM	1.000	PC	VL1127A1	6mm BARBED T-SHAPED FITTING	1.000	PC	VL1128A1	D6 BARBED CHECK VALVE	2.000	PC	VL1165A0	BAM-BB6 STRAIGHT FITTING	1.000	PC	VL1166A0	BB6-AR6 L FITTING	3.000	PC	VL1174C0	D1.2 MM CALIBRATED NOZZLE	1.000	PC
Code	Description	Qty	UOM																																																																														
RC1356A0	"STRAIGHT THREADED FEMALE END 8x1/4" BS	1.000	PC																																																																														
RC1414A1	D11.5-12.5 SINGLE EAR HOSE CLAMP	4.000	PC																																																																														
TB2821A0	EPDM 6X10 L=40MM PIPE	6.000	PC																																																																														
TB3004A0	TB2820A L=550mm EPDM BLACK PIPE	2.000	PC																																																																														
TB3005B0	TB3132A L=550mm EPDM WHITE-BLUE PIPE	1.000	PC																																																																														
TB3252A0	TB3252A0	1.000	PC																																																																														
TB3469A0		1.000	PC																																																																														
VI1220A1	4,2x12 TCB SELF-TAPPIN G SCREW	3.000	PC																																																																														
VL1019A0	VIBRATION DETERGENT PUMP	1.000	PC																																																																														
VL1047A1	D6 PIPE HOLDER - D6 J.G. TERMINAL	1.000	PC																																																																														
VL1054B0	ONE WASHING SYS INLET DISTRIBUTOR	1.000	PC																																																																														
VL1065A1	1/4 MALE N.O. PRESSURE SWITCH	1.000	PC																																																																														
VL1102A1	DETERGENT LINE FILTER + BARBED VNR 6 MM	1.000	PC																																																																														
VL1127A1	6mm BARBED T-SHAPED FITTING	1.000	PC																																																																														
VL1128A1	D6 BARBED CHECK VALVE	2.000	PC																																																																														
VL1165A0	BAM-BB6 STRAIGHT FITTING	1.000	PC																																																																														
VL1166A0	BB6-AR6 L FITTING	3.000	PC																																																																														
VL1174C0	D1.2 MM CALIBRATED NOZZLE	1.000	PC																																																																														

COMPONENT			SPARE PART																																																																							
Code	Description	Image	Code	Description	Kit components																																																																					
EL1440A	WATER SELF CLEANING VALVE		KVL1212A	EUR COMPACT PLUS CLEANING SYSTEM KIT	<table border="1"> <thead> <tr> <th>Code</th> <th>Description</th> <th>Qty</th> <th>UOM</th> </tr> </thead> <tbody> <tr> <td>VL1185A0</td> <td>2 WAYS PLUS WASHING DISTRIBUTOR</td> <td>1.000</td> <td>PC</td> </tr> <tr> <td>VM2172A0</td> <td>LOCKING CLIP FOR PUMP WITH CIRCUIT</td> <td>3.000</td> <td>PC</td> </tr> </tbody> </table>	Code	Description	Qty	UOM	VL1185A0	2 WAYS PLUS WASHING DISTRIBUTOR	1.000	PC	VM2172A0	LOCKING CLIP FOR PUMP WITH CIRCUIT	3.000	PC																																																									
			Code	Description	Qty	UOM																																																																				
VL1185A0	2 WAYS PLUS WASHING DISTRIBUTOR	1.000	PC																																																																							
VM2172A0	LOCKING CLIP FOR PUMP WITH CIRCUIT	3.000	PC																																																																							
KVL1211A	ONE COMPACT AND 0523-EP WASH. SYSTEM KIT	<table border="1"> <thead> <tr> <th>Code</th> <th>Description</th> <th>Qty</th> <th>UOM</th> </tr> </thead> <tbody> <tr> <td>0H2427A0</td> <td>XECC WASHING CIRCUIT HOLDING PLATE</td> <td>1.000</td> <td>PC</td> </tr> <tr> <td>EL1440A0</td> <td>WATER SELF CLEANING VALVE</td> <td>1.000</td> <td>PC</td> </tr> <tr> <td>GN1526A0</td> <td>INT. D.=6.9 TH=1.8 O-RING</td> <td>3.000</td> <td>PC</td> </tr> <tr> <td>RC1018A0</td> <td>ZINC PLATED D12 ELASTIC CLAMP</td> <td>4.000</td> <td>PC</td> </tr> <tr> <td>RC1019A0</td> <td>D=10 ELASTIC CLAMP</td> <td>14.000</td> <td>PC</td> </tr> <tr> <td>RC1130A0</td> <td>130x2.6 CLAM</td> <td>1.000</td> <td>PC</td> </tr> <tr> <td>RC1242A0</td> <td>D=10 CLOSED CAP</td> <td>2.000</td> <td>PC</td> </tr> <tr> <td>RC1414A1</td> <td>D11.5-12.5 SINGLE EAR HOSE CLAMP</td> <td>4.000</td> <td>PC</td> </tr> <tr> <td>TB2821A0</td> <td>EPDM 6X10 L=40MM PIPE</td> <td>6.000</td> <td>PC</td> </tr> <tr> <td>TB3004A0</td> <td>TB2820A L=550mm EPDM BLACK PIPE</td> <td>1.000</td> <td>PC</td> </tr> <tr> <td>TB3252A0</td> <td>TB3252A0</td> <td>1.000</td> <td>PC</td> </tr> <tr> <td>TB3469A0</td> <td></td> <td>1.000</td> <td>PC</td> </tr> <tr> <td>VI1220A1</td> <td>4,2x12 TCB SELF-TAPPING SCREW</td> <td>4.000</td> <td>PC</td> </tr> <tr> <td>VL1019A0</td> <td>VIBRATION DETERGENT PUMP</td> <td>1.000</td> <td>PC</td> </tr> <tr> <td>VL1047A1</td> <td>D6 PIPE HOLDER - D8 J.G. TERMINAL</td> <td>1.000</td> <td>PC</td> </tr> <tr> <td>VL1054B0</td> <td>ONE WASHING SYS INLET DISTRIBUTOR</td> <td>1.000</td> <td>PC</td> </tr> <tr> <td>VL1102A1</td> <td>DETERGENT LINE FILTER + BARBED VNR 6 MM</td> <td>1.000</td> <td>PC</td> </tr> </tbody> </table>	Code	Description	Qty	UOM	0H2427A0	XECC WASHING CIRCUIT HOLDING PLATE	1.000	PC	EL1440A0	WATER SELF CLEANING VALVE	1.000	PC	GN1526A0	INT. D.=6.9 TH=1.8 O-RING	3.000	PC	RC1018A0	ZINC PLATED D12 ELASTIC CLAMP	4.000	PC	RC1019A0	D=10 ELASTIC CLAMP	14.000	PC	RC1130A0	130x2.6 CLAM	1.000	PC	RC1242A0	D=10 CLOSED CAP	2.000	PC	RC1414A1	D11.5-12.5 SINGLE EAR HOSE CLAMP	4.000	PC	TB2821A0	EPDM 6X10 L=40MM PIPE	6.000	PC	TB3004A0	TB2820A L=550mm EPDM BLACK PIPE	1.000	PC	TB3252A0	TB3252A0	1.000	PC	TB3469A0		1.000	PC	VI1220A1	4,2x12 TCB SELF-TAPPING SCREW	4.000	PC	VL1019A0	VIBRATION DETERGENT PUMP	1.000	PC	VL1047A1	D6 PIPE HOLDER - D8 J.G. TERMINAL	1.000	PC	VL1054B0	ONE WASHING SYS INLET DISTRIBUTOR	1.000	PC	VL1102A1	DETERGENT LINE FILTER + BARBED VNR 6 MM	1.000	PC
Code	Description	Qty	UOM																																																																							
0H2427A0	XECC WASHING CIRCUIT HOLDING PLATE	1.000	PC																																																																							
EL1440A0	WATER SELF CLEANING VALVE	1.000	PC																																																																							
GN1526A0	INT. D.=6.9 TH=1.8 O-RING	3.000	PC																																																																							
RC1018A0	ZINC PLATED D12 ELASTIC CLAMP	4.000	PC																																																																							
RC1019A0	D=10 ELASTIC CLAMP	14.000	PC																																																																							
RC1130A0	130x2.6 CLAM	1.000	PC																																																																							
RC1242A0	D=10 CLOSED CAP	2.000	PC																																																																							
RC1414A1	D11.5-12.5 SINGLE EAR HOSE CLAMP	4.000	PC																																																																							
TB2821A0	EPDM 6X10 L=40MM PIPE	6.000	PC																																																																							
TB3004A0	TB2820A L=550mm EPDM BLACK PIPE	1.000	PC																																																																							
TB3252A0	TB3252A0	1.000	PC																																																																							
TB3469A0		1.000	PC																																																																							
VI1220A1	4,2x12 TCB SELF-TAPPING SCREW	4.000	PC																																																																							
VL1019A0	VIBRATION DETERGENT PUMP	1.000	PC																																																																							
VL1047A1	D6 PIPE HOLDER - D8 J.G. TERMINAL	1.000	PC																																																																							
VL1054B0	ONE WASHING SYS INLET DISTRIBUTOR	1.000	PC																																																																							
VL1102A1	DETERGENT LINE FILTER + BARBED VNR 6 MM	1.000	PC																																																																							





COMPONENT			SPARE PART																																																											
Code	Description	Image	Code	Description	Kit components																																																									
EL1440A	WATER SELF CLEANING VALVE		KVL1211A	ONE COMPACT AND 0523-EP WASH. SYSTEM KIT	<table border="1"> <thead> <tr> <th>Code</th> <th>Description</th> <th>Qty</th> <th>UOM</th> </tr> </thead> <tbody> <tr> <td>VL1127A1</td> <td>6mm BARBED T-SHAPED FITTING</td> <td>1.000</td> <td>PC</td> </tr> <tr> <td>VL1128A1</td> <td>D6 BARBED CHECK VALVE</td> <td>2.000</td> <td>PC</td> </tr> <tr> <td>VL1165A0</td> <td>BAM-BB6 STRAIGHT FITTING</td> <td>1.000</td> <td>PC</td> </tr> <tr> <td>VL1166A0</td> <td>BB6-AR6 L FITTING</td> <td>1.000</td> <td>PC</td> </tr> <tr> <td>VL1174C0</td> <td>D1.2 MM CALIBRATED NOZZLE</td> <td>1.000</td> <td>PC</td> </tr> <tr> <td>VL1191A0</td> <td>ONE WASHING DISTRIBUTOR OUTLETS KIT</td> <td>1.000</td> <td>PC</td> </tr> <tr> <td>VM2172A0</td> <td>LOCKING CLIP FOR PUMP WITH CIRCUIT</td> <td>2.000</td> <td>PC</td> </tr> </tbody> </table>	Code	Description	Qty	UOM	VL1127A1	6mm BARBED T-SHAPED FITTING	1.000	PC	VL1128A1	D6 BARBED CHECK VALVE	2.000	PC	VL1165A0	BAM-BB6 STRAIGHT FITTING	1.000	PC	VL1166A0	BB6-AR6 L FITTING	1.000	PC	VL1174C0	D1.2 MM CALIBRATED NOZZLE	1.000	PC	VL1191A0	ONE WASHING DISTRIBUTOR OUTLETS KIT	1.000	PC	VM2172A0	LOCKING CLIP FOR PUMP WITH CIRCUIT	2.000	PC																									
			Code	Description	Qty	UOM																																																								
VL1127A1	6mm BARBED T-SHAPED FITTING	1.000	PC																																																											
VL1128A1	D6 BARBED CHECK VALVE	2.000	PC																																																											
VL1165A0	BAM-BB6 STRAIGHT FITTING	1.000	PC																																																											
VL1166A0	BB6-AR6 L FITTING	1.000	PC																																																											
VL1174C0	D1.2 MM CALIBRATED NOZZLE	1.000	PC																																																											
VL1191A0	ONE WASHING DISTRIBUTOR OUTLETS KIT	1.000	PC																																																											
VM2172A0	LOCKING CLIP FOR PUMP WITH CIRCUIT	2.000	PC																																																											
KVL1198A	MM EU HOOD CLEANING SYSTEM KIT	<table border="1"> <thead> <tr> <th>Code</th> <th>Description</th> <th>Qty</th> <th>UOM</th> </tr> </thead> <tbody> <tr> <td>0H2213A1</td> <td>HOOD WATER CIRCUIT PLAT</td> <td>1.000</td> <td>PC</td> </tr> <tr> <td>EL1440A0</td> <td>WATER SELF CLEANING VALVE</td> <td>2.000</td> <td>PC</td> </tr> <tr> <td>GN1526A0</td> <td>INT. D.=6.9 TH=1.8 O-RING</td> <td>5.000</td> <td>PC</td> </tr> <tr> <td>RC1018A0</td> <td>ZINC PLATED D12 ELASTIC CLAMP</td> <td>1.000</td> <td>PC</td> </tr> <tr> <td>RC1019A0</td> <td>D=10 ELASTIC CLAMP</td> <td>14.000</td> <td>PC</td> </tr> <tr> <td>RC1131A0</td> <td>200x2.6 BLACK CLAMP</td> <td>1.000</td> <td>PC</td> </tr> <tr> <td>RC1242A0</td> <td>D=10 CLOSED CAP</td> <td>2.000</td> <td>PC</td> </tr> <tr> <td>RC1414A1</td> <td>D11.5-12.5 SINGLE EAR HOSE CLAMP</td> <td>3.000</td> <td>PC</td> </tr> <tr> <td>TB2821A0</td> <td>EPDM 6X10 L=40MM PIPE</td> <td>4.000</td> <td>PC</td> </tr> <tr> <td>TB2994A0</td> <td>HOOD DETERGENT PIPE</td> <td>2.000</td> <td>PC</td> </tr> <tr> <td>TB3252A0</td> <td>TB3252A0</td> <td>2.000</td> <td>PC</td> </tr> <tr> <td>TB3614A0</td> <td>TB3614A0</td> <td>1.000</td> <td>PC</td> </tr> <tr> <td>V11220A1</td> <td>4,2x12 TCB SELF-TAPPING SCREW</td> <td>3.000</td> <td>PC</td> </tr> <tr> <td>V12070A0</td> <td>SHEETTRACS TCB+ 40x8 SELF-THREAD SCREW</td> <td>2.000</td> <td>PC</td> </tr> </tbody> </table>	Code	Description	Qty	UOM	0H2213A1	HOOD WATER CIRCUIT PLAT	1.000	PC	EL1440A0	WATER SELF CLEANING VALVE	2.000	PC	GN1526A0	INT. D.=6.9 TH=1.8 O-RING	5.000	PC	RC1018A0	ZINC PLATED D12 ELASTIC CLAMP	1.000	PC	RC1019A0	D=10 ELASTIC CLAMP	14.000	PC	RC1131A0	200x2.6 BLACK CLAMP	1.000	PC	RC1242A0	D=10 CLOSED CAP	2.000	PC	RC1414A1	D11.5-12.5 SINGLE EAR HOSE CLAMP	3.000	PC	TB2821A0	EPDM 6X10 L=40MM PIPE	4.000	PC	TB2994A0	HOOD DETERGENT PIPE	2.000	PC	TB3252A0	TB3252A0	2.000	PC	TB3614A0	TB3614A0	1.000	PC	V11220A1	4,2x12 TCB SELF-TAPPING SCREW	3.000	PC	V12070A0	SHEETTRACS TCB+ 40x8 SELF-THREAD SCREW	2.000	PC
Code	Description	Qty	UOM																																																											
0H2213A1	HOOD WATER CIRCUIT PLAT	1.000	PC																																																											
EL1440A0	WATER SELF CLEANING VALVE	2.000	PC																																																											
GN1526A0	INT. D.=6.9 TH=1.8 O-RING	5.000	PC																																																											
RC1018A0	ZINC PLATED D12 ELASTIC CLAMP	1.000	PC																																																											
RC1019A0	D=10 ELASTIC CLAMP	14.000	PC																																																											
RC1131A0	200x2.6 BLACK CLAMP	1.000	PC																																																											
RC1242A0	D=10 CLOSED CAP	2.000	PC																																																											
RC1414A1	D11.5-12.5 SINGLE EAR HOSE CLAMP	3.000	PC																																																											
TB2821A0	EPDM 6X10 L=40MM PIPE	4.000	PC																																																											
TB2994A0	HOOD DETERGENT PIPE	2.000	PC																																																											
TB3252A0	TB3252A0	2.000	PC																																																											
TB3614A0	TB3614A0	1.000	PC																																																											
V11220A1	4,2x12 TCB SELF-TAPPING SCREW	3.000	PC																																																											
V12070A0	SHEETTRACS TCB+ 40x8 SELF-THREAD SCREW	2.000	PC																																																											



COMPONENT			SPARE PART																																																																																	
Code	Description	Image	Code	Description	Kit components																																																																															
EL1440A	WATER SELF CLEANING VALVE		KVL1198A	MM EU HOOD CLEANING SYSTEM KIT	<table border="1"> <thead> <tr> <th>Code</th> <th>Description</th> <th>Qty</th> <th>UOM</th> </tr> </thead> <tbody> <tr> <td>VL1019A0</td> <td>VIBRATION DETERGENT PUMP</td> <td>1.000</td> <td>PC</td> </tr> <tr> <td>VL1047A1</td> <td>D6 PIPE HOLDER - D8 J.G. TERMINAL</td> <td>2.000</td> <td>PC</td> </tr> <tr> <td>VL1054B0</td> <td>ONE WASHING SYS INLET DISTRIBUTOR</td> <td>1.000</td> <td>PC</td> </tr> <tr> <td>VL1102A1</td> <td>DETERGENT LINE FILTER + BARBED VNR 6 MM</td> <td>1.000</td> <td>PC</td> </tr> <tr> <td>VL1127A1</td> <td>6mm BARBED T-SHAPED FITTING</td> <td>1.000</td> <td>PC</td> </tr> <tr> <td>VL1128A1</td> <td>D6 BARBED CHECK VALVE</td> <td>1.000</td> <td>PC</td> </tr> <tr> <td>VL1165A0</td> <td>BAM-BB6 STRAIGHT FITTING</td> <td>1.000</td> <td>PC</td> </tr> <tr> <td>VL1166A0</td> <td>BB6-AR6 L FITTING</td> <td>2.000</td> <td>PC</td> </tr> <tr> <td>VL1174C0</td> <td>D1.2 MM CALIBRATED NOZZLE</td> <td>1.000</td> <td>PC</td> </tr> <tr> <td>VL1191A0</td> <td>ONE WASHING DISTRIBUTOR OUTLETS KIT</td> <td>1.000</td> <td>PC</td> </tr> <tr> <td>VL1214A0</td> <td>BAYONET - 6mm BARBED NRV VALVE</td> <td>1.000</td> <td>PC</td> </tr> <tr> <td>VM1605A0</td> <td>CLIP TWIST LOCK DIAM. 10,2-12,7 MM</td> <td>2.000</td> <td>PC</td> </tr> <tr> <td>VM2172A0</td> <td>LOCKING CLIP FOR PUMP WITH CIRCUIT</td> <td>3.000</td> <td>PC</td> </tr> </tbody> </table>	Code	Description	Qty	UOM	VL1019A0	VIBRATION DETERGENT PUMP	1.000	PC	VL1047A1	D6 PIPE HOLDER - D8 J.G. TERMINAL	2.000	PC	VL1054B0	ONE WASHING SYS INLET DISTRIBUTOR	1.000	PC	VL1102A1	DETERGENT LINE FILTER + BARBED VNR 6 MM	1.000	PC	VL1127A1	6mm BARBED T-SHAPED FITTING	1.000	PC	VL1128A1	D6 BARBED CHECK VALVE	1.000	PC	VL1165A0	BAM-BB6 STRAIGHT FITTING	1.000	PC	VL1166A0	BB6-AR6 L FITTING	2.000	PC	VL1174C0	D1.2 MM CALIBRATED NOZZLE	1.000	PC	VL1191A0	ONE WASHING DISTRIBUTOR OUTLETS KIT	1.000	PC	VL1214A0	BAYONET - 6mm BARBED NRV VALVE	1.000	PC	VM1605A0	CLIP TWIST LOCK DIAM. 10,2-12,7 MM	2.000	PC	VM2172A0	LOCKING CLIP FOR PUMP WITH CIRCUIT	3.000	PC	KVL1187A	3 ROTOR ARMS PLUS EU CLEANING SYSTEM KIT	<table border="1"> <thead> <tr> <th>Code</th> <th>Description</th> <th>Qty</th> <th>UOM</th> </tr> </thead> <tbody> <tr> <td>0H2354A1</td> <td>XEVC-XEVL PLUS WASHING CIRCUIT PLAT</td> <td>1.000</td> <td>PC</td> </tr> <tr> <td>EL1440A0</td> <td>WATER SELF CLEANING VALVE</td> <td>4.000</td> <td>PC</td> </tr> <tr> <td>GN1526A0</td> <td>INT. D.=6.9 TH=1.8 O-RIN</td> <td>9.000</td> <td>PC</td> </tr> <tr> <td>RC1018A0</td> <td>ZINC PLATED D12 ELASTIC CLAMP</td> <td>11.000</td> <td>PC</td> </tr> </tbody> </table>	Code	Description	Qty	UOM	0H2354A1	XEVC-XEVL PLUS WASHING CIRCUIT PLAT	1.000	PC	EL1440A0	WATER SELF CLEANING VALVE	4.000	PC	GN1526A0	INT. D.=6.9 TH=1.8 O-RIN	9.000	PC	RC1018A0	ZINC PLATED D12 ELASTIC CLAMP	11.000	PC
			Code	Description	Qty	UOM																																																																														
VL1019A0	VIBRATION DETERGENT PUMP	1.000	PC																																																																																	
VL1047A1	D6 PIPE HOLDER - D8 J.G. TERMINAL	2.000	PC																																																																																	
VL1054B0	ONE WASHING SYS INLET DISTRIBUTOR	1.000	PC																																																																																	
VL1102A1	DETERGENT LINE FILTER + BARBED VNR 6 MM	1.000	PC																																																																																	
VL1127A1	6mm BARBED T-SHAPED FITTING	1.000	PC																																																																																	
VL1128A1	D6 BARBED CHECK VALVE	1.000	PC																																																																																	
VL1165A0	BAM-BB6 STRAIGHT FITTING	1.000	PC																																																																																	
VL1166A0	BB6-AR6 L FITTING	2.000	PC																																																																																	
VL1174C0	D1.2 MM CALIBRATED NOZZLE	1.000	PC																																																																																	
VL1191A0	ONE WASHING DISTRIBUTOR OUTLETS KIT	1.000	PC																																																																																	
VL1214A0	BAYONET - 6mm BARBED NRV VALVE	1.000	PC																																																																																	
VM1605A0	CLIP TWIST LOCK DIAM. 10,2-12,7 MM	2.000	PC																																																																																	
VM2172A0	LOCKING CLIP FOR PUMP WITH CIRCUIT	3.000	PC																																																																																	
Code	Description	Qty	UOM																																																																																	
0H2354A1	XEVC-XEVL PLUS WASHING CIRCUIT PLAT	1.000	PC																																																																																	
EL1440A0	WATER SELF CLEANING VALVE	4.000	PC																																																																																	
GN1526A0	INT. D.=6.9 TH=1.8 O-RIN	9.000	PC																																																																																	
RC1018A0	ZINC PLATED D12 ELASTIC CLAMP	11.000	PC																																																																																	

COMPONENT			SPARE PART																																																																																														
Code	Description	Image	Code	Description	Kit components																																																																																												
EL1440A	WATER SELF CLEANING VALVE		KVL1187A	3 ROTOR ARMS PLUS EU CLEANING SYSTEM KIT	<table border="1"> <thead> <tr> <th>Code</th> <th>Description</th> <th>Qty</th> <th>UOM</th> </tr> </thead> <tbody> <tr> <td>RC1019A0</td> <td>D=10 ELASTIC CLAMP</td> <td>14.000</td> <td>PC</td> </tr> <tr> <td>RC1130A0</td> <td>130x2,6 CLAM</td> <td>1.000</td> <td>PC</td> </tr> <tr> <td>RC1131A0</td> <td>200x2,6 BLACK CLAMP</td> <td>3.000</td> <td>PC</td> </tr> <tr> <td>RC1242A0</td> <td>D=10 CLOSED CAP</td> <td>2.000</td> <td>PC</td> </tr> <tr> <td>RC1356A0</td> <td>"STRAIGHT THREADED FEMALE END 8x1/4" BS</td> <td>1.000</td> <td>PC</td> </tr> <tr> <td>RC1414A1</td> <td>D11,5-12,5 SINGLE EAR HOSE CLAMP</td> <td>1.000</td> <td>PC</td> </tr> <tr> <td>TB2652A0</td> <td></td> <td>1.000</td> <td>PC</td> </tr> <tr> <td>TB2677A0</td> <td></td> <td>1.000</td> <td>PC</td> </tr> <tr> <td>TB2821A0</td> <td>EPDM 6X10 L=40MM PIPE</td> <td>4.000</td> <td>PC</td> </tr> <tr> <td>TB3004A0</td> <td>TB2820A L=550mm EPDM BLACK PIPE</td> <td>2.000</td> <td>PC</td> </tr> <tr> <td>TB3024C0</td> <td></td> <td>3.000</td> <td>PC</td> </tr> <tr> <td>TB3226A0</td> <td></td> <td>1.000</td> <td>PC</td> </tr> <tr> <td>TB3440A0</td> <td>TB3132A L=1050mm EPDM WHITE-BLUE PIPE</td> <td>1.000</td> <td>PC</td> </tr> <tr> <td>TB3614A0</td> <td>TB3614A0</td> <td>1.000</td> <td>PC</td> </tr> <tr> <td>VI1220A1</td> <td>4,2x12 TCB SELF-TAPPIN G SCREW</td> <td>1.000</td> <td>PC</td> </tr> <tr> <td>VL1019A0</td> <td>VIBRATION DETERGENT PUMP</td> <td>1.000</td> <td>PC</td> </tr> <tr> <td>VL1047A1</td> <td>D6 PIPE HOLDER - D8 J.G. TERMINAL</td> <td>1.000</td> <td>PC</td> </tr> <tr> <td>VL1065A1</td> <td>1/4 MALE N.O. PRESSURE SWITCH</td> <td>1.000</td> <td>PC</td> </tr> <tr> <td>VL1102A1</td> <td>DETERGENT LINE FILTER + BARBED VNR 6 MM</td> <td>1.000</td> <td>PC</td> </tr> <tr> <td>VL1127A1</td> <td>6mm BARBED T-SHAPED FITTING</td> <td>2.000</td> <td>PC</td> </tr> <tr> <td>VL1128A1</td> <td>D6 BARBED CHECK VALVE</td> <td>2.000</td> <td>PC</td> </tr> <tr> <td>VL1166A0</td> <td>BB6-AR6 L FITTING</td> <td>4.000</td> <td>PC</td> </tr> </tbody> </table>	Code	Description	Qty	UOM	RC1019A0	D=10 ELASTIC CLAMP	14.000	PC	RC1130A0	130x2,6 CLAM	1.000	PC	RC1131A0	200x2,6 BLACK CLAMP	3.000	PC	RC1242A0	D=10 CLOSED CAP	2.000	PC	RC1356A0	"STRAIGHT THREADED FEMALE END 8x1/4" BS	1.000	PC	RC1414A1	D11,5-12,5 SINGLE EAR HOSE CLAMP	1.000	PC	TB2652A0		1.000	PC	TB2677A0		1.000	PC	TB2821A0	EPDM 6X10 L=40MM PIPE	4.000	PC	TB3004A0	TB2820A L=550mm EPDM BLACK PIPE	2.000	PC	TB3024C0		3.000	PC	TB3226A0		1.000	PC	TB3440A0	TB3132A L=1050mm EPDM WHITE-BLUE PIPE	1.000	PC	TB3614A0	TB3614A0	1.000	PC	VI1220A1	4,2x12 TCB SELF-TAPPIN G SCREW	1.000	PC	VL1019A0	VIBRATION DETERGENT PUMP	1.000	PC	VL1047A1	D6 PIPE HOLDER - D8 J.G. TERMINAL	1.000	PC	VL1065A1	1/4 MALE N.O. PRESSURE SWITCH	1.000	PC	VL1102A1	DETERGENT LINE FILTER + BARBED VNR 6 MM	1.000	PC	VL1127A1	6mm BARBED T-SHAPED FITTING	2.000	PC	VL1128A1	D6 BARBED CHECK VALVE	2.000	PC	VL1166A0	BB6-AR6 L FITTING	4.000	PC
Code	Description	Qty	UOM																																																																																														
RC1019A0	D=10 ELASTIC CLAMP	14.000	PC																																																																																														
RC1130A0	130x2,6 CLAM	1.000	PC																																																																																														
RC1131A0	200x2,6 BLACK CLAMP	3.000	PC																																																																																														
RC1242A0	D=10 CLOSED CAP	2.000	PC																																																																																														
RC1356A0	"STRAIGHT THREADED FEMALE END 8x1/4" BS	1.000	PC																																																																																														
RC1414A1	D11,5-12,5 SINGLE EAR HOSE CLAMP	1.000	PC																																																																																														
TB2652A0		1.000	PC																																																																																														
TB2677A0		1.000	PC																																																																																														
TB2821A0	EPDM 6X10 L=40MM PIPE	4.000	PC																																																																																														
TB3004A0	TB2820A L=550mm EPDM BLACK PIPE	2.000	PC																																																																																														
TB3024C0		3.000	PC																																																																																														
TB3226A0		1.000	PC																																																																																														
TB3440A0	TB3132A L=1050mm EPDM WHITE-BLUE PIPE	1.000	PC																																																																																														
TB3614A0	TB3614A0	1.000	PC																																																																																														
VI1220A1	4,2x12 TCB SELF-TAPPIN G SCREW	1.000	PC																																																																																														
VL1019A0	VIBRATION DETERGENT PUMP	1.000	PC																																																																																														
VL1047A1	D6 PIPE HOLDER - D8 J.G. TERMINAL	1.000	PC																																																																																														
VL1065A1	1/4 MALE N.O. PRESSURE SWITCH	1.000	PC																																																																																														
VL1102A1	DETERGENT LINE FILTER + BARBED VNR 6 MM	1.000	PC																																																																																														
VL1127A1	6mm BARBED T-SHAPED FITTING	2.000	PC																																																																																														
VL1128A1	D6 BARBED CHECK VALVE	2.000	PC																																																																																														
VL1166A0	BB6-AR6 L FITTING	4.000	PC																																																																																														

COMPONENT			SPARE PART																																															
Code	Description	Image	Code	Description	Kit components																																													
EL1440A	WATER SELF CLEANING VALVE		KVL1187A	3 ROTOR ARMS PLUS EU CLEANING SYSTEM KIT	<table border="1"> <thead> <tr> <th>Code</th> <th>Description</th> <th>Qty</th> <th>UOM</th> </tr> </thead> <tbody> <tr> <td>VL1167A2</td> <td>GN21 3 ROTOR ARMS B-B FLOW RESTRICTOR</td> <td>1.000</td> <td>PC</td> </tr> <tr> <td>VL1174C0</td> <td>D1.2 MM CALIBRATED NOZZLE</td> <td>1.000</td> <td>PC</td> </tr> <tr> <td>VL1186A0</td> <td>3 WAYS PLUS WASHING DISTRIBUTOR</td> <td>1.000</td> <td>PC</td> </tr> <tr> <td>VL1190A0</td> <td>PLUS WASHING SYSTEM INLET DISTRIBUTOR</td> <td>1.000</td> <td>PC</td> </tr> <tr> <td>VL1214A0</td> <td>BAYONET - 6mm BARBED NRV VALVE</td> <td>1.000</td> <td>PC</td> </tr> <tr> <td>VM1605A0</td> <td>CLIP TWIST LOCK DIAM. 10,2-12,7 MM</td> <td>3.000</td> <td>PC</td> </tr> <tr> <td>VM2172A0</td> <td>LOCKING CLIP FOR PUMP WITH CIRCUIT</td> <td>5.000</td> <td>PC</td> </tr> </tbody> </table>	Code	Description	Qty	UOM	VL1167A2	GN21 3 ROTOR ARMS B-B FLOW RESTRICTOR	1.000	PC	VL1174C0	D1.2 MM CALIBRATED NOZZLE	1.000	PC	VL1186A0	3 WAYS PLUS WASHING DISTRIBUTOR	1.000	PC	VL1190A0	PLUS WASHING SYSTEM INLET DISTRIBUTOR	1.000	PC	VL1214A0	BAYONET - 6mm BARBED NRV VALVE	1.000	PC	VM1605A0	CLIP TWIST LOCK DIAM. 10,2-12,7 MM	3.000	PC	VM2172A0	LOCKING CLIP FOR PUMP WITH CIRCUIT	5.000	PC													
			Code	Description	Qty	UOM																																												
VL1167A2	GN21 3 ROTOR ARMS B-B FLOW RESTRICTOR	1.000	PC																																															
VL1174C0	D1.2 MM CALIBRATED NOZZLE	1.000	PC																																															
VL1186A0	3 WAYS PLUS WASHING DISTRIBUTOR	1.000	PC																																															
VL1190A0	PLUS WASHING SYSTEM INLET DISTRIBUTOR	1.000	PC																																															
VL1214A0	BAYONET - 6mm BARBED NRV VALVE	1.000	PC																																															
VM1605A0	CLIP TWIST LOCK DIAM. 10,2-12,7 MM	3.000	PC																																															
VM2172A0	LOCKING CLIP FOR PUMP WITH CIRCUIT	5.000	PC																																															
KVL1184A	2 ROTOR ARMS PLUS EU CLEANING SYSTEM KIT	<table border="1"> <thead> <tr> <th>Code</th> <th>Description</th> <th>Qty</th> <th>UOM</th> </tr> </thead> <tbody> <tr> <td>0H2354A1</td> <td>XEVC-XEVL PLUS WASHING CIRCUIT PLAT</td> <td>1.000</td> <td>PC</td> </tr> <tr> <td>EL1440A0</td> <td>WATER SELF CLEANING VALVE</td> <td>4.000</td> <td>PC</td> </tr> <tr> <td>GN1526A0</td> <td>INT. D.=6.9 TH=1.8 O-RIN</td> <td>9.000</td> <td>PC</td> </tr> <tr> <td>RC1018A0</td> <td>ZINC PLATED D12 ELASTIC CLAMP</td> <td>2.000</td> <td>PC</td> </tr> <tr> <td>RC1019A0</td> <td>D=10 ELASTIC CLAMP</td> <td>13.000</td> <td>PC</td> </tr> <tr> <td>RC1130A0</td> <td>130x2,6 CLAM</td> <td>1.000</td> <td>PC</td> </tr> <tr> <td>RC1131A0</td> <td>200x2,6 BLACK CLAMP</td> <td>3.000</td> <td>PC</td> </tr> <tr> <td>RC1242A0</td> <td>D=10 CLOSED CAP</td> <td>2.000</td> <td>PC</td> </tr> <tr> <td>RC1356A0</td> <td>"STRAIGHT THREADED FEMALE END 8x1/4" BS</td> <td>1.000</td> <td>PC</td> </tr> <tr> <td>RC1414A1</td> <td>D11.5-12.5 SINGLE EAR HOSE CLAMP</td> <td>1.000</td> <td>PC</td> </tr> <tr> <td>TB2821A0</td> <td>EPDM 6X10 L=40MM PIPE</td> <td>4.000</td> <td>PC</td> </tr> </tbody> </table>	Code	Description	Qty	UOM	0H2354A1	XEVC-XEVL PLUS WASHING CIRCUIT PLAT	1.000	PC	EL1440A0	WATER SELF CLEANING VALVE	4.000	PC	GN1526A0	INT. D.=6.9 TH=1.8 O-RIN	9.000	PC	RC1018A0	ZINC PLATED D12 ELASTIC CLAMP	2.000	PC	RC1019A0	D=10 ELASTIC CLAMP	13.000	PC	RC1130A0	130x2,6 CLAM	1.000	PC	RC1131A0	200x2,6 BLACK CLAMP	3.000	PC	RC1242A0	D=10 CLOSED CAP	2.000	PC	RC1356A0	"STRAIGHT THREADED FEMALE END 8x1/4" BS	1.000	PC	RC1414A1	D11.5-12.5 SINGLE EAR HOSE CLAMP	1.000	PC	TB2821A0	EPDM 6X10 L=40MM PIPE	4.000	PC
Code	Description	Qty	UOM																																															
0H2354A1	XEVC-XEVL PLUS WASHING CIRCUIT PLAT	1.000	PC																																															
EL1440A0	WATER SELF CLEANING VALVE	4.000	PC																																															
GN1526A0	INT. D.=6.9 TH=1.8 O-RIN	9.000	PC																																															
RC1018A0	ZINC PLATED D12 ELASTIC CLAMP	2.000	PC																																															
RC1019A0	D=10 ELASTIC CLAMP	13.000	PC																																															
RC1130A0	130x2,6 CLAM	1.000	PC																																															
RC1131A0	200x2,6 BLACK CLAMP	3.000	PC																																															
RC1242A0	D=10 CLOSED CAP	2.000	PC																																															
RC1356A0	"STRAIGHT THREADED FEMALE END 8x1/4" BS	1.000	PC																																															
RC1414A1	D11.5-12.5 SINGLE EAR HOSE CLAMP	1.000	PC																																															
TB2821A0	EPDM 6X10 L=40MM PIPE	4.000	PC																																															

COMPONENT			SPARE PART																																																																														
Code	Description	Image	Code	Description	Kit components																																																																												
EL1440A	WATER SELF CLEANING VALVE		KVL1184A	2 ROTOR ARMS PLUS EU CLEANING SYSTEM KIT	<table border="1"> <thead> <tr> <th>Code</th> <th>Description</th> <th>Qty</th> <th>UOM</th> </tr> </thead> <tbody> <tr> <td>TB2994A0</td> <td>HOOD DETERGENT PIPE</td> <td>1.000</td> <td>PC</td> </tr> <tr> <td>TB3004A0</td> <td>TB2820A L=550mm EPDM BLACK PIPE</td> <td>2.000</td> <td>PC</td> </tr> <tr> <td>TB3005B0</td> <td>TB3132A L=550mm EPDM WHITE-BLUE PIPE</td> <td>1.000</td> <td>PC</td> </tr> <tr> <td>TB3440A0</td> <td>TB3132A L=1050mm EPDM WHITE-BLUE PIPE</td> <td>1.000</td> <td>PC</td> </tr> <tr> <td>TB3614A0</td> <td>TB3614A0</td> <td>1.000</td> <td>PC</td> </tr> <tr> <td>VI1220A1</td> <td>4,2x12 TCB SELF-TAPPIN G SCREW</td> <td>1.000</td> <td>PC</td> </tr> <tr> <td>VL1019A0</td> <td>VIBRATION DETERGENT PUMP</td> <td>1.000</td> <td>PC</td> </tr> <tr> <td>VL1047A1</td> <td>D6 PIPE HOLDER - D8 J.G. TERMINAL</td> <td>1.000</td> <td>PC</td> </tr> <tr> <td>VL1065A1</td> <td>1/4 MALE N.O. PRESSURE SWITCH</td> <td>1.000</td> <td>PC</td> </tr> <tr> <td>VL1102A1</td> <td>DETERGENT LINE FILTER + BARBED VNR 6 MM</td> <td>1.000</td> <td>PC</td> </tr> <tr> <td>VL1128A1</td> <td>D6 BARBED CHECK VALVE</td> <td>1.000</td> <td>PC</td> </tr> <tr> <td>VL1166A0</td> <td>BB6-AR6 L FITTING</td> <td>4.000</td> <td>PC</td> </tr> <tr> <td>VL1174C0</td> <td>D1.2 MM CALIBRATED NOZZLE</td> <td>1.000</td> <td>PC</td> </tr> <tr> <td>VL1186A0</td> <td>3 WAYS PLUS WASHING DISTRIBUTOR</td> <td>1.000</td> <td>PC</td> </tr> <tr> <td>VL1190A0</td> <td>PLUS WASHING SYSTEM INLET DISTRIBUTOR</td> <td>1.000</td> <td>PC</td> </tr> <tr> <td>VL1214A0</td> <td>BAYONET - 6mm BARBED NRV VALVE</td> <td>1.000</td> <td>PC</td> </tr> <tr> <td>VM1605A0</td> <td>CLIP TWIST LOCK DIAM. 10,2-12,7 MM</td> <td>3.000</td> <td>PC</td> </tr> <tr> <td>VM2172A0</td> <td>LOCKING CLIP FOR PUMP WITH CIRCUIT</td> <td>5.000</td> <td>PC</td> </tr> </tbody> </table>	Code	Description	Qty	UOM	TB2994A0	HOOD DETERGENT PIPE	1.000	PC	TB3004A0	TB2820A L=550mm EPDM BLACK PIPE	2.000	PC	TB3005B0	TB3132A L=550mm EPDM WHITE-BLUE PIPE	1.000	PC	TB3440A0	TB3132A L=1050mm EPDM WHITE-BLUE PIPE	1.000	PC	TB3614A0	TB3614A0	1.000	PC	VI1220A1	4,2x12 TCB SELF-TAPPIN G SCREW	1.000	PC	VL1019A0	VIBRATION DETERGENT PUMP	1.000	PC	VL1047A1	D6 PIPE HOLDER - D8 J.G. TERMINAL	1.000	PC	VL1065A1	1/4 MALE N.O. PRESSURE SWITCH	1.000	PC	VL1102A1	DETERGENT LINE FILTER + BARBED VNR 6 MM	1.000	PC	VL1128A1	D6 BARBED CHECK VALVE	1.000	PC	VL1166A0	BB6-AR6 L FITTING	4.000	PC	VL1174C0	D1.2 MM CALIBRATED NOZZLE	1.000	PC	VL1186A0	3 WAYS PLUS WASHING DISTRIBUTOR	1.000	PC	VL1190A0	PLUS WASHING SYSTEM INLET DISTRIBUTOR	1.000	PC	VL1214A0	BAYONET - 6mm BARBED NRV VALVE	1.000	PC	VM1605A0	CLIP TWIST LOCK DIAM. 10,2-12,7 MM	3.000	PC	VM2172A0	LOCKING CLIP FOR PUMP WITH CIRCUIT	5.000	PC
Code	Description	Qty	UOM																																																																														
TB2994A0	HOOD DETERGENT PIPE	1.000	PC																																																																														
TB3004A0	TB2820A L=550mm EPDM BLACK PIPE	2.000	PC																																																																														
TB3005B0	TB3132A L=550mm EPDM WHITE-BLUE PIPE	1.000	PC																																																																														
TB3440A0	TB3132A L=1050mm EPDM WHITE-BLUE PIPE	1.000	PC																																																																														
TB3614A0	TB3614A0	1.000	PC																																																																														
VI1220A1	4,2x12 TCB SELF-TAPPIN G SCREW	1.000	PC																																																																														
VL1019A0	VIBRATION DETERGENT PUMP	1.000	PC																																																																														
VL1047A1	D6 PIPE HOLDER - D8 J.G. TERMINAL	1.000	PC																																																																														
VL1065A1	1/4 MALE N.O. PRESSURE SWITCH	1.000	PC																																																																														
VL1102A1	DETERGENT LINE FILTER + BARBED VNR 6 MM	1.000	PC																																																																														
VL1128A1	D6 BARBED CHECK VALVE	1.000	PC																																																																														
VL1166A0	BB6-AR6 L FITTING	4.000	PC																																																																														
VL1174C0	D1.2 MM CALIBRATED NOZZLE	1.000	PC																																																																														
VL1186A0	3 WAYS PLUS WASHING DISTRIBUTOR	1.000	PC																																																																														
VL1190A0	PLUS WASHING SYSTEM INLET DISTRIBUTOR	1.000	PC																																																																														
VL1214A0	BAYONET - 6mm BARBED NRV VALVE	1.000	PC																																																																														
VM1605A0	CLIP TWIST LOCK DIAM. 10,2-12,7 MM	3.000	PC																																																																														
VM2172A0	LOCKING CLIP FOR PUMP WITH CIRCUIT	5.000	PC																																																																														



COMPONENT			SPARE PART																																																																																		
Code	Description	Image	Code	Description	Kit components																																																																																
EL1440A	WATER SELF CLEANING VALVE		KVL1183A	1 ROTOR ARM PLUS CLEANING SYSTEM KIT	<table border="1"> <thead> <tr> <th>Code</th> <th>Description</th> <th>Qty</th> <th>UOM</th> </tr> </thead> <tbody> <tr> <td>0H2354A1</td> <td>XEVC-XEVL PLUS WASHING CIRCUIT PLAT</td> <td>1.000</td> <td>PC</td> </tr> <tr> <td>EL1440A0</td> <td>WATER SELF CLEANING VALVE</td> <td>3.000</td> <td>PC</td> </tr> <tr> <td>GN1526A0</td> <td>INT. D.=6.9 TH=1.8 O-RIN</td> <td>7.000</td> <td>PC</td> </tr> <tr> <td>RC1018A0</td> <td>ZINC PLATED D12 ELASTIC CLAMP</td> <td>1.000</td> <td>PC</td> </tr> <tr> <td>RC1019A0</td> <td>D=10 ELASTIC CLAMP</td> <td>12.000</td> <td>PC</td> </tr> <tr> <td>RC1130A0</td> <td>130x2,6 CLAM</td> <td>1.000</td> <td>PC</td> </tr> <tr> <td>RC1131A0</td> <td>200x2,6 BLACK CLAMP</td> <td>2.000</td> <td>PC</td> </tr> <tr> <td>RC1242A0</td> <td>D=10 CLOSED CAP</td> <td>2.000</td> <td>PC</td> </tr> <tr> <td>RC1356A0</td> <td>"STRAIGHT THREADED FEMALE END 8x1/4" BS</td> <td>1.000</td> <td>PC</td> </tr> <tr> <td>RC1414A1</td> <td>D11.5-12.5 SINGLE EAR HOSE CLAMP</td> <td>1.000</td> <td>PC</td> </tr> <tr> <td>TB2821A0</td> <td>EPDM 6X10 L=40MM PIPE</td> <td>4.000</td> <td>PC</td> </tr> <tr> <td>TB3004A0</td> <td>TB2820A L=550mm EPDM BLACK PIPE</td> <td>1.000</td> <td>PC</td> </tr> <tr> <td>TB3005B0</td> <td>TB3132A L=550mm EPDM WHITE-BLUE PIPE</td> <td>1.000</td> <td>PC</td> </tr> <tr> <td>TB3225B0</td> <td>TB2820A-TAN K-WASHYNG SYS CONNECTION</td> <td>1.000</td> <td>PC</td> </tr> <tr> <td>TB3252A0</td> <td>TB3252A0</td> <td>1.000</td> <td>PC</td> </tr> <tr> <td>TB3614A0</td> <td>TB3614A0</td> <td>1.000</td> <td>PC</td> </tr> <tr> <td>VH1220A1</td> <td>4,2x12 TCB SELF-TAPPIN G SCREW</td> <td>1.000</td> <td>PC</td> </tr> <tr> <td>VL1019A0</td> <td>VIBRATION DETERGENT PUMP</td> <td>1.000</td> <td>PC</td> </tr> <tr> <td>VL1047A1</td> <td>D6 PIPE HOLDER - D8 J.G. TERMINAL</td> <td>1.000</td> <td>PC</td> </tr> </tbody> </table>	Code	Description	Qty	UOM	0H2354A1	XEVC-XEVL PLUS WASHING CIRCUIT PLAT	1.000	PC	EL1440A0	WATER SELF CLEANING VALVE	3.000	PC	GN1526A0	INT. D.=6.9 TH=1.8 O-RIN	7.000	PC	RC1018A0	ZINC PLATED D12 ELASTIC CLAMP	1.000	PC	RC1019A0	D=10 ELASTIC CLAMP	12.000	PC	RC1130A0	130x2,6 CLAM	1.000	PC	RC1131A0	200x2,6 BLACK CLAMP	2.000	PC	RC1242A0	D=10 CLOSED CAP	2.000	PC	RC1356A0	"STRAIGHT THREADED FEMALE END 8x1/4" BS	1.000	PC	RC1414A1	D11.5-12.5 SINGLE EAR HOSE CLAMP	1.000	PC	TB2821A0	EPDM 6X10 L=40MM PIPE	4.000	PC	TB3004A0	TB2820A L=550mm EPDM BLACK PIPE	1.000	PC	TB3005B0	TB3132A L=550mm EPDM WHITE-BLUE PIPE	1.000	PC	TB3225B0	TB2820A-TAN K-WASHYNG SYS CONNECTION	1.000	PC	TB3252A0	TB3252A0	1.000	PC	TB3614A0	TB3614A0	1.000	PC	VH1220A1	4,2x12 TCB SELF-TAPPIN G SCREW	1.000	PC	VL1019A0	VIBRATION DETERGENT PUMP	1.000	PC	VL1047A1	D6 PIPE HOLDER - D8 J.G. TERMINAL	1.000	PC
Code	Description	Qty	UOM																																																																																		
0H2354A1	XEVC-XEVL PLUS WASHING CIRCUIT PLAT	1.000	PC																																																																																		
EL1440A0	WATER SELF CLEANING VALVE	3.000	PC																																																																																		
GN1526A0	INT. D.=6.9 TH=1.8 O-RIN	7.000	PC																																																																																		
RC1018A0	ZINC PLATED D12 ELASTIC CLAMP	1.000	PC																																																																																		
RC1019A0	D=10 ELASTIC CLAMP	12.000	PC																																																																																		
RC1130A0	130x2,6 CLAM	1.000	PC																																																																																		
RC1131A0	200x2,6 BLACK CLAMP	2.000	PC																																																																																		
RC1242A0	D=10 CLOSED CAP	2.000	PC																																																																																		
RC1356A0	"STRAIGHT THREADED FEMALE END 8x1/4" BS	1.000	PC																																																																																		
RC1414A1	D11.5-12.5 SINGLE EAR HOSE CLAMP	1.000	PC																																																																																		
TB2821A0	EPDM 6X10 L=40MM PIPE	4.000	PC																																																																																		
TB3004A0	TB2820A L=550mm EPDM BLACK PIPE	1.000	PC																																																																																		
TB3005B0	TB3132A L=550mm EPDM WHITE-BLUE PIPE	1.000	PC																																																																																		
TB3225B0	TB2820A-TAN K-WASHYNG SYS CONNECTION	1.000	PC																																																																																		
TB3252A0	TB3252A0	1.000	PC																																																																																		
TB3614A0	TB3614A0	1.000	PC																																																																																		
VH1220A1	4,2x12 TCB SELF-TAPPIN G SCREW	1.000	PC																																																																																		
VL1019A0	VIBRATION DETERGENT PUMP	1.000	PC																																																																																		
VL1047A1	D6 PIPE HOLDER - D8 J.G. TERMINAL	1.000	PC																																																																																		







COMPONENT			SPARE PART																																														
Code	Description	Image	Code	Description	Kit components																																												
EL1440A	WATER SELF CLEANING VALVE		KVL1183A	1 ROTOR ARM PLUS CLEANING SYSTEM KIT	<table border="1"> <thead> <tr> <th>Code</th> <th>Description</th> <th>Qty</th> <th>UOM</th> </tr> </thead> <tbody> <tr> <td>VL1102A1</td> <td>DETERGENT LINE FILTER + BARBED VNR 6 MM</td> <td>1.000</td> <td>PC</td> </tr> <tr> <td>VL1128A1</td> <td>D6 BARBED CHECK VALVE</td> <td>1.000</td> <td>PC</td> </tr> <tr> <td>VL1166A0</td> <td>BB6-AR6 L FITTING</td> <td>3.000</td> <td>PC</td> </tr> <tr> <td>VL1174C0</td> <td>D1.2 MM CALIBRATED NOZZLE</td> <td>1.000</td> <td>PC</td> </tr> <tr> <td>VL1185A0</td> <td>2 WAYS PLUS WASHING DISTRIBUTOR</td> <td>1.000</td> <td>PC</td> </tr> <tr> <td>VL1190A0</td> <td>PLUS WASHING SYSTEM INLET DISTRIBUTOR</td> <td>1.000</td> <td>PC</td> </tr> <tr> <td>VL1214A0</td> <td>BAYONET - 6mm BARBED NRV VALVE</td> <td>1.000</td> <td>PC</td> </tr> <tr> <td>VL1398A0</td> <td>1/4 M N.O. CIL PRESSURE SWITCH</td> <td>1.000</td> <td>PC</td> </tr> <tr> <td>VM1605A0</td> <td>CLIP TWIST LOCK DIAM. 10,2-12,7 MM</td> <td>3.000</td> <td>PC</td> </tr> <tr> <td>VM2172A0</td> <td>LOCKING CLIP FOR PUMP WITH CIRCUIT</td> <td>4.000</td> <td>PC</td> </tr> </tbody> </table>	Code	Description	Qty	UOM	VL1102A1	DETERGENT LINE FILTER + BARBED VNR 6 MM	1.000	PC	VL1128A1	D6 BARBED CHECK VALVE	1.000	PC	VL1166A0	BB6-AR6 L FITTING	3.000	PC	VL1174C0	D1.2 MM CALIBRATED NOZZLE	1.000	PC	VL1185A0	2 WAYS PLUS WASHING DISTRIBUTOR	1.000	PC	VL1190A0	PLUS WASHING SYSTEM INLET DISTRIBUTOR	1.000	PC	VL1214A0	BAYONET - 6mm BARBED NRV VALVE	1.000	PC	VL1398A0	1/4 M N.O. CIL PRESSURE SWITCH	1.000	PC	VM1605A0	CLIP TWIST LOCK DIAM. 10,2-12,7 MM	3.000	PC	VM2172A0	LOCKING CLIP FOR PUMP WITH CIRCUIT	4.000	PC
			Code	Description	Qty	UOM																																											
VL1102A1	DETERGENT LINE FILTER + BARBED VNR 6 MM	1.000	PC																																														
VL1128A1	D6 BARBED CHECK VALVE	1.000	PC																																														
VL1166A0	BB6-AR6 L FITTING	3.000	PC																																														
VL1174C0	D1.2 MM CALIBRATED NOZZLE	1.000	PC																																														
VL1185A0	2 WAYS PLUS WASHING DISTRIBUTOR	1.000	PC																																														
VL1190A0	PLUS WASHING SYSTEM INLET DISTRIBUTOR	1.000	PC																																														
VL1214A0	BAYONET - 6mm BARBED NRV VALVE	1.000	PC																																														
VL1398A0	1/4 M N.O. CIL PRESSURE SWITCH	1.000	PC																																														
VM1605A0	CLIP TWIST LOCK DIAM. 10,2-12,7 MM	3.000	PC																																														
VM2172A0	LOCKING CLIP FOR PUMP WITH CIRCUIT	4.000	PC																																														
KVL1182A	ONE 1ROT CLEANING SYSTEM KIT (0311 EXC.)	<table border="1"> <thead> <tr> <th>Code</th> <th>Description</th> <th>Qty</th> <th>UOM</th> </tr> </thead> <tbody> <tr> <td>0H2202A1</td> <td>ONE WASHING WITH STEAM VALVE SUPPORT</td> <td>1.000</td> <td>PC</td> </tr> <tr> <td>EL1440A0</td> <td>WATER SELF CLEANING VALVE</td> <td>1.000</td> <td>PC</td> </tr> <tr> <td>GN1526A0</td> <td>INT. D.=6.9 TH=1.8 O-RIN</td> <td>3.000</td> <td>PC</td> </tr> <tr> <td>RC1019A0</td> <td>D=10 ELASTIC CLAMP</td> <td>12.000</td> <td>PC</td> </tr> <tr> <td>RC1242A0</td> <td>D=10 CLOSED CAP</td> <td>2.000</td> <td>PC</td> </tr> <tr> <td>RC1414A1</td> <td>D11.5-12.5 SINGLE EAR HOSE CLAMP</td> <td>1.000</td> <td>PC</td> </tr> <tr> <td>TB2821A0</td> <td>EPDM 6X10 L=40MM PIPE</td> <td>4.000</td> <td>PC</td> </tr> </tbody> </table>	Code	Description	Qty	UOM	0H2202A1	ONE WASHING WITH STEAM VALVE SUPPORT	1.000	PC	EL1440A0	WATER SELF CLEANING VALVE	1.000	PC	GN1526A0	INT. D.=6.9 TH=1.8 O-RIN	3.000	PC	RC1019A0	D=10 ELASTIC CLAMP	12.000	PC	RC1242A0	D=10 CLOSED CAP	2.000	PC	RC1414A1	D11.5-12.5 SINGLE EAR HOSE CLAMP	1.000	PC	TB2821A0	EPDM 6X10 L=40MM PIPE	4.000	PC															
Code	Description	Qty	UOM																																														
0H2202A1	ONE WASHING WITH STEAM VALVE SUPPORT	1.000	PC																																														
EL1440A0	WATER SELF CLEANING VALVE	1.000	PC																																														
GN1526A0	INT. D.=6.9 TH=1.8 O-RIN	3.000	PC																																														
RC1019A0	D=10 ELASTIC CLAMP	12.000	PC																																														
RC1242A0	D=10 CLOSED CAP	2.000	PC																																														
RC1414A1	D11.5-12.5 SINGLE EAR HOSE CLAMP	1.000	PC																																														
TB2821A0	EPDM 6X10 L=40MM PIPE	4.000	PC																																														





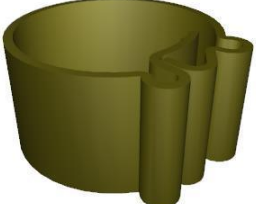

COMPONENT			SPARE PART																																																																																	
Code	Description	Image	Code	Description	Kit components																																																																															
EL1440A	WATER SELF CLEANING VALVE		KVL1182A	ONE 1ROT CLEANING SYSTEM KIT (0311 EXC.)	<table border="1"> <thead> <tr> <th>Code</th> <th>Description</th> <th>Qty</th> <th>UOM</th> </tr> </thead> <tbody> <tr> <td>TB3004A0</td> <td>TB2820A L=550mm EPDM BLACK PIPE</td> <td>1.000</td> <td>PC</td> </tr> <tr> <td>TB3009B0</td> <td>TB3132A-ONE OVEN WASHING INLET</td> <td>1.000</td> <td>PC</td> </tr> <tr> <td>TB3225B0</td> <td>TB2820A-TAN K-WASHYNG SYS CONNECTION</td> <td>1.000</td> <td>PC</td> </tr> <tr> <td>TB3614A0</td> <td>TB3614A0</td> <td>1.000</td> <td>PC</td> </tr> <tr> <td>VI1220A1</td> <td>4,2x12 TCB SELF-TAPPIN G SCREW</td> <td>2.000</td> <td>PC</td> </tr> <tr> <td>VL1019A0</td> <td>VIBRATION DETERGENT PUMP</td> <td>1.000</td> <td>PC</td> </tr> <tr> <td>VL1047A1</td> <td>D6 PIPE HOLDER - D8 J.G. TERMINAL</td> <td>1.000</td> <td>PC</td> </tr> <tr> <td>VL1054B0</td> <td>ONE WASHING SYS INLET DISTRIBUTOR</td> <td>1.000</td> <td>PC</td> </tr> <tr> <td>VL1102A1</td> <td>DETERGENT LINE FILTER + BARBED VNR 6 MM</td> <td>1.000</td> <td>PC</td> </tr> <tr> <td>VL1128A1</td> <td>D6 BARBED CHECK VALVE</td> <td>1.000</td> <td>PC</td> </tr> <tr> <td>VL1166A0</td> <td>BB6-AR6 L FITTING</td> <td>1.000</td> <td>PC</td> </tr> <tr> <td>VL1174C0</td> <td>D1.2 MM CALIBRATED NOZZLE</td> <td>1.000</td> <td>PC</td> </tr> <tr> <td>VL1191A0</td> <td>ONE WASHING DISTRIBUTOR OUTLETS KIT</td> <td>1.000</td> <td>PC</td> </tr> <tr> <td>VL1214A0</td> <td>BAYONET - 6mm BARBED NRV VALVE</td> <td>1.000</td> <td>PC</td> </tr> <tr> <td>VM2172A0</td> <td>LOCKING CLIP FOR PUMP WITH CIRCUIT</td> <td>2.000</td> <td>PC</td> </tr> </tbody> </table>	Code	Description	Qty	UOM	TB3004A0	TB2820A L=550mm EPDM BLACK PIPE	1.000	PC	TB3009B0	TB3132A-ONE OVEN WASHING INLET	1.000	PC	TB3225B0	TB2820A-TAN K-WASHYNG SYS CONNECTION	1.000	PC	TB3614A0	TB3614A0	1.000	PC	VI1220A1	4,2x12 TCB SELF-TAPPIN G SCREW	2.000	PC	VL1019A0	VIBRATION DETERGENT PUMP	1.000	PC	VL1047A1	D6 PIPE HOLDER - D8 J.G. TERMINAL	1.000	PC	VL1054B0	ONE WASHING SYS INLET DISTRIBUTOR	1.000	PC	VL1102A1	DETERGENT LINE FILTER + BARBED VNR 6 MM	1.000	PC	VL1128A1	D6 BARBED CHECK VALVE	1.000	PC	VL1166A0	BB6-AR6 L FITTING	1.000	PC	VL1174C0	D1.2 MM CALIBRATED NOZZLE	1.000	PC	VL1191A0	ONE WASHING DISTRIBUTOR OUTLETS KIT	1.000	PC	VL1214A0	BAYONET - 6mm BARBED NRV VALVE	1.000	PC	VM2172A0	LOCKING CLIP FOR PUMP WITH CIRCUIT	2.000	PC	KEL1440A	SELF CLEANING WATER VALVE KIT	<table border="1"> <thead> <tr> <th>Code</th> <th>Description</th> <th>Qty</th> <th>UOM</th> </tr> </thead> <tbody> <tr> <td>EL1440A0</td> <td>WATER SELF CLEANING VALVE</td> <td>1.000</td> <td>PC</td> </tr> <tr> <td>GN1526A0</td> <td>INT. D.=6.9 TH=1.8 O-RIN</td> <td>2.000</td> <td>PC</td> </tr> </tbody> </table>	Code	Description	Qty	UOM	EL1440A0	WATER SELF CLEANING VALVE	1.000	PC	GN1526A0	INT. D.=6.9 TH=1.8 O-RIN	2.000	PC
			Code	Description	Qty	UOM																																																																														
TB3004A0	TB2820A L=550mm EPDM BLACK PIPE	1.000	PC																																																																																	
TB3009B0	TB3132A-ONE OVEN WASHING INLET	1.000	PC																																																																																	
TB3225B0	TB2820A-TAN K-WASHYNG SYS CONNECTION	1.000	PC																																																																																	
TB3614A0	TB3614A0	1.000	PC																																																																																	
VI1220A1	4,2x12 TCB SELF-TAPPIN G SCREW	2.000	PC																																																																																	
VL1019A0	VIBRATION DETERGENT PUMP	1.000	PC																																																																																	
VL1047A1	D6 PIPE HOLDER - D8 J.G. TERMINAL	1.000	PC																																																																																	
VL1054B0	ONE WASHING SYS INLET DISTRIBUTOR	1.000	PC																																																																																	
VL1102A1	DETERGENT LINE FILTER + BARBED VNR 6 MM	1.000	PC																																																																																	
VL1128A1	D6 BARBED CHECK VALVE	1.000	PC																																																																																	
VL1166A0	BB6-AR6 L FITTING	1.000	PC																																																																																	
VL1174C0	D1.2 MM CALIBRATED NOZZLE	1.000	PC																																																																																	
VL1191A0	ONE WASHING DISTRIBUTOR OUTLETS KIT	1.000	PC																																																																																	
VL1214A0	BAYONET - 6mm BARBED NRV VALVE	1.000	PC																																																																																	
VM2172A0	LOCKING CLIP FOR PUMP WITH CIRCUIT	2.000	PC																																																																																	
Code	Description	Qty	UOM																																																																																	
EL1440A0	WATER SELF CLEANING VALVE	1.000	PC																																																																																	
GN1526A0	INT. D.=6.9 TH=1.8 O-RIN	2.000	PC																																																																																	



COMPONENT			SPARE PART														
Code	Description	Image	Code	Description	Kit components												
EL1440A	WATER SELF CLEANING VALVE		KEL1440A	SELF CLEANING WATER VALVE KIT	<table border="1"> <thead> <tr> <th>Code</th> <th>Description</th> <th>Qty</th> <th>UOM</th> </tr> </thead> <tbody> <tr> <td>RC1131A0</td> <td>200x2.6 BLACK CLAMP</td> <td>1.000</td> <td>PC</td> </tr> <tr> <td>VM2172A0</td> <td>LOCKING CLIP FOR PUMP WITH CIRCUIT</td> <td>1.000</td> <td>PC</td> </tr> </tbody> </table>	Code	Description	Qty	UOM	RC1131A0	200x2.6 BLACK CLAMP	1.000	PC	VM2172A0	LOCKING CLIP FOR PUMP WITH CIRCUIT	1.000	PC
Code	Description	Qty	UOM														
RC1131A0	200x2.6 BLACK CLAMP	1.000	PC														
VM2172A0	LOCKING CLIP FOR PUMP WITH CIRCUIT	1.000	PC														
GN1526A	INT. D.=6.9 TH=1.8 O-RING		KGN1526A	O-RING INT D6.9 THICK1.8 10PCS KIT	<table border="1"> <thead> <tr> <th>Code</th> <th>Description</th> <th>Qty</th> <th>UOM</th> </tr> </thead> <tbody> <tr> <td>GN1526A0</td> <td>INT. D.=6.9 TH=1.8 O-RIN</td> <td>10.000</td> <td>PC</td> </tr> </tbody> </table>	Code	Description	Qty	UOM	GN1526A0	INT. D.=6.9 TH=1.8 O-RIN	10.000	PC				
Code	Description	Qty	UOM														
GN1526A0	INT. D.=6.9 TH=1.8 O-RIN	10.000	PC														
RC1019A	D=10 ELASTIC CLAM		KRC1019A	Ø10 ZINC PLATED ELASTIC CLAMP 15 PCS KIT	<table border="1"> <thead> <tr> <th>Code</th> <th>Description</th> <th>Qty</th> <th>UOM</th> </tr> </thead> <tbody> <tr> <td>RC1019A0</td> <td>D=10 ELASTIC CLAMP</td> <td>15.000</td> <td>PC</td> </tr> </tbody> </table>	Code	Description	Qty	UOM	RC1019A0	D=10 ELASTIC CLAMP	15.000	PC				
Code	Description	Qty	UOM														
RC1019A0	D=10 ELASTIC CLAMP	15.000	PC														
RC1414A	D12 HOSE CLAMP		KRC1414A	D11-12 HOSE SNAP CLAMP 10 PCS KIT	<table border="1"> <thead> <tr> <th>Code</th> <th>Description</th> <th>Qty</th> <th>UOM</th> </tr> </thead> <tbody> <tr> <td>RC1414A1</td> <td>D11.5-12.5 SINGLE EAR HOSE CLAMP</td> <td>50.000</td> <td>PC</td> </tr> </tbody> </table>	Code	Description	Qty	UOM	RC1414A1	D11.5-12.5 SINGLE EAR HOSE CLAMP	50.000	PC				
Code	Description	Qty	UOM														
RC1414A1	D11.5-12.5 SINGLE EAR HOSE CLAMP	50.000	PC														
TB3004A	TB2820A L=550mm EPDM BLACK PIPE		KTB1343A	TB2820A0 6x10 EPM DETERGENT PIPE 3M KIT	<table border="1"> <thead> <tr> <th>Code</th> <th>Description</th> <th>Qty</th> <th>UOM</th> </tr> </thead> <tbody> <tr> <td>TB2820A0</td> <td>6X10 EPDM PIPE FOR WASHING SYSTEM</td> <td>3.000</td> <td>M</td> </tr> </tbody> </table>	Code	Description	Qty	UOM	TB2820A0	6X10 EPDM PIPE FOR WASHING SYSTEM	3.000	M				
Code	Description	Qty	UOM														
TB2820A0	6X10 EPDM PIPE FOR WASHING SYSTEM	3.000	M														



COMPONENT			SPARE PART																																		
Code	Description	Image	Code	Description	Kit components																																
TB3005B	TB3132A L=550mm EPDM WHITE-BLUE PIPE		KTB3132A	WHITE-BLU 6X12 REINFORCED PIPE 3M KIT	<table border="1"> <thead> <tr> <th>Code</th> <th>Description</th> <th>Qty</th> <th>UOM</th> </tr> </thead> <tbody> <tr> <td>TB3132A0</td> <td>WHITE-BLUE EPDM TEXTILE BRAID HOSE 6x12</td> <td>3.000</td> <td>M</td> </tr> </tbody> </table>	Code	Description	Qty	UOM	TB3132A0	WHITE-BLUE EPDM TEXTILE BRAID HOSE 6x12	3.000	M																								
Code	Description	Qty	UOM																																		
TB3132A0	WHITE-BLUE EPDM TEXTILE BRAID HOSE 6x12	3.000	M																																		
TB3225B	TB2820A-TANK-WAS HYNG SYS CONNECTION		KTB1343A	TB2820A0 6x10 EPM DETERGENT PIPE 3M KIT	<table border="1"> <thead> <tr> <th>Code</th> <th>Description</th> <th>Qty</th> <th>UOM</th> </tr> </thead> <tbody> <tr> <td>TB2820A0</td> <td>6X10 EPDM PIPE FOR WASHING SYSTEM</td> <td>3.000</td> <td>M</td> </tr> </tbody> </table>	Code	Description	Qty	UOM	TB2820A0	6X10 EPDM PIPE FOR WASHING SYSTEM	3.000	M																								
Code	Description	Qty	UOM																																		
TB2820A0	6X10 EPDM PIPE FOR WASHING SYSTEM	3.000	M																																		
VL1102A	DETERGENT LINE FILTER + BARBED VNR 6 MM		KVL1102A	DETERGENT FILTER + NRV KIT	<table border="1"> <thead> <tr> <th>Code</th> <th>Description</th> <th>Qty</th> <th>UOM</th> </tr> </thead> <tbody> <tr> <td>RC1019A0</td> <td>D=10 ELASTIC CLAMP</td> <td>5.000</td> <td>PC</td> </tr> <tr> <td>TB2820A0</td> <td>6X10 EPDM PIPE FOR WASHING SYSTEM</td> <td>0.040</td> <td>M</td> </tr> <tr> <td>VL1102A1</td> <td>DETERGENT LINE FILTER + BARBED VNR 6 MM</td> <td>1.000</td> <td>PC</td> </tr> </tbody> </table>	Code	Description	Qty	UOM	RC1019A0	D=10 ELASTIC CLAMP	5.000	PC	TB2820A0	6X10 EPDM PIPE FOR WASHING SYSTEM	0.040	M	VL1102A1	DETERGENT LINE FILTER + BARBED VNR 6 MM	1.000	PC																
Code	Description	Qty	UOM																																		
RC1019A0	D=10 ELASTIC CLAMP	5.000	PC																																		
TB2820A0	6X10 EPDM PIPE FOR WASHING SYSTEM	0.040	M																																		
VL1102A1	DETERGENT LINE FILTER + BARBED VNR 6 MM	1.000	PC																																		
VL1166A	BB6-AR6 L FITTING		KVL2618A	2 ROTOR ARMS ONE CLEANING SYSTEM KIT	<table border="1"> <thead> <tr> <th>Code</th> <th>Description</th> <th>Qty</th> <th>UOM</th> </tr> </thead> <tbody> <tr> <td>0H2202A1</td> <td>ONE WASHING WITH STEAM VALVE SUPPORT</td> <td>2.000</td> <td>PC</td> </tr> <tr> <td>CE1030A0</td> <td>FEMALE FASTON COVER 6.3X0.8 0.5-1mmq</td> <td>4.000</td> <td>PC</td> </tr> <tr> <td>CE1395A0</td> <td>6,3 X 0,8 iMALE FASTO</td> <td>2.000</td> <td>PC</td> </tr> <tr> <td>CE1545A0</td> <td>BLUE UNIP AWG18 ST.3135 WIRE</td> <td>2.000</td> <td>M</td> </tr> <tr> <td>CE1570A0</td> <td>WHITE UNIP AWG18 ST.3135 WIRE</td> <td>2.000</td> <td>M</td> </tr> <tr> <td>CE1660A0</td> <td>6,3x0,8 FEMALE FASTON COVE</td> <td>4.000</td> <td>PC</td> </tr> <tr> <td>CE1661A0</td> <td>MALE FASTON COVER 6,3x0,8</td> <td>2.000</td> <td>PC</td> </tr> </tbody> </table>	Code	Description	Qty	UOM	0H2202A1	ONE WASHING WITH STEAM VALVE SUPPORT	2.000	PC	CE1030A0	FEMALE FASTON COVER 6.3X0.8 0.5-1mmq	4.000	PC	CE1395A0	6,3 X 0,8 iMALE FASTO	2.000	PC	CE1545A0	BLUE UNIP AWG18 ST.3135 WIRE	2.000	M	CE1570A0	WHITE UNIP AWG18 ST.3135 WIRE	2.000	M	CE1660A0	6,3x0,8 FEMALE FASTON COVE	4.000	PC	CE1661A0	MALE FASTON COVER 6,3x0,8	2.000	PC
Code	Description	Qty	UOM																																		
0H2202A1	ONE WASHING WITH STEAM VALVE SUPPORT	2.000	PC																																		
CE1030A0	FEMALE FASTON COVER 6.3X0.8 0.5-1mmq	4.000	PC																																		
CE1395A0	6,3 X 0,8 iMALE FASTO	2.000	PC																																		
CE1545A0	BLUE UNIP AWG18 ST.3135 WIRE	2.000	M																																		
CE1570A0	WHITE UNIP AWG18 ST.3135 WIRE	2.000	M																																		
CE1660A0	6,3x0,8 FEMALE FASTON COVE	4.000	PC																																		
CE1661A0	MALE FASTON COVER 6,3x0,8	2.000	PC																																		



COMPONENT			SPARE PART																																																																															
Code	Description	Image	Code	Description	Kit components																																																																													
VL1166A	BB6-AR6 L FITTING		KVL2618A	2 ROTOR ARMS ONE CLEANING SYSTEM KIT	<table border="1"> <thead> <tr> <th>Code</th> <th>Description</th> <th>Qty</th> <th>UOM</th> </tr> </thead> <tbody> <tr> <td>EL1020A1</td> <td>D8 INTERMEDIAT E T-SHAPED FITTING</td> <td>1.000</td> <td>PC</td> </tr> <tr> <td>EL1440A0</td> <td>WATER SELF CLEANING VALVE</td> <td>2.000</td> <td>PC</td> </tr> <tr> <td>GN1526A0</td> <td>INT. D.=6.9 TH=1.8 O-RIN</td> <td>6.000</td> <td>PC</td> </tr> <tr> <td>RC1018A0</td> <td>ZINC PLATED D12 ELASTIC CLAMP</td> <td>2.000</td> <td>PC</td> </tr> <tr> <td>RC1019A0</td> <td>D=10 ELASTIC CLAMP</td> <td>28.000</td> <td>PC</td> </tr> <tr> <td>RC1130A0</td> <td>130x2,6 CLAM</td> <td>4.000</td> <td>PC</td> </tr> <tr> <td>RC1242A0</td> <td>D=10 CLOSED CAP</td> <td>4.000</td> <td>PC</td> </tr> <tr> <td>RC1414A1</td> <td>D11,5-12,5 SINGLE EAR HOSE CLAMP</td> <td>5.000</td> <td>PC</td> </tr> <tr> <td>TB2821A0</td> <td>EPDM 6X10 L=40MM PIPE</td> <td>12.000</td> <td>PC</td> </tr> <tr> <td>TB3004A0</td> <td>TB2820A L=550mm EPDM BLACK PIPE</td> <td>2.000</td> <td>PC</td> </tr> <tr> <td>TB3009B0</td> <td>TB3132A-ONE OVEN WASHING INLET</td> <td>2.000</td> <td>PC</td> </tr> <tr> <td>TB3225B0</td> <td>TB2820A-TAN K-WASHYNG SYS CONNECTION</td> <td>2.000</td> <td>PC</td> </tr> <tr> <td>VI1220A1</td> <td>4,2x12 TCB SELF-TAPPIN G SCREW</td> <td>2.000</td> <td>PC</td> </tr> <tr> <td>VL1019A0</td> <td>VIBRATION DETERGENT PUMP</td> <td>2.000</td> <td>PC</td> </tr> <tr> <td>VL1047A1</td> <td>D6 PIPE HOLDER - D8 J.G. TERMINAL</td> <td>2.000</td> <td>PC</td> </tr> <tr> <td>VL1054B0</td> <td>ONE WASHING SYS INLET DISTRIBUTOR</td> <td>2.000</td> <td>PC</td> </tr> <tr> <td>VL1102A1</td> <td>DETERGENT LINE FILTER + BARBED VNR 6 MM</td> <td>2.000</td> <td>PC</td> </tr> <tr> <td>VL1127A1</td> <td>6mm BARBED T-SHAPED FITTING</td> <td>1.000</td> <td>PC</td> </tr> </tbody> </table>	Code	Description	Qty	UOM	EL1020A1	D8 INTERMEDIAT E T-SHAPED FITTING	1.000	PC	EL1440A0	WATER SELF CLEANING VALVE	2.000	PC	GN1526A0	INT. D.=6.9 TH=1.8 O-RIN	6.000	PC	RC1018A0	ZINC PLATED D12 ELASTIC CLAMP	2.000	PC	RC1019A0	D=10 ELASTIC CLAMP	28.000	PC	RC1130A0	130x2,6 CLAM	4.000	PC	RC1242A0	D=10 CLOSED CAP	4.000	PC	RC1414A1	D11,5-12,5 SINGLE EAR HOSE CLAMP	5.000	PC	TB2821A0	EPDM 6X10 L=40MM PIPE	12.000	PC	TB3004A0	TB2820A L=550mm EPDM BLACK PIPE	2.000	PC	TB3009B0	TB3132A-ONE OVEN WASHING INLET	2.000	PC	TB3225B0	TB2820A-TAN K-WASHYNG SYS CONNECTION	2.000	PC	VI1220A1	4,2x12 TCB SELF-TAPPIN G SCREW	2.000	PC	VL1019A0	VIBRATION DETERGENT PUMP	2.000	PC	VL1047A1	D6 PIPE HOLDER - D8 J.G. TERMINAL	2.000	PC	VL1054B0	ONE WASHING SYS INLET DISTRIBUTOR	2.000	PC	VL1102A1	DETERGENT LINE FILTER + BARBED VNR 6 MM	2.000	PC	VL1127A1	6mm BARBED T-SHAPED FITTING	1.000	PC	
Code	Description	Qty	UOM																																																																															
EL1020A1	D8 INTERMEDIAT E T-SHAPED FITTING	1.000	PC																																																																															
EL1440A0	WATER SELF CLEANING VALVE	2.000	PC																																																																															
GN1526A0	INT. D.=6.9 TH=1.8 O-RIN	6.000	PC																																																																															
RC1018A0	ZINC PLATED D12 ELASTIC CLAMP	2.000	PC																																																																															
RC1019A0	D=10 ELASTIC CLAMP	28.000	PC																																																																															
RC1130A0	130x2,6 CLAM	4.000	PC																																																																															
RC1242A0	D=10 CLOSED CAP	4.000	PC																																																																															
RC1414A1	D11,5-12,5 SINGLE EAR HOSE CLAMP	5.000	PC																																																																															
TB2821A0	EPDM 6X10 L=40MM PIPE	12.000	PC																																																																															
TB3004A0	TB2820A L=550mm EPDM BLACK PIPE	2.000	PC																																																																															
TB3009B0	TB3132A-ONE OVEN WASHING INLET	2.000	PC																																																																															
TB3225B0	TB2820A-TAN K-WASHYNG SYS CONNECTION	2.000	PC																																																																															
VI1220A1	4,2x12 TCB SELF-TAPPIN G SCREW	2.000	PC																																																																															
VL1019A0	VIBRATION DETERGENT PUMP	2.000	PC																																																																															
VL1047A1	D6 PIPE HOLDER - D8 J.G. TERMINAL	2.000	PC																																																																															
VL1054B0	ONE WASHING SYS INLET DISTRIBUTOR	2.000	PC																																																																															
VL1102A1	DETERGENT LINE FILTER + BARBED VNR 6 MM	2.000	PC																																																																															
VL1127A1	6mm BARBED T-SHAPED FITTING	1.000	PC																																																																															



COMPONENT			SPARE PART																																																																		
Code	Description	Image	Code	Description	Kit components																																																																
VL1166A	BB6-AR6 L FITTING		KVL2618A	2 ROTOR ARMS ONE CLEANING SYSTEM KIT	<table border="1"> <thead> <tr> <th>Code</th> <th>Description</th> <th>Qty</th> <th>UOM</th> </tr> </thead> <tbody> <tr> <td>VL1128A1</td> <td>D6 BARBED CHECK VALVE</td> <td>4.000</td> <td>PC</td> </tr> <tr> <td>VL1166A0</td> <td>BB6-AR6 L FITTING</td> <td>2.000</td> <td>PC</td> </tr> <tr> <td>VL1174C0</td> <td>D1.2 MM CALIBRATED NOZZLE</td> <td>2.000</td> <td>PC</td> </tr> <tr> <td>VL1191A0</td> <td>ONE WASHING DISTRIBUTOR OUTLETS KIT</td> <td>2.000</td> <td>PC</td> </tr> <tr> <td>VL1214A0</td> <td>BAYONET - 6mm BARBED NRV VALVE</td> <td>2.000</td> <td>PC</td> </tr> <tr> <td>VM2172A0</td> <td>LOCKING CLIP FOR PUMP WITH CIRCUIT</td> <td>4.000</td> <td>PC</td> </tr> </tbody> </table>	Code	Description	Qty	UOM	VL1128A1	D6 BARBED CHECK VALVE	4.000	PC	VL1166A0	BB6-AR6 L FITTING	2.000	PC	VL1174C0	D1.2 MM CALIBRATED NOZZLE	2.000	PC	VL1191A0	ONE WASHING DISTRIBUTOR OUTLETS KIT	2.000	PC	VL1214A0	BAYONET - 6mm BARBED NRV VALVE	2.000	PC	VM2172A0	LOCKING CLIP FOR PUMP WITH CIRCUIT	4.000	PC																																				
Code	Description	Qty	UOM																																																																		
VL1128A1	D6 BARBED CHECK VALVE	4.000	PC																																																																		
VL1166A0	BB6-AR6 L FITTING	2.000	PC																																																																		
VL1174C0	D1.2 MM CALIBRATED NOZZLE	2.000	PC																																																																		
VL1191A0	ONE WASHING DISTRIBUTOR OUTLETS KIT	2.000	PC																																																																		
VL1214A0	BAYONET - 6mm BARBED NRV VALVE	2.000	PC																																																																		
VM2172A0	LOCKING CLIP FOR PUMP WITH CIRCUIT	4.000	PC																																																																		
			KVL1225A	US HOOD WASHING SYSTEM KIT	<table border="1"> <thead> <tr> <th>Code</th> <th>Description</th> <th>Qty</th> <th>UOM</th> </tr> </thead> <tbody> <tr> <td>0H2213A1</td> <td>HOOD WATER CIRCUIT PLAT</td> <td>1.000</td> <td>PC</td> </tr> <tr> <td>EL1450A0</td> <td>US SELF-CLEANIN G WATER SOLENOID</td> <td>2.000</td> <td>PC</td> </tr> <tr> <td>GN1526A0</td> <td>INT. D.=6.9 TH=1.8 O-RIN</td> <td>5.000</td> <td>PC</td> </tr> <tr> <td>RC1019A0</td> <td>D=10 ELASTIC CLAMP</td> <td>14.000</td> <td>PC</td> </tr> <tr> <td>RC1131A0</td> <td>200x2.6 BLACK CLAMP</td> <td>1.000</td> <td>PC</td> </tr> <tr> <td>RC1242A0</td> <td>D=10 CLOSED CAP</td> <td>2.000</td> <td>PC</td> </tr> <tr> <td>RC1414A1</td> <td>D11.5-12.5 SINGLE EAR HOSE CLAMP</td> <td>4.000</td> <td>PC</td> </tr> <tr> <td>TB2821A0</td> <td>EPDM 6X10 L=40MM PIPE</td> <td>4.000</td> <td>PC</td> </tr> <tr> <td>TB2994A0</td> <td>HOOD DETERGENT PIPE</td> <td>2.000</td> <td>PC</td> </tr> <tr> <td>TB3252A0</td> <td>TB3252A0</td> <td>2.000</td> <td>PC</td> </tr> <tr> <td>TB3614A0</td> <td>TB3614A0</td> <td>1.000</td> <td>PC</td> </tr> <tr> <td>VI1220A1</td> <td>4,2x12 TCB SELF-TAPPIN G SCREW</td> <td>3.000</td> <td>PC</td> </tr> <tr> <td>VI2070A0</td> <td>SHEETTRACS TCB+ 40x8 SELF-THREAD SCREW</td> <td>2.000</td> <td>PC</td> </tr> <tr> <td>VL1019A0</td> <td>VIBRATION DETERGENT PUMP</td> <td>1.000</td> <td>PC</td> </tr> <tr> <td>VL1047A1</td> <td>D6 PIPE HOLDER - D8 J.G. TERMINAL</td> <td>1.000</td> <td>PC</td> </tr> </tbody> </table>	Code	Description	Qty	UOM	0H2213A1	HOOD WATER CIRCUIT PLAT	1.000	PC	EL1450A0	US SELF-CLEANIN G WATER SOLENOID	2.000	PC	GN1526A0	INT. D.=6.9 TH=1.8 O-RIN	5.000	PC	RC1019A0	D=10 ELASTIC CLAMP	14.000	PC	RC1131A0	200x2.6 BLACK CLAMP	1.000	PC	RC1242A0	D=10 CLOSED CAP	2.000	PC	RC1414A1	D11.5-12.5 SINGLE EAR HOSE CLAMP	4.000	PC	TB2821A0	EPDM 6X10 L=40MM PIPE	4.000	PC	TB2994A0	HOOD DETERGENT PIPE	2.000	PC	TB3252A0	TB3252A0	2.000	PC	TB3614A0	TB3614A0	1.000	PC	VI1220A1	4,2x12 TCB SELF-TAPPIN G SCREW	3.000	PC	VI2070A0	SHEETTRACS TCB+ 40x8 SELF-THREAD SCREW	2.000	PC	VL1019A0	VIBRATION DETERGENT PUMP	1.000	PC	VL1047A1	D6 PIPE HOLDER - D8 J.G. TERMINAL	1.000	PC
Code	Description	Qty	UOM																																																																		
0H2213A1	HOOD WATER CIRCUIT PLAT	1.000	PC																																																																		
EL1450A0	US SELF-CLEANIN G WATER SOLENOID	2.000	PC																																																																		
GN1526A0	INT. D.=6.9 TH=1.8 O-RIN	5.000	PC																																																																		
RC1019A0	D=10 ELASTIC CLAMP	14.000	PC																																																																		
RC1131A0	200x2.6 BLACK CLAMP	1.000	PC																																																																		
RC1242A0	D=10 CLOSED CAP	2.000	PC																																																																		
RC1414A1	D11.5-12.5 SINGLE EAR HOSE CLAMP	4.000	PC																																																																		
TB2821A0	EPDM 6X10 L=40MM PIPE	4.000	PC																																																																		
TB2994A0	HOOD DETERGENT PIPE	2.000	PC																																																																		
TB3252A0	TB3252A0	2.000	PC																																																																		
TB3614A0	TB3614A0	1.000	PC																																																																		
VI1220A1	4,2x12 TCB SELF-TAPPIN G SCREW	3.000	PC																																																																		
VI2070A0	SHEETTRACS TCB+ 40x8 SELF-THREAD SCREW	2.000	PC																																																																		
VL1019A0	VIBRATION DETERGENT PUMP	1.000	PC																																																																		
VL1047A1	D6 PIPE HOLDER - D8 J.G. TERMINAL	1.000	PC																																																																		



COMPONENT			SPARE PART																																																																																					
Code	Description	Image	Code	Description	Kit components																																																																																			
VL1166A	BB6-AR6 L FITTING		KVL1225A	US HOOD WASHING SYSTEM KIT	<table border="1"> <thead> <tr> <th>Code</th> <th>Description</th> <th>Qty</th> <th>UOM</th> </tr> </thead> <tbody> <tr> <td>VL1054B0</td> <td>ONE WASHING SYS INLET DISTRIBUTOR</td> <td>1.000</td> <td>PC</td> </tr> <tr> <td>VL1102A1</td> <td>DETERGENT LINE FILTER + BARBED VNR 6 MM</td> <td>1.000</td> <td>PC</td> </tr> <tr> <td>VL1127A1</td> <td>6mm BARBED T-SHAPED FITTING</td> <td>1.000</td> <td>PC</td> </tr> <tr> <td>VL1128A1</td> <td>D6 BARBED CHECK VALVE</td> <td>1.000</td> <td>PC</td> </tr> <tr> <td>VL1165A0</td> <td>BAM-BB6 STRAIGHT FITTING</td> <td>1.000</td> <td>PC</td> </tr> <tr> <td>VL1166A0</td> <td>BB6-AR6 L FITTING</td> <td>2.000</td> <td>PC</td> </tr> <tr> <td>VL1174C0</td> <td>D1.2 MM CALIBRATED NOZZLE</td> <td>1.000</td> <td>PC</td> </tr> <tr> <td>VL1191A0</td> <td>ONE WASHING DISTRIBUTOR OUTLETS KIT</td> <td>1.000</td> <td>PC</td> </tr> <tr> <td>VL1214A0</td> <td>BAYONET - 6mm BARBED NRV VALVE</td> <td>1.000</td> <td>PC</td> </tr> <tr> <td>VM1605A0</td> <td>CLIP TWIST LOCK DIAM. 10.2-12.7 MM</td> <td>2.000</td> <td>PC</td> </tr> <tr> <td>VM2172A0</td> <td>LOCKING CLIP FOR PUMP WITH CIRCUIT</td> <td>3.000</td> <td>PC</td> </tr> </tbody> </table>	Code	Description	Qty	UOM	VL1054B0	ONE WASHING SYS INLET DISTRIBUTOR	1.000	PC	VL1102A1	DETERGENT LINE FILTER + BARBED VNR 6 MM	1.000	PC	VL1127A1	6mm BARBED T-SHAPED FITTING	1.000	PC	VL1128A1	D6 BARBED CHECK VALVE	1.000	PC	VL1165A0	BAM-BB6 STRAIGHT FITTING	1.000	PC	VL1166A0	BB6-AR6 L FITTING	2.000	PC	VL1174C0	D1.2 MM CALIBRATED NOZZLE	1.000	PC	VL1191A0	ONE WASHING DISTRIBUTOR OUTLETS KIT	1.000	PC	VL1214A0	BAYONET - 6mm BARBED NRV VALVE	1.000	PC	VM1605A0	CLIP TWIST LOCK DIAM. 10.2-12.7 MM	2.000	PC	VM2172A0	LOCKING CLIP FOR PUMP WITH CIRCUIT	3.000	PC	KVL1222A	EUR 0311 ONE PLUS CLEANING SYSTEM KIT	<table border="1"> <thead> <tr> <th>Code</th> <th>Description</th> <th>Qty</th> <th>UOM</th> </tr> </thead> <tbody> <tr> <td>0H2486A0</td> <td>0311 WASHING CIRCUIT PLAT</td> <td>1.000</td> <td>PC</td> </tr> <tr> <td>EL1440A0</td> <td>WATER SELF CLEANING VALVE</td> <td>1.000</td> <td>PC</td> </tr> <tr> <td>GN1526A0</td> <td>INT. D.=6.9 TH=1.8 O-RIN</td> <td>3.000</td> <td>PC</td> </tr> <tr> <td>RC1019A0</td> <td>D=10 ELASTIC CLAMP</td> <td>12.000</td> <td>PC</td> </tr> <tr> <td>RC1242A0</td> <td>D=10 CLOSED CAP</td> <td>2.000</td> <td>PC</td> </tr> <tr> <td>RC1414A1</td> <td>D11.5-12.5 SINGLE EAR HOSE CLAMP</td> <td>1.000</td> <td>PC</td> </tr> <tr> <td>TB2821A0</td> <td>EPDM 6X10 L=40MM PIPE</td> <td>4.000</td> <td>PC</td> </tr> </tbody> </table>	Code	Description	Qty	UOM	0H2486A0	0311 WASHING CIRCUIT PLAT	1.000	PC	EL1440A0	WATER SELF CLEANING VALVE	1.000	PC	GN1526A0	INT. D.=6.9 TH=1.8 O-RIN	3.000	PC	RC1019A0	D=10 ELASTIC CLAMP	12.000	PC	RC1242A0	D=10 CLOSED CAP	2.000	PC	RC1414A1	D11.5-12.5 SINGLE EAR HOSE CLAMP	1.000	PC	TB2821A0	EPDM 6X10 L=40MM PIPE	4.000	PC
			Code		Description	Qty	UOM																																																																																	
VL1054B0	ONE WASHING SYS INLET DISTRIBUTOR	1.000	PC																																																																																					
VL1102A1	DETERGENT LINE FILTER + BARBED VNR 6 MM	1.000	PC																																																																																					
VL1127A1	6mm BARBED T-SHAPED FITTING	1.000	PC																																																																																					
VL1128A1	D6 BARBED CHECK VALVE	1.000	PC																																																																																					
VL1165A0	BAM-BB6 STRAIGHT FITTING	1.000	PC																																																																																					
VL1166A0	BB6-AR6 L FITTING	2.000	PC																																																																																					
VL1174C0	D1.2 MM CALIBRATED NOZZLE	1.000	PC																																																																																					
VL1191A0	ONE WASHING DISTRIBUTOR OUTLETS KIT	1.000	PC																																																																																					
VL1214A0	BAYONET - 6mm BARBED NRV VALVE	1.000	PC																																																																																					
VM1605A0	CLIP TWIST LOCK DIAM. 10.2-12.7 MM	2.000	PC																																																																																					
VM2172A0	LOCKING CLIP FOR PUMP WITH CIRCUIT	3.000	PC																																																																																					
Code	Description	Qty	UOM																																																																																					
0H2486A0	0311 WASHING CIRCUIT PLAT	1.000	PC																																																																																					
EL1440A0	WATER SELF CLEANING VALVE	1.000	PC																																																																																					
GN1526A0	INT. D.=6.9 TH=1.8 O-RIN	3.000	PC																																																																																					
RC1019A0	D=10 ELASTIC CLAMP	12.000	PC																																																																																					
RC1242A0	D=10 CLOSED CAP	2.000	PC																																																																																					
RC1414A1	D11.5-12.5 SINGLE EAR HOSE CLAMP	1.000	PC																																																																																					
TB2821A0	EPDM 6X10 L=40MM PIPE	4.000	PC																																																																																					





COMPONENT			SPARE PART																																																																							
Code	Description	Image	Code	Description	Kit components																																																																					
VL1166A	BB6-AR6 L FITTING		KVL1222A	EUR 0311 ONE PLUS CLEANING SYSTEM KIT	<table border="1"> <thead> <tr> <th>Code</th> <th>Description</th> <th>Qty</th> <th>UOM</th> </tr> </thead> <tbody> <tr> <td>TB3004A0</td> <td>TB2820A L=550mm EPDM BLACK PIPE</td> <td>1.000</td> <td>PC</td> </tr> <tr> <td>TB3009B0</td> <td>TB3132A-ONE OVEN WASHING INLET</td> <td>1.000</td> <td>PC</td> </tr> <tr> <td>TB3225B0</td> <td>TB2820A-TAN K-WASHYNG SYS CONNECTION</td> <td>1.000</td> <td>PC</td> </tr> <tr> <td>TB3614A0</td> <td>TB3614A0</td> <td>1.000</td> <td>PC</td> </tr> <tr> <td>VI1220A1</td> <td>4,2x12 TCB SELF-TAPPIN G SCREW</td> <td>4.000</td> <td>PC</td> </tr> <tr> <td>VI2070A0</td> <td>SHEETTRACS TCB+ 40x8 SELF-THREAD SCREW</td> <td>2.000</td> <td>PC</td> </tr> <tr> <td>VL1019A0</td> <td>VIBRATION DETERGENT PUMP</td> <td>1.000</td> <td>PC</td> </tr> <tr> <td>VL1047A1</td> <td>D6 PIPE HOLDER - D8 J.G. TERMINAL</td> <td>1.000</td> <td>PC</td> </tr> <tr> <td>VL1054B0</td> <td>ONE WASHING SYS INLET DISTRIBUTOR</td> <td>1.000</td> <td>PC</td> </tr> <tr> <td>VL1102A1</td> <td>DETERGENT LINE FILTER + BARBED VNR 6 MM</td> <td>1.000</td> <td>PC</td> </tr> <tr> <td>VL1128A1</td> <td>D6 BARBED CHECK VALVE</td> <td>1.000</td> <td>PC</td> </tr> <tr> <td>VL1166A0</td> <td>BB6-AR6 L FITTING</td> <td>1.000</td> <td>PC</td> </tr> <tr> <td>VL1174C0</td> <td>D1.2 MM CALIBRATED NOZZLE</td> <td>1.000</td> <td>PC</td> </tr> <tr> <td>VL1191A0</td> <td>ONE WASHING DISTRIBUTOR OUTLETS KIT</td> <td>1.000</td> <td>PC</td> </tr> <tr> <td>VL1214A0</td> <td>BAYONET - 6mm BARBED NRV VALVE</td> <td>1.000</td> <td>PC</td> </tr> <tr> <td>VM2172A0</td> <td>LOCKING CLIP FOR PUMP WITH CIRCUIT</td> <td>2.000</td> <td>PC</td> </tr> </tbody> </table>	Code	Description	Qty	UOM	TB3004A0	TB2820A L=550mm EPDM BLACK PIPE	1.000	PC	TB3009B0	TB3132A-ONE OVEN WASHING INLET	1.000	PC	TB3225B0	TB2820A-TAN K-WASHYNG SYS CONNECTION	1.000	PC	TB3614A0	TB3614A0	1.000	PC	VI1220A1	4,2x12 TCB SELF-TAPPIN G SCREW	4.000	PC	VI2070A0	SHEETTRACS TCB+ 40x8 SELF-THREAD SCREW	2.000	PC	VL1019A0	VIBRATION DETERGENT PUMP	1.000	PC	VL1047A1	D6 PIPE HOLDER - D8 J.G. TERMINAL	1.000	PC	VL1054B0	ONE WASHING SYS INLET DISTRIBUTOR	1.000	PC	VL1102A1	DETERGENT LINE FILTER + BARBED VNR 6 MM	1.000	PC	VL1128A1	D6 BARBED CHECK VALVE	1.000	PC	VL1166A0	BB6-AR6 L FITTING	1.000	PC	VL1174C0	D1.2 MM CALIBRATED NOZZLE	1.000	PC	VL1191A0	ONE WASHING DISTRIBUTOR OUTLETS KIT	1.000	PC	VL1214A0	BAYONET - 6mm BARBED NRV VALVE	1.000	PC	VM2172A0	LOCKING CLIP FOR PUMP WITH CIRCUIT	2.000	PC	
Code	Description	Qty	UOM																																																																							
TB3004A0	TB2820A L=550mm EPDM BLACK PIPE	1.000	PC																																																																							
TB3009B0	TB3132A-ONE OVEN WASHING INLET	1.000	PC																																																																							
TB3225B0	TB2820A-TAN K-WASHYNG SYS CONNECTION	1.000	PC																																																																							
TB3614A0	TB3614A0	1.000	PC																																																																							
VI1220A1	4,2x12 TCB SELF-TAPPIN G SCREW	4.000	PC																																																																							
VI2070A0	SHEETTRACS TCB+ 40x8 SELF-THREAD SCREW	2.000	PC																																																																							
VL1019A0	VIBRATION DETERGENT PUMP	1.000	PC																																																																							
VL1047A1	D6 PIPE HOLDER - D8 J.G. TERMINAL	1.000	PC																																																																							
VL1054B0	ONE WASHING SYS INLET DISTRIBUTOR	1.000	PC																																																																							
VL1102A1	DETERGENT LINE FILTER + BARBED VNR 6 MM	1.000	PC																																																																							
VL1128A1	D6 BARBED CHECK VALVE	1.000	PC																																																																							
VL1166A0	BB6-AR6 L FITTING	1.000	PC																																																																							
VL1174C0	D1.2 MM CALIBRATED NOZZLE	1.000	PC																																																																							
VL1191A0	ONE WASHING DISTRIBUTOR OUTLETS KIT	1.000	PC																																																																							
VL1214A0	BAYONET - 6mm BARBED NRV VALVE	1.000	PC																																																																							
VM2172A0	LOCKING CLIP FOR PUMP WITH CIRCUIT	2.000	PC																																																																							



COMPONENT			SPARE PART																																																																																		
Code	Description	Image	Code	Description	Kit components																																																																																
VL1166A	BB6-AR6 L FITTING		KVL1213A	US PLUS COMPACT WASHING SYSTEM KIT	<table border="1"> <thead> <tr> <th>Code</th> <th>Description</th> <th>Qty</th> <th>UOM</th> </tr> </thead> <tbody> <tr> <td>0H2428A2</td> <td>XECC PLUS WASHING CIRCUIT PLAT</td> <td>1.000</td> <td>PC</td> </tr> <tr> <td>EL1450A0</td> <td>US SELF-CLEANIN G WATER SOLENOID</td> <td>3.000</td> <td>PC</td> </tr> <tr> <td>GN1311A0</td> <td>RUBBER CABLE-PASSI NG Dø=25 Di=12 Th=6,5</td> <td>1.000</td> <td>PC</td> </tr> <tr> <td>GN1526A0</td> <td>INT. D.=6.9 TH=1.8 O-RIN</td> <td>7.000</td> <td>PC</td> </tr> <tr> <td>RC1018A0</td> <td>ZINC PLATED D12 ELASTIC CLAMP</td> <td>5.000</td> <td>PC</td> </tr> <tr> <td>RC1019A0</td> <td>D=10 ELASTIC CLAMP</td> <td>14.000</td> <td>PC</td> </tr> <tr> <td>RC1130A0</td> <td>130x2,6 CLAM</td> <td>1.000</td> <td>PC</td> </tr> <tr> <td>RC1131A0</td> <td>200x2,6 BLACK CLAMP</td> <td>1.000</td> <td>PC</td> </tr> <tr> <td>RC1242A0</td> <td>D=10 CLOSED CAP</td> <td>2.000</td> <td>PC</td> </tr> <tr> <td>RC1356A0</td> <td>*STRAIGHT THREADED FEMALE END 8x1/4" BS</td> <td>1.000</td> <td>PC</td> </tr> <tr> <td>RC1414A1</td> <td>D11.5-12.5 SINGLE EAR HOSE CLAMP</td> <td>4.000</td> <td>PC</td> </tr> <tr> <td>TB2821A0</td> <td>EPDM 6X10 L=40MM PIPE</td> <td>6.000</td> <td>PC</td> </tr> <tr> <td>TB3004A0</td> <td>TB2820A L=550mm EPDM BLACK PIPE</td> <td>2.000</td> <td>PC</td> </tr> <tr> <td>TB3005B0</td> <td>TB3132A L=550mm EPDM WHITE-BLUE PIPE</td> <td>1.000</td> <td>PC</td> </tr> <tr> <td>TB3252A0</td> <td>TB3252A0</td> <td>1.000</td> <td>PC</td> </tr> <tr> <td>TB3469A0</td> <td></td> <td>1.000</td> <td>PC</td> </tr> <tr> <td>VH1220A1</td> <td>4,2x12 TCB SELF-TAPPIN G SCREW</td> <td>3.000</td> <td>PC</td> </tr> <tr> <td>VL1019A0</td> <td>VIBRATION DETERGENT PUMP</td> <td>1.000</td> <td>PC</td> </tr> <tr> <td>VL1047A1</td> <td>D6 PIPE HOLDER - D8 J.G. TERMINAL</td> <td>1.000</td> <td>PC</td> </tr> </tbody> </table>	Code	Description	Qty	UOM	0H2428A2	XECC PLUS WASHING CIRCUIT PLAT	1.000	PC	EL1450A0	US SELF-CLEANIN G WATER SOLENOID	3.000	PC	GN1311A0	RUBBER CABLE-PASSI NG Dø=25 Di=12 Th=6,5	1.000	PC	GN1526A0	INT. D.=6.9 TH=1.8 O-RIN	7.000	PC	RC1018A0	ZINC PLATED D12 ELASTIC CLAMP	5.000	PC	RC1019A0	D=10 ELASTIC CLAMP	14.000	PC	RC1130A0	130x2,6 CLAM	1.000	PC	RC1131A0	200x2,6 BLACK CLAMP	1.000	PC	RC1242A0	D=10 CLOSED CAP	2.000	PC	RC1356A0	*STRAIGHT THREADED FEMALE END 8x1/4" BS	1.000	PC	RC1414A1	D11.5-12.5 SINGLE EAR HOSE CLAMP	4.000	PC	TB2821A0	EPDM 6X10 L=40MM PIPE	6.000	PC	TB3004A0	TB2820A L=550mm EPDM BLACK PIPE	2.000	PC	TB3005B0	TB3132A L=550mm EPDM WHITE-BLUE PIPE	1.000	PC	TB3252A0	TB3252A0	1.000	PC	TB3469A0		1.000	PC	VH1220A1	4,2x12 TCB SELF-TAPPIN G SCREW	3.000	PC	VL1019A0	VIBRATION DETERGENT PUMP	1.000	PC	VL1047A1	D6 PIPE HOLDER - D8 J.G. TERMINAL	1.000	PC
Code	Description	Qty	UOM																																																																																		
0H2428A2	XECC PLUS WASHING CIRCUIT PLAT	1.000	PC																																																																																		
EL1450A0	US SELF-CLEANIN G WATER SOLENOID	3.000	PC																																																																																		
GN1311A0	RUBBER CABLE-PASSI NG Dø=25 Di=12 Th=6,5	1.000	PC																																																																																		
GN1526A0	INT. D.=6.9 TH=1.8 O-RIN	7.000	PC																																																																																		
RC1018A0	ZINC PLATED D12 ELASTIC CLAMP	5.000	PC																																																																																		
RC1019A0	D=10 ELASTIC CLAMP	14.000	PC																																																																																		
RC1130A0	130x2,6 CLAM	1.000	PC																																																																																		
RC1131A0	200x2,6 BLACK CLAMP	1.000	PC																																																																																		
RC1242A0	D=10 CLOSED CAP	2.000	PC																																																																																		
RC1356A0	*STRAIGHT THREADED FEMALE END 8x1/4" BS	1.000	PC																																																																																		
RC1414A1	D11.5-12.5 SINGLE EAR HOSE CLAMP	4.000	PC																																																																																		
TB2821A0	EPDM 6X10 L=40MM PIPE	6.000	PC																																																																																		
TB3004A0	TB2820A L=550mm EPDM BLACK PIPE	2.000	PC																																																																																		
TB3005B0	TB3132A L=550mm EPDM WHITE-BLUE PIPE	1.000	PC																																																																																		
TB3252A0	TB3252A0	1.000	PC																																																																																		
TB3469A0		1.000	PC																																																																																		
VH1220A1	4,2x12 TCB SELF-TAPPIN G SCREW	3.000	PC																																																																																		
VL1019A0	VIBRATION DETERGENT PUMP	1.000	PC																																																																																		
VL1047A1	D6 PIPE HOLDER - D8 J.G. TERMINAL	1.000	PC																																																																																		



COMPONENT			SPARE PART																																														
Code	Description	Image	Code	Description	Kit components																																												
VL1166A	BB6-AR6 L FITTING		KVL1213A	US PLUS COMPACT WASHING SYSTEM KIT	<table border="1"> <thead> <tr> <th>Code</th> <th>Description</th> <th>Qty</th> <th>UOM</th> </tr> </thead> <tbody> <tr> <td>VL1054B0</td> <td>ONE WASHING SYS INLET DISTRIBUTOR</td> <td>1.000</td> <td>PC</td> </tr> <tr> <td>VL1065A1</td> <td>1/4 MALE N.O. PRESSURE SWITCH</td> <td>1.000</td> <td>PC</td> </tr> <tr> <td>VL1102A1</td> <td>DETERGENT LINE FILTER + BARBED VNR 6 MM</td> <td>1.000</td> <td>PC</td> </tr> <tr> <td>VL1127A1</td> <td>6mm BARBED T-SHAPED FITTING</td> <td>1.000</td> <td>PC</td> </tr> <tr> <td>VL1128A1</td> <td>D6 BARBED CHECK VALVE</td> <td>2.000</td> <td>PC</td> </tr> <tr> <td>VL1165A0</td> <td>BAM-BB6 STRAIGHT FITTING</td> <td>1.000</td> <td>PC</td> </tr> <tr> <td>VL1166A0</td> <td>BB6-AR6 L FITTING</td> <td>3.000</td> <td>PC</td> </tr> <tr> <td>VL1174C0</td> <td>D1.2 MM CALIBRATED NOZZLE</td> <td>1.000</td> <td>PC</td> </tr> <tr> <td>VL1185A0</td> <td>2 WAYS PLUS WASHING DISTRIBUTOR</td> <td>1.000</td> <td>PC</td> </tr> <tr> <td>VM2172A0</td> <td>LOCKING CLIP FOR PUMP WITH CIRCUIT</td> <td>3.000</td> <td>PC</td> </tr> </tbody> </table>	Code	Description	Qty	UOM	VL1054B0	ONE WASHING SYS INLET DISTRIBUTOR	1.000	PC	VL1065A1	1/4 MALE N.O. PRESSURE SWITCH	1.000	PC	VL1102A1	DETERGENT LINE FILTER + BARBED VNR 6 MM	1.000	PC	VL1127A1	6mm BARBED T-SHAPED FITTING	1.000	PC	VL1128A1	D6 BARBED CHECK VALVE	2.000	PC	VL1165A0	BAM-BB6 STRAIGHT FITTING	1.000	PC	VL1166A0	BB6-AR6 L FITTING	3.000	PC	VL1174C0	D1.2 MM CALIBRATED NOZZLE	1.000	PC	VL1185A0	2 WAYS PLUS WASHING DISTRIBUTOR	1.000	PC	VM2172A0	LOCKING CLIP FOR PUMP WITH CIRCUIT	3.000	PC
Code	Description	Qty	UOM																																														
VL1054B0	ONE WASHING SYS INLET DISTRIBUTOR	1.000	PC																																														
VL1065A1	1/4 MALE N.O. PRESSURE SWITCH	1.000	PC																																														
VL1102A1	DETERGENT LINE FILTER + BARBED VNR 6 MM	1.000	PC																																														
VL1127A1	6mm BARBED T-SHAPED FITTING	1.000	PC																																														
VL1128A1	D6 BARBED CHECK VALVE	2.000	PC																																														
VL1165A0	BAM-BB6 STRAIGHT FITTING	1.000	PC																																														
VL1166A0	BB6-AR6 L FITTING	3.000	PC																																														
VL1174C0	D1.2 MM CALIBRATED NOZZLE	1.000	PC																																														
VL1185A0	2 WAYS PLUS WASHING DISTRIBUTOR	1.000	PC																																														
VM2172A0	LOCKING CLIP FOR PUMP WITH CIRCUIT	3.000	PC																																														
			KVL1212A	EUR COMPACT PLUS CLEANING SYSTEM KIT	<table border="1"> <thead> <tr> <th>Code</th> <th>Description</th> <th>Qty</th> <th>UOM</th> </tr> </thead> <tbody> <tr> <td>0H2428A2</td> <td>XECC PLUS WASHING CIRCUIT PLAT</td> <td>1.000</td> <td>PC</td> </tr> <tr> <td>EL1440A0</td> <td>WATER SELF CLEANING VALVE</td> <td>3.000</td> <td>PC</td> </tr> <tr> <td>GN1311A0</td> <td>RUBBER CABLE-PASSI NG D_e=25 D_i=12 Th=6,5</td> <td>1.000</td> <td>PC</td> </tr> <tr> <td>GN1526A0</td> <td>INT. D.=6.9 TH=1.8 O-RING</td> <td>7.000</td> <td>PC</td> </tr> <tr> <td>RC1018A0</td> <td>ZINC PLATED D12 ELASTIC CLAMP</td> <td>5.000</td> <td>PC</td> </tr> <tr> <td>RC1019A0</td> <td>D=10 ELASTIC CLAMP</td> <td>14.000</td> <td>PC</td> </tr> <tr> <td>RC1130A0</td> <td>130x2,6 CLAM</td> <td>1.000</td> <td>PC</td> </tr> <tr> <td>RC1131A0</td> <td>200x2,6 BLACK CLAMP</td> <td>1.000</td> <td>PC</td> </tr> <tr> <td>RC1242A0</td> <td>D=10 CLOSED CAP</td> <td>2.000</td> <td>PC</td> </tr> </tbody> </table>	Code	Description	Qty	UOM	0H2428A2	XECC PLUS WASHING CIRCUIT PLAT	1.000	PC	EL1440A0	WATER SELF CLEANING VALVE	3.000	PC	GN1311A0	RUBBER CABLE-PASSI NG D _e =25 D _i =12 Th=6,5	1.000	PC	GN1526A0	INT. D.=6.9 TH=1.8 O-RING	7.000	PC	RC1018A0	ZINC PLATED D12 ELASTIC CLAMP	5.000	PC	RC1019A0	D=10 ELASTIC CLAMP	14.000	PC	RC1130A0	130x2,6 CLAM	1.000	PC	RC1131A0	200x2,6 BLACK CLAMP	1.000	PC	RC1242A0	D=10 CLOSED CAP	2.000	PC				
Code	Description	Qty	UOM																																														
0H2428A2	XECC PLUS WASHING CIRCUIT PLAT	1.000	PC																																														
EL1440A0	WATER SELF CLEANING VALVE	3.000	PC																																														
GN1311A0	RUBBER CABLE-PASSI NG D _e =25 D _i =12 Th=6,5	1.000	PC																																														
GN1526A0	INT. D.=6.9 TH=1.8 O-RING	7.000	PC																																														
RC1018A0	ZINC PLATED D12 ELASTIC CLAMP	5.000	PC																																														
RC1019A0	D=10 ELASTIC CLAMP	14.000	PC																																														
RC1130A0	130x2,6 CLAM	1.000	PC																																														
RC1131A0	200x2,6 BLACK CLAMP	1.000	PC																																														
RC1242A0	D=10 CLOSED CAP	2.000	PC																																														

COMPONENT			SPARE PART																																																																														
Code	Description	Image	Code	Description	Kit components																																																																												
VL1166A	BB6-AR6 L FITTING		KVL1212A	EUR COMPACT PLUS CLEANING SYSTEM KIT	<table border="1"> <thead> <tr> <th>Code</th> <th>Description</th> <th>Qty</th> <th>UOM</th> </tr> </thead> <tbody> <tr> <td>RC1356A0</td> <td>"STRAIGHT THREADED FEMALE END 8x1/4" BS</td> <td>1.000</td> <td>PC</td> </tr> <tr> <td>RC1414A1</td> <td>D11.5-12.5 SINGLE EAR HOSE CLAMP</td> <td>4.000</td> <td>PC</td> </tr> <tr> <td>TB2821A0</td> <td>EPDM 6X10 L=40MM PIPE</td> <td>6.000</td> <td>PC</td> </tr> <tr> <td>TB3004A0</td> <td>TB2820A L=550mm EPDM BLACK PIPE</td> <td>2.000</td> <td>PC</td> </tr> <tr> <td>TB3005B0</td> <td>TB3132A L=550mm EPDM WHITE-BLUE PIPE</td> <td>1.000</td> <td>PC</td> </tr> <tr> <td>TB3252A0</td> <td>TB3252A0</td> <td>1.000</td> <td>PC</td> </tr> <tr> <td>TB3469A0</td> <td></td> <td>1.000</td> <td>PC</td> </tr> <tr> <td>VI1220A1</td> <td>4,2x12 TCB SELF-TAPPING SCREW</td> <td>3.000</td> <td>PC</td> </tr> <tr> <td>VL1019A0</td> <td>VIBRATION DETERGENT PUMP</td> <td>1.000</td> <td>PC</td> </tr> <tr> <td>VL1047A1</td> <td>D6 PIPE HOLDER - D8 J.G. TERMINAL</td> <td>1.000</td> <td>PC</td> </tr> <tr> <td>VL1054B0</td> <td>ONE WASHING SYS INLET DISTRIBUTOR</td> <td>1.000</td> <td>PC</td> </tr> <tr> <td>VL1065A1</td> <td>1/4 MALE N.O. PRESSURE SWITCH</td> <td>1.000</td> <td>PC</td> </tr> <tr> <td>VL1102A1</td> <td>DETERGENT LINE FILTER + BARBED VNR 6 MM</td> <td>1.000</td> <td>PC</td> </tr> <tr> <td>VL1127A1</td> <td>6mm BARBED T-SHAPED FITTING</td> <td>1.000</td> <td>PC</td> </tr> <tr> <td>VL1128A1</td> <td>D6 BARBED CHECK VALVE</td> <td>2.000</td> <td>PC</td> </tr> <tr> <td>VL1165A0</td> <td>BAM-BB6 STRAIGHT FITTING</td> <td>1.000</td> <td>PC</td> </tr> <tr> <td>VL1166A0</td> <td>BB6-AR6 L FITTING</td> <td>3.000</td> <td>PC</td> </tr> <tr> <td>VL1174C0</td> <td>D1.2 MM CALIBRATED NOZZLE</td> <td>1.000</td> <td>PC</td> </tr> </tbody> </table>	Code	Description	Qty	UOM	RC1356A0	"STRAIGHT THREADED FEMALE END 8x1/4" BS	1.000	PC	RC1414A1	D11.5-12.5 SINGLE EAR HOSE CLAMP	4.000	PC	TB2821A0	EPDM 6X10 L=40MM PIPE	6.000	PC	TB3004A0	TB2820A L=550mm EPDM BLACK PIPE	2.000	PC	TB3005B0	TB3132A L=550mm EPDM WHITE-BLUE PIPE	1.000	PC	TB3252A0	TB3252A0	1.000	PC	TB3469A0		1.000	PC	VI1220A1	4,2x12 TCB SELF-TAPPING SCREW	3.000	PC	VL1019A0	VIBRATION DETERGENT PUMP	1.000	PC	VL1047A1	D6 PIPE HOLDER - D8 J.G. TERMINAL	1.000	PC	VL1054B0	ONE WASHING SYS INLET DISTRIBUTOR	1.000	PC	VL1065A1	1/4 MALE N.O. PRESSURE SWITCH	1.000	PC	VL1102A1	DETERGENT LINE FILTER + BARBED VNR 6 MM	1.000	PC	VL1127A1	6mm BARBED T-SHAPED FITTING	1.000	PC	VL1128A1	D6 BARBED CHECK VALVE	2.000	PC	VL1165A0	BAM-BB6 STRAIGHT FITTING	1.000	PC	VL1166A0	BB6-AR6 L FITTING	3.000	PC	VL1174C0	D1.2 MM CALIBRATED NOZZLE	1.000	PC
Code	Description	Qty	UOM																																																																														
RC1356A0	"STRAIGHT THREADED FEMALE END 8x1/4" BS	1.000	PC																																																																														
RC1414A1	D11.5-12.5 SINGLE EAR HOSE CLAMP	4.000	PC																																																																														
TB2821A0	EPDM 6X10 L=40MM PIPE	6.000	PC																																																																														
TB3004A0	TB2820A L=550mm EPDM BLACK PIPE	2.000	PC																																																																														
TB3005B0	TB3132A L=550mm EPDM WHITE-BLUE PIPE	1.000	PC																																																																														
TB3252A0	TB3252A0	1.000	PC																																																																														
TB3469A0		1.000	PC																																																																														
VI1220A1	4,2x12 TCB SELF-TAPPING SCREW	3.000	PC																																																																														
VL1019A0	VIBRATION DETERGENT PUMP	1.000	PC																																																																														
VL1047A1	D6 PIPE HOLDER - D8 J.G. TERMINAL	1.000	PC																																																																														
VL1054B0	ONE WASHING SYS INLET DISTRIBUTOR	1.000	PC																																																																														
VL1065A1	1/4 MALE N.O. PRESSURE SWITCH	1.000	PC																																																																														
VL1102A1	DETERGENT LINE FILTER + BARBED VNR 6 MM	1.000	PC																																																																														
VL1127A1	6mm BARBED T-SHAPED FITTING	1.000	PC																																																																														
VL1128A1	D6 BARBED CHECK VALVE	2.000	PC																																																																														
VL1165A0	BAM-BB6 STRAIGHT FITTING	1.000	PC																																																																														
VL1166A0	BB6-AR6 L FITTING	3.000	PC																																																																														
VL1174C0	D1.2 MM CALIBRATED NOZZLE	1.000	PC																																																																														

COMPONENT			SPARE PART																																																																							
Code	Description	Image	Code	Description	Kit components																																																																					
VL1166A	BB6-AR6 L FITTING		KVL1212A	EUR COMPACT PLUS CLEANING SYSTEM KIT	<table border="1"> <thead> <tr> <th>Code</th> <th>Description</th> <th>Qty</th> <th>UOM</th> </tr> </thead> <tbody> <tr> <td>VL1185A0</td> <td>2 WAYS PLUS WASHING DISTRIBUTOR</td> <td>1.000</td> <td>PC</td> </tr> <tr> <td>VM2172A0</td> <td>LOCKING CLIP FOR PUMP WITH CIRCUIT</td> <td>3.000</td> <td>PC</td> </tr> </tbody> </table>	Code	Description	Qty	UOM	VL1185A0	2 WAYS PLUS WASHING DISTRIBUTOR	1.000	PC	VM2172A0	LOCKING CLIP FOR PUMP WITH CIRCUIT	3.000	PC																																																									
			Code	Description	Qty	UOM																																																																				
VL1185A0	2 WAYS PLUS WASHING DISTRIBUTOR	1.000	PC																																																																							
VM2172A0	LOCKING CLIP FOR PUMP WITH CIRCUIT	3.000	PC																																																																							
KVL1211A	ONE COMPACT AND 0523-EP WASH. SYSTEM KIT	<table border="1"> <thead> <tr> <th>Code</th> <th>Description</th> <th>Qty</th> <th>UOM</th> </tr> </thead> <tbody> <tr> <td>0H2427A0</td> <td>XECC WASHING CIRCUIT HOLDING PLATE</td> <td>1.000</td> <td>PC</td> </tr> <tr> <td>EL1440A0</td> <td>WATER SELF CLEANING VALVE</td> <td>1.000</td> <td>PC</td> </tr> <tr> <td>GN1526A0</td> <td>INT. D.=6.9 TH=1.8 O-RIN</td> <td>3.000</td> <td>PC</td> </tr> <tr> <td>RC1018A0</td> <td>ZINC PLATED D12 ELASTIC CLAMP</td> <td>4.000</td> <td>PC</td> </tr> <tr> <td>RC1019A0</td> <td>D=10 ELASTIC CLAMP</td> <td>14.000</td> <td>PC</td> </tr> <tr> <td>RC1130A0</td> <td>130x2.6 CLAM</td> <td>1.000</td> <td>PC</td> </tr> <tr> <td>RC1242A0</td> <td>D=10 CLOSED CAP</td> <td>2.000</td> <td>PC</td> </tr> <tr> <td>RC1414A1</td> <td>D11.5-12.5 SINGLE EAR HOSE CLAMP</td> <td>4.000</td> <td>PC</td> </tr> <tr> <td>TB2821A0</td> <td>EPDM 6X10 L=40MM PIPE</td> <td>6.000</td> <td>PC</td> </tr> <tr> <td>TB3004A0</td> <td>TB2820A L=550mm EPDM BLACK PIPE</td> <td>1.000</td> <td>PC</td> </tr> <tr> <td>TB3252A0</td> <td>TB3252A0</td> <td>1.000</td> <td>PC</td> </tr> <tr> <td>TB3469A0</td> <td></td> <td>1.000</td> <td>PC</td> </tr> <tr> <td>VI1220A1</td> <td>4,2x12 TCB SELF-TAPPIN G SCREW</td> <td>4.000</td> <td>PC</td> </tr> <tr> <td>VL1019A0</td> <td>VIBRATION DETERGENT PUMP</td> <td>1.000</td> <td>PC</td> </tr> <tr> <td>VL1047A1</td> <td>D6 PIPE HOLDER - D8 J.G. TERMINAL</td> <td>1.000</td> <td>PC</td> </tr> <tr> <td>VL1054B0</td> <td>ONE WASHING SYS INLET DISTRIBUTOR</td> <td>1.000</td> <td>PC</td> </tr> <tr> <td>VL1102A1</td> <td>DETERGENT LINE FILTER + BARBED VNR 6 MM</td> <td>1.000</td> <td>PC</td> </tr> </tbody> </table>	Code	Description	Qty	UOM	0H2427A0	XECC WASHING CIRCUIT HOLDING PLATE	1.000	PC	EL1440A0	WATER SELF CLEANING VALVE	1.000	PC	GN1526A0	INT. D.=6.9 TH=1.8 O-RIN	3.000	PC	RC1018A0	ZINC PLATED D12 ELASTIC CLAMP	4.000	PC	RC1019A0	D=10 ELASTIC CLAMP	14.000	PC	RC1130A0	130x2.6 CLAM	1.000	PC	RC1242A0	D=10 CLOSED CAP	2.000	PC	RC1414A1	D11.5-12.5 SINGLE EAR HOSE CLAMP	4.000	PC	TB2821A0	EPDM 6X10 L=40MM PIPE	6.000	PC	TB3004A0	TB2820A L=550mm EPDM BLACK PIPE	1.000	PC	TB3252A0	TB3252A0	1.000	PC	TB3469A0		1.000	PC	VI1220A1	4,2x12 TCB SELF-TAPPIN G SCREW	4.000	PC	VL1019A0	VIBRATION DETERGENT PUMP	1.000	PC	VL1047A1	D6 PIPE HOLDER - D8 J.G. TERMINAL	1.000	PC	VL1054B0	ONE WASHING SYS INLET DISTRIBUTOR	1.000	PC	VL1102A1	DETERGENT LINE FILTER + BARBED VNR 6 MM	1.000	PC
Code	Description	Qty	UOM																																																																							
0H2427A0	XECC WASHING CIRCUIT HOLDING PLATE	1.000	PC																																																																							
EL1440A0	WATER SELF CLEANING VALVE	1.000	PC																																																																							
GN1526A0	INT. D.=6.9 TH=1.8 O-RIN	3.000	PC																																																																							
RC1018A0	ZINC PLATED D12 ELASTIC CLAMP	4.000	PC																																																																							
RC1019A0	D=10 ELASTIC CLAMP	14.000	PC																																																																							
RC1130A0	130x2.6 CLAM	1.000	PC																																																																							
RC1242A0	D=10 CLOSED CAP	2.000	PC																																																																							
RC1414A1	D11.5-12.5 SINGLE EAR HOSE CLAMP	4.000	PC																																																																							
TB2821A0	EPDM 6X10 L=40MM PIPE	6.000	PC																																																																							
TB3004A0	TB2820A L=550mm EPDM BLACK PIPE	1.000	PC																																																																							
TB3252A0	TB3252A0	1.000	PC																																																																							
TB3469A0		1.000	PC																																																																							
VI1220A1	4,2x12 TCB SELF-TAPPIN G SCREW	4.000	PC																																																																							
VL1019A0	VIBRATION DETERGENT PUMP	1.000	PC																																																																							
VL1047A1	D6 PIPE HOLDER - D8 J.G. TERMINAL	1.000	PC																																																																							
VL1054B0	ONE WASHING SYS INLET DISTRIBUTOR	1.000	PC																																																																							
VL1102A1	DETERGENT LINE FILTER + BARBED VNR 6 MM	1.000	PC																																																																							



COMPONENT			SPARE PART																																																										
Code	Description	Image	Code	Description	Kit components																																																								
VL1166A	BB6-AR6 L FITTING		KVL1211A	ONE COMPACT AND 0523-EP WASH. SYSTEM KIT	<table border="1"> <thead> <tr> <th>Code</th> <th>Description</th> <th>Qty</th> <th>UOM</th> </tr> </thead> <tbody> <tr> <td>VL1127A1</td> <td>6mm BARBED T-SHAPED FITTING</td> <td>1.000</td> <td>PC</td> </tr> <tr> <td>VL1128A1</td> <td>D6 BARBED CHECK VALVE</td> <td>2.000</td> <td>PC</td> </tr> <tr> <td>VL1165A0</td> <td>BAM-BB6 STRAIGHT FITTING</td> <td>1.000</td> <td>PC</td> </tr> <tr> <td>VL1166A0</td> <td>BB6-AR6 L FITTING</td> <td>1.000</td> <td>PC</td> </tr> <tr> <td>VL1174C0</td> <td>D1.2 MM CALIBRATED NOZZLE</td> <td>1.000</td> <td>PC</td> </tr> <tr> <td>VL1191A0</td> <td>ONE WASHING DISTRIBUTOR OUTLETS KIT</td> <td>1.000</td> <td>PC</td> </tr> <tr> <td>VM2172A0</td> <td>LOCKING CLIP FOR PUMP WITH CIRCUIT</td> <td>2.000</td> <td>PC</td> </tr> </tbody> </table>	Code	Description	Qty	UOM	VL1127A1	6mm BARBED T-SHAPED FITTING	1.000	PC	VL1128A1	D6 BARBED CHECK VALVE	2.000	PC	VL1165A0	BAM-BB6 STRAIGHT FITTING	1.000	PC	VL1166A0	BB6-AR6 L FITTING	1.000	PC	VL1174C0	D1.2 MM CALIBRATED NOZZLE	1.000	PC	VL1191A0	ONE WASHING DISTRIBUTOR OUTLETS KIT	1.000	PC	VM2172A0	LOCKING CLIP FOR PUMP WITH CIRCUIT	2.000	PC																								
Code	Description	Qty	UOM																																																										
VL1127A1	6mm BARBED T-SHAPED FITTING	1.000	PC																																																										
VL1128A1	D6 BARBED CHECK VALVE	2.000	PC																																																										
VL1165A0	BAM-BB6 STRAIGHT FITTING	1.000	PC																																																										
VL1166A0	BB6-AR6 L FITTING	1.000	PC																																																										
VL1174C0	D1.2 MM CALIBRATED NOZZLE	1.000	PC																																																										
VL1191A0	ONE WASHING DISTRIBUTOR OUTLETS KIT	1.000	PC																																																										
VM2172A0	LOCKING CLIP FOR PUMP WITH CIRCUIT	2.000	PC																																																										
			KVL1209A	US PLUS 3 ROTOR ARMS WASHING SYSTEM KIT	<table border="1"> <thead> <tr> <th>Code</th> <th>Description</th> <th>Qty</th> <th>UOM</th> </tr> </thead> <tbody> <tr> <td>0H2354A1</td> <td>XEVC-XEVL PLUS WASHING CIRCUIT PLAT</td> <td>1.000</td> <td>PC</td> </tr> <tr> <td>EL1450A0</td> <td>US SELF-CLEANING WATER SOLENOID</td> <td>4.000</td> <td>PC</td> </tr> <tr> <td>GN1526A0</td> <td>INT. D.=6.9 TH=1.8 O-RING</td> <td>9.000</td> <td>PC</td> </tr> <tr> <td>RC1018A0</td> <td>ZINC PLATED D12 ELASTIC CLAMP</td> <td>11.000</td> <td>PC</td> </tr> <tr> <td>RC1019A0</td> <td>D=10 ELASTIC CLAMP</td> <td>14.000</td> <td>PC</td> </tr> <tr> <td>RC1130A0</td> <td>130x2.6 CLAMP</td> <td>1.000</td> <td>PC</td> </tr> <tr> <td>RC1131A0</td> <td>200x2.6 BLACK CLAMP</td> <td>3.000</td> <td>PC</td> </tr> <tr> <td>RC1242A0</td> <td>D=10 CLOSED CAP</td> <td>2.000</td> <td>PC</td> </tr> <tr> <td>RC1356A0</td> <td>"STRAIGHT THREADED FEMALE END 8x1/4" BS</td> <td>1.000</td> <td>PC</td> </tr> <tr> <td>RC1414A1</td> <td>D11.5-12.5 SINGLE EAR HOSE CLAMP</td> <td>1.000</td> <td>PC</td> </tr> <tr> <td>TB2652A0</td> <td></td> <td>1.000</td> <td>PC</td> </tr> <tr> <td>TB2677A0</td> <td></td> <td>1.000</td> <td>PC</td> </tr> <tr> <td>TB2821A0</td> <td>EPDM 6X10 L=40MM PIPE</td> <td>4.000</td> <td>PC</td> </tr> </tbody> </table>	Code	Description	Qty	UOM	0H2354A1	XEVC-XEVL PLUS WASHING CIRCUIT PLAT	1.000	PC	EL1450A0	US SELF-CLEANING WATER SOLENOID	4.000	PC	GN1526A0	INT. D.=6.9 TH=1.8 O-RING	9.000	PC	RC1018A0	ZINC PLATED D12 ELASTIC CLAMP	11.000	PC	RC1019A0	D=10 ELASTIC CLAMP	14.000	PC	RC1130A0	130x2.6 CLAMP	1.000	PC	RC1131A0	200x2.6 BLACK CLAMP	3.000	PC	RC1242A0	D=10 CLOSED CAP	2.000	PC	RC1356A0	"STRAIGHT THREADED FEMALE END 8x1/4" BS	1.000	PC	RC1414A1	D11.5-12.5 SINGLE EAR HOSE CLAMP	1.000	PC	TB2652A0		1.000	PC	TB2677A0		1.000	PC	TB2821A0	EPDM 6X10 L=40MM PIPE	4.000	PC
Code	Description	Qty	UOM																																																										
0H2354A1	XEVC-XEVL PLUS WASHING CIRCUIT PLAT	1.000	PC																																																										
EL1450A0	US SELF-CLEANING WATER SOLENOID	4.000	PC																																																										
GN1526A0	INT. D.=6.9 TH=1.8 O-RING	9.000	PC																																																										
RC1018A0	ZINC PLATED D12 ELASTIC CLAMP	11.000	PC																																																										
RC1019A0	D=10 ELASTIC CLAMP	14.000	PC																																																										
RC1130A0	130x2.6 CLAMP	1.000	PC																																																										
RC1131A0	200x2.6 BLACK CLAMP	3.000	PC																																																										
RC1242A0	D=10 CLOSED CAP	2.000	PC																																																										
RC1356A0	"STRAIGHT THREADED FEMALE END 8x1/4" BS	1.000	PC																																																										
RC1414A1	D11.5-12.5 SINGLE EAR HOSE CLAMP	1.000	PC																																																										
TB2652A0		1.000	PC																																																										
TB2677A0		1.000	PC																																																										
TB2821A0	EPDM 6X10 L=40MM PIPE	4.000	PC																																																										



COMPONENT			SPARE PART																																																																																		
Code	Description	Image	Code	Description	Kit components																																																																																
VL1166A	BB6-AR6 L FITTING		KVL1209A	US PLUS 3 ROTOR ARMS WASHING SYSTEM KIT	<table border="1"> <thead> <tr> <th>Code</th> <th>Description</th> <th>Qty</th> <th>UOM</th> </tr> </thead> <tbody> <tr> <td>TB3004A0</td> <td>TB2820A L=550mm EPDM BLACK PIPE</td> <td>2.000</td> <td>PC</td> </tr> <tr> <td>TB3024C0</td> <td></td> <td>3.000</td> <td>PC</td> </tr> <tr> <td>TB3226A0</td> <td></td> <td>1.000</td> <td>PC</td> </tr> <tr> <td>TB3440A0</td> <td>TB3132A L=1050mm EPDM WHITE-BLUE PIPE</td> <td>1.000</td> <td>PC</td> </tr> <tr> <td>TB3614A0</td> <td>TB3614A0</td> <td>1.000</td> <td>PC</td> </tr> <tr> <td>VI1220A1</td> <td>4,2x12 TCB SELF-TAPPIN G SCREW</td> <td>1.000</td> <td>PC</td> </tr> <tr> <td>VL1019A0</td> <td>VIBRATION DETERGENT PUMP</td> <td>1.000</td> <td>PC</td> </tr> <tr> <td>VL1065A1</td> <td>1/4 MALE N.O. PRESSURE SWITCH</td> <td>1.000</td> <td>PC</td> </tr> <tr> <td>VL1102A1</td> <td>DETERGENT LINE FILTER + BARBED VNR 6 MM</td> <td>1.000</td> <td>PC</td> </tr> <tr> <td>VL1127A1</td> <td>6mm BARBED T-SHAPED FITTING</td> <td>2.000</td> <td>PC</td> </tr> <tr> <td>VL1128A1</td> <td>D6 BARBED CHECK VALVE</td> <td>2.000</td> <td>PC</td> </tr> <tr> <td>VL1166A0</td> <td>BB6-AR6 L FITTING</td> <td>4.000</td> <td>PC</td> </tr> <tr> <td>VL1167A2</td> <td>GN21 3 ROTOR ARMS B-B FLOW RESTRICTOR</td> <td>1.000</td> <td>PC</td> </tr> <tr> <td>VL1174C0</td> <td>D1.2 MM CALIBRATED NOZZLE</td> <td>1.000</td> <td>PC</td> </tr> <tr> <td>VL1186A0</td> <td>3 WAYS PLUS WASHING DISTRIBUTOR</td> <td>1.000</td> <td>PC</td> </tr> <tr> <td>VL1190A0</td> <td>PLUS WASHING SYSTEM INLET DISTRIBUTOR</td> <td>1.000</td> <td>PC</td> </tr> <tr> <td>VL1214A0</td> <td>BAYONET - 6mm BARBED NRV VALVE</td> <td>1.000</td> <td>PC</td> </tr> <tr> <td>VM1605A0</td> <td>CLIP TWIST LOCK DIAM. 10,2-12,7 MM</td> <td>3.000</td> <td>PC</td> </tr> <tr> <td>VM2172A0</td> <td>LOCKING CLIP FOR PUMP WITH CIRCUIT</td> <td>5.000</td> <td>PC</td> </tr> </tbody> </table>	Code	Description	Qty	UOM	TB3004A0	TB2820A L=550mm EPDM BLACK PIPE	2.000	PC	TB3024C0		3.000	PC	TB3226A0		1.000	PC	TB3440A0	TB3132A L=1050mm EPDM WHITE-BLUE PIPE	1.000	PC	TB3614A0	TB3614A0	1.000	PC	VI1220A1	4,2x12 TCB SELF-TAPPIN G SCREW	1.000	PC	VL1019A0	VIBRATION DETERGENT PUMP	1.000	PC	VL1065A1	1/4 MALE N.O. PRESSURE SWITCH	1.000	PC	VL1102A1	DETERGENT LINE FILTER + BARBED VNR 6 MM	1.000	PC	VL1127A1	6mm BARBED T-SHAPED FITTING	2.000	PC	VL1128A1	D6 BARBED CHECK VALVE	2.000	PC	VL1166A0	BB6-AR6 L FITTING	4.000	PC	VL1167A2	GN21 3 ROTOR ARMS B-B FLOW RESTRICTOR	1.000	PC	VL1174C0	D1.2 MM CALIBRATED NOZZLE	1.000	PC	VL1186A0	3 WAYS PLUS WASHING DISTRIBUTOR	1.000	PC	VL1190A0	PLUS WASHING SYSTEM INLET DISTRIBUTOR	1.000	PC	VL1214A0	BAYONET - 6mm BARBED NRV VALVE	1.000	PC	VM1605A0	CLIP TWIST LOCK DIAM. 10,2-12,7 MM	3.000	PC	VM2172A0	LOCKING CLIP FOR PUMP WITH CIRCUIT	5.000	PC
Code	Description	Qty	UOM																																																																																		
TB3004A0	TB2820A L=550mm EPDM BLACK PIPE	2.000	PC																																																																																		
TB3024C0		3.000	PC																																																																																		
TB3226A0		1.000	PC																																																																																		
TB3440A0	TB3132A L=1050mm EPDM WHITE-BLUE PIPE	1.000	PC																																																																																		
TB3614A0	TB3614A0	1.000	PC																																																																																		
VI1220A1	4,2x12 TCB SELF-TAPPIN G SCREW	1.000	PC																																																																																		
VL1019A0	VIBRATION DETERGENT PUMP	1.000	PC																																																																																		
VL1065A1	1/4 MALE N.O. PRESSURE SWITCH	1.000	PC																																																																																		
VL1102A1	DETERGENT LINE FILTER + BARBED VNR 6 MM	1.000	PC																																																																																		
VL1127A1	6mm BARBED T-SHAPED FITTING	2.000	PC																																																																																		
VL1128A1	D6 BARBED CHECK VALVE	2.000	PC																																																																																		
VL1166A0	BB6-AR6 L FITTING	4.000	PC																																																																																		
VL1167A2	GN21 3 ROTOR ARMS B-B FLOW RESTRICTOR	1.000	PC																																																																																		
VL1174C0	D1.2 MM CALIBRATED NOZZLE	1.000	PC																																																																																		
VL1186A0	3 WAYS PLUS WASHING DISTRIBUTOR	1.000	PC																																																																																		
VL1190A0	PLUS WASHING SYSTEM INLET DISTRIBUTOR	1.000	PC																																																																																		
VL1214A0	BAYONET - 6mm BARBED NRV VALVE	1.000	PC																																																																																		
VM1605A0	CLIP TWIST LOCK DIAM. 10,2-12,7 MM	3.000	PC																																																																																		
VM2172A0	LOCKING CLIP FOR PUMP WITH CIRCUIT	5.000	PC																																																																																		



COMPONENT			SPARE PART																																																																														
Code	Description	Image	Code	Description	Kit components																																																																												
VL1166A	BB6-AR6 L FITTING		KVL1208A	US PLUS 2 ROTOR ARMS WASHING SYSTEM KIT	<table border="1"> <thead> <tr> <th>Code</th> <th>Description</th> <th>Qty</th> <th>UOM</th> </tr> </thead> <tbody> <tr> <td>0H2354A1</td> <td>XEVC-XEVL PLUS WASHING CIRCUIT PLAT</td> <td>1.000</td> <td>PC</td> </tr> <tr> <td>EL1450A0</td> <td>US SELF-CLEANIN G WATER SOLENOID</td> <td>4.000</td> <td>PC</td> </tr> <tr> <td>GN1526A0</td> <td>INT. D.=6.9 TH=1.8 O-RIN</td> <td>9.000</td> <td>PC</td> </tr> <tr> <td>RC1018A0</td> <td>ZINC PLATED D12 ELASTIC CLAMP</td> <td>3.000</td> <td>PC</td> </tr> <tr> <td>RC1019A0</td> <td>D=10 ELASTIC CLAMP</td> <td>2.000</td> <td>PC</td> </tr> <tr> <td>RC1130A0</td> <td>130x2.6 CLAM</td> <td>1.000</td> <td>PC</td> </tr> <tr> <td>RC1131A0</td> <td>200x2.6 BLACK CLAMP</td> <td>3.000</td> <td>PC</td> </tr> <tr> <td>RC1242A0</td> <td>D=10 CLOSED CAP</td> <td>2.000</td> <td>PC</td> </tr> <tr> <td>RC1356A0</td> <td>*STRAIGHT THREADED FEMALE END 8x1/4" BS</td> <td>1.000</td> <td>PC</td> </tr> <tr> <td>RC1414A1</td> <td>D11.5-12.5 SINGLE EAR HOSE CLAMP</td> <td>4.000</td> <td>PC</td> </tr> <tr> <td>TB2821A0</td> <td>EPDM 6X10 L=40MM PIPE</td> <td>6.000</td> <td>PC</td> </tr> <tr> <td>TB2994A0</td> <td>HOOD DETERGENT PIPE</td> <td>1.000</td> <td>PC</td> </tr> <tr> <td>TB3004A0</td> <td>TB2820A L=550mm EPDM BLACK PIPE</td> <td>1.000</td> <td>PC</td> </tr> <tr> <td>TB3005B0</td> <td>TB3132A L=550mm EPDM WHITE-BLUE PIPE</td> <td>1.000</td> <td>PC</td> </tr> <tr> <td>TB3440A0</td> <td>TB3132A L=1050mm EPDM WHITE-BLUE PIPE</td> <td>1.000</td> <td>PC</td> </tr> <tr> <td>VL1019A0</td> <td>VIBRATION DETERGENT PUMP</td> <td>1.000</td> <td>PC</td> </tr> <tr> <td>VL1047A1</td> <td>D6 PIPE HOLDER - D8 J.G. TERMINAL</td> <td>1.000</td> <td>PC</td> </tr> <tr> <td>VL1065A1</td> <td>1/4 MALE N.O. PRESSURE SWITCH</td> <td>1.000</td> <td>PC</td> </tr> </tbody> </table>	Code	Description	Qty	UOM	0H2354A1	XEVC-XEVL PLUS WASHING CIRCUIT PLAT	1.000	PC	EL1450A0	US SELF-CLEANIN G WATER SOLENOID	4.000	PC	GN1526A0	INT. D.=6.9 TH=1.8 O-RIN	9.000	PC	RC1018A0	ZINC PLATED D12 ELASTIC CLAMP	3.000	PC	RC1019A0	D=10 ELASTIC CLAMP	2.000	PC	RC1130A0	130x2.6 CLAM	1.000	PC	RC1131A0	200x2.6 BLACK CLAMP	3.000	PC	RC1242A0	D=10 CLOSED CAP	2.000	PC	RC1356A0	*STRAIGHT THREADED FEMALE END 8x1/4" BS	1.000	PC	RC1414A1	D11.5-12.5 SINGLE EAR HOSE CLAMP	4.000	PC	TB2821A0	EPDM 6X10 L=40MM PIPE	6.000	PC	TB2994A0	HOOD DETERGENT PIPE	1.000	PC	TB3004A0	TB2820A L=550mm EPDM BLACK PIPE	1.000	PC	TB3005B0	TB3132A L=550mm EPDM WHITE-BLUE PIPE	1.000	PC	TB3440A0	TB3132A L=1050mm EPDM WHITE-BLUE PIPE	1.000	PC	VL1019A0	VIBRATION DETERGENT PUMP	1.000	PC	VL1047A1	D6 PIPE HOLDER - D8 J.G. TERMINAL	1.000	PC	VL1065A1	1/4 MALE N.O. PRESSURE SWITCH	1.000	PC
Code	Description	Qty	UOM																																																																														
0H2354A1	XEVC-XEVL PLUS WASHING CIRCUIT PLAT	1.000	PC																																																																														
EL1450A0	US SELF-CLEANIN G WATER SOLENOID	4.000	PC																																																																														
GN1526A0	INT. D.=6.9 TH=1.8 O-RIN	9.000	PC																																																																														
RC1018A0	ZINC PLATED D12 ELASTIC CLAMP	3.000	PC																																																																														
RC1019A0	D=10 ELASTIC CLAMP	2.000	PC																																																																														
RC1130A0	130x2.6 CLAM	1.000	PC																																																																														
RC1131A0	200x2.6 BLACK CLAMP	3.000	PC																																																																														
RC1242A0	D=10 CLOSED CAP	2.000	PC																																																																														
RC1356A0	*STRAIGHT THREADED FEMALE END 8x1/4" BS	1.000	PC																																																																														
RC1414A1	D11.5-12.5 SINGLE EAR HOSE CLAMP	4.000	PC																																																																														
TB2821A0	EPDM 6X10 L=40MM PIPE	6.000	PC																																																																														
TB2994A0	HOOD DETERGENT PIPE	1.000	PC																																																																														
TB3004A0	TB2820A L=550mm EPDM BLACK PIPE	1.000	PC																																																																														
TB3005B0	TB3132A L=550mm EPDM WHITE-BLUE PIPE	1.000	PC																																																																														
TB3440A0	TB3132A L=1050mm EPDM WHITE-BLUE PIPE	1.000	PC																																																																														
VL1019A0	VIBRATION DETERGENT PUMP	1.000	PC																																																																														
VL1047A1	D6 PIPE HOLDER - D8 J.G. TERMINAL	1.000	PC																																																																														
VL1065A1	1/4 MALE N.O. PRESSURE SWITCH	1.000	PC																																																																														





COMPONENT			SPARE PART																																														
Code	Description	Image	Code	Description	Kit components																																												
VL1166A	BB6-AR6 L FITTING		KVL1208A	US PLUS 2 ROTOR ARMS WASHING SYSTEM KIT	<table border="1"> <thead> <tr> <th>Code</th> <th>Description</th> <th>Qty</th> <th>UOM</th> </tr> </thead> <tbody> <tr> <td>VL1102A1</td> <td>DETERGENT LINE FILTER + BARBED VNR 6 MM</td> <td>1.000</td> <td>PC</td> </tr> <tr> <td>VL1128A1</td> <td>D6 BARBED CHECK VALVE</td> <td>2.000</td> <td>PC</td> </tr> <tr> <td>VL1141A1</td> <td>BB6-BB6 STRAIGHT CONNECTION</td> <td>1.000</td> <td>PC</td> </tr> <tr> <td>VL1166A0</td> <td>BB6-AR6 L FITTING</td> <td>4.000</td> <td>PC</td> </tr> <tr> <td>VL1174C0</td> <td>D1.2 MM CALIBRATED NOZZLE</td> <td>1.000</td> <td>PC</td> </tr> <tr> <td>VL1186A0</td> <td>3 WAYS PLUS WASHING DISTRIBUTOR</td> <td>1.000</td> <td>PC</td> </tr> <tr> <td>VL1190A0</td> <td>PLUS WASHING SYSTEM INLET DISTRIBUTOR</td> <td>1.000</td> <td>PC</td> </tr> <tr> <td>VL1214A0</td> <td>BAYONET - 6mm BARBED NRV VALVE</td> <td>1.000</td> <td>PC</td> </tr> <tr> <td>VM1605A0</td> <td>CLIP TWIST LOCK DIAM. 10.2-12.7 MM</td> <td>3.000</td> <td>PC</td> </tr> <tr> <td>VM2172A0</td> <td>LOCKING CLIP FOR PUMP WITH CIRCUIT</td> <td>5.000</td> <td>PC</td> </tr> </tbody> </table>	Code	Description	Qty	UOM	VL1102A1	DETERGENT LINE FILTER + BARBED VNR 6 MM	1.000	PC	VL1128A1	D6 BARBED CHECK VALVE	2.000	PC	VL1141A1	BB6-BB6 STRAIGHT CONNECTION	1.000	PC	VL1166A0	BB6-AR6 L FITTING	4.000	PC	VL1174C0	D1.2 MM CALIBRATED NOZZLE	1.000	PC	VL1186A0	3 WAYS PLUS WASHING DISTRIBUTOR	1.000	PC	VL1190A0	PLUS WASHING SYSTEM INLET DISTRIBUTOR	1.000	PC	VL1214A0	BAYONET - 6mm BARBED NRV VALVE	1.000	PC	VM1605A0	CLIP TWIST LOCK DIAM. 10.2-12.7 MM	3.000	PC	VM2172A0	LOCKING CLIP FOR PUMP WITH CIRCUIT	5.000	PC
Code	Description	Qty	UOM																																														
VL1102A1	DETERGENT LINE FILTER + BARBED VNR 6 MM	1.000	PC																																														
VL1128A1	D6 BARBED CHECK VALVE	2.000	PC																																														
VL1141A1	BB6-BB6 STRAIGHT CONNECTION	1.000	PC																																														
VL1166A0	BB6-AR6 L FITTING	4.000	PC																																														
VL1174C0	D1.2 MM CALIBRATED NOZZLE	1.000	PC																																														
VL1186A0	3 WAYS PLUS WASHING DISTRIBUTOR	1.000	PC																																														
VL1190A0	PLUS WASHING SYSTEM INLET DISTRIBUTOR	1.000	PC																																														
VL1214A0	BAYONET - 6mm BARBED NRV VALVE	1.000	PC																																														
VM1605A0	CLIP TWIST LOCK DIAM. 10.2-12.7 MM	3.000	PC																																														
VM2172A0	LOCKING CLIP FOR PUMP WITH CIRCUIT	5.000	PC																																														
			KVL1207A	US PLUS 1 ROTOR ARM WASHING SYSTEM KIT	<table border="1"> <thead> <tr> <th>Code</th> <th>Description</th> <th>Qty</th> <th>UOM</th> </tr> </thead> <tbody> <tr> <td>0H2354A1</td> <td>XEVC-XEVL PLUS WASHING CIRCUIT PLAT</td> <td>1.000</td> <td>PC</td> </tr> <tr> <td>EL1450A0</td> <td>US SELF-CLEANING WATER SOLENOID</td> <td>3.000</td> <td>PC</td> </tr> <tr> <td>GN1526A0</td> <td>INT. D.=6.9 TH=1.8 O-RIN</td> <td>7.000</td> <td>PC</td> </tr> <tr> <td>RC1018A0</td> <td>ZINC PLATED D12 ELASTIC CLAMP</td> <td>1.000</td> <td>PC</td> </tr> <tr> <td>RC1019A0</td> <td>D=10 ELASTIC CLAMP</td> <td>12.000</td> <td>PC</td> </tr> <tr> <td>RC1130A0</td> <td>130x2.6 CLAM</td> <td>1.000</td> <td>PC</td> </tr> <tr> <td>RC1131A0</td> <td>200x2.6 BLACK CLAMP</td> <td>2.000</td> <td>PC</td> </tr> <tr> <td>RC1242A0</td> <td>D=10 CLOSED CAP</td> <td>2.000</td> <td>PC</td> </tr> </tbody> </table>	Code	Description	Qty	UOM	0H2354A1	XEVC-XEVL PLUS WASHING CIRCUIT PLAT	1.000	PC	EL1450A0	US SELF-CLEANING WATER SOLENOID	3.000	PC	GN1526A0	INT. D.=6.9 TH=1.8 O-RIN	7.000	PC	RC1018A0	ZINC PLATED D12 ELASTIC CLAMP	1.000	PC	RC1019A0	D=10 ELASTIC CLAMP	12.000	PC	RC1130A0	130x2.6 CLAM	1.000	PC	RC1131A0	200x2.6 BLACK CLAMP	2.000	PC	RC1242A0	D=10 CLOSED CAP	2.000	PC								
Code	Description	Qty	UOM																																														
0H2354A1	XEVC-XEVL PLUS WASHING CIRCUIT PLAT	1.000	PC																																														
EL1450A0	US SELF-CLEANING WATER SOLENOID	3.000	PC																																														
GN1526A0	INT. D.=6.9 TH=1.8 O-RIN	7.000	PC																																														
RC1018A0	ZINC PLATED D12 ELASTIC CLAMP	1.000	PC																																														
RC1019A0	D=10 ELASTIC CLAMP	12.000	PC																																														
RC1130A0	130x2.6 CLAM	1.000	PC																																														
RC1131A0	200x2.6 BLACK CLAMP	2.000	PC																																														
RC1242A0	D=10 CLOSED CAP	2.000	PC																																														



COMPONENT			SPARE PART																																																																														
Code	Description	Image	Code	Description	Kit components																																																																												
VL1166A	BB6-AR6 L FITTING		KVL1207A	US PLUS 1 ROTOR ARM WASHING SYSTEM KIT	<table border="1"> <thead> <tr> <th>Code</th> <th>Description</th> <th>Qty</th> <th>UOM</th> </tr> </thead> <tbody> <tr> <td>RC1356A0</td> <td>"STRAIGHT THREADED FEMALE END 8x1/4" BS</td> <td>1.000</td> <td>PC</td> </tr> <tr> <td>RC1414A1</td> <td>D11.5-12.5 SINGLE EAR HOSE CLAMP</td> <td>5.000</td> <td>PC</td> </tr> <tr> <td>TB2821A0</td> <td>EPDM 6X10 L=40MM PIPE</td> <td>4.000</td> <td>PC</td> </tr> <tr> <td>TB3004A0</td> <td>TB2820A L=550mm EPDM BLACK PIPE</td> <td>1.000</td> <td>PC</td> </tr> <tr> <td>TB3005B0</td> <td>TB3132A L=550mm EPDM WHITE-BLUE PIPE</td> <td>2.000</td> <td>PC</td> </tr> <tr> <td>TB3024C0</td> <td></td> <td>1.000</td> <td>PC</td> </tr> <tr> <td>TB3225B0</td> <td>TB2820A-TAN K-WASHYNG SYS CONNECTION</td> <td>1.000</td> <td>PC</td> </tr> <tr> <td>TB3252A0</td> <td>TB3252A0</td> <td>1.000</td> <td>PC</td> </tr> <tr> <td>TB3614A0</td> <td>TB3614A0</td> <td>1.000</td> <td>PC</td> </tr> <tr> <td>VH1220A1</td> <td>4,2x12 TCB SELF-TAPPIN G SCREW</td> <td>1.000</td> <td>PC</td> </tr> <tr> <td>VL1019A0</td> <td>VIBRATION DETERGENT PUMP</td> <td>1.000</td> <td>PC</td> </tr> <tr> <td>VL1047A1</td> <td>D6 PIPE HOLDER - D8 J.G. TERMINAL</td> <td>1.000</td> <td>PC</td> </tr> <tr> <td>VL1102A1</td> <td>DETERGENT LINE FILTER + BARBED VNR 6 MM</td> <td>1.000</td> <td>PC</td> </tr> <tr> <td>VL1127A1</td> <td>6mm BARBED T-SHAPED FITTING</td> <td>1.000</td> <td>PC</td> </tr> <tr> <td>VL1128A1</td> <td>D6 BARBED CHECK VALVE</td> <td>1.000</td> <td>PC</td> </tr> <tr> <td>VL1166A0</td> <td>BB6-AR6 L FITTING</td> <td>3.000</td> <td>PC</td> </tr> <tr> <td>VL1174C0</td> <td>D1.2 MM CALIBRATED NOZZLE</td> <td>1.000</td> <td>PC</td> </tr> <tr> <td>VL1185A0</td> <td>2 WAYS PLUS WASHING DISTRIBUTOR</td> <td>1.000</td> <td>PC</td> </tr> </tbody> </table>	Code	Description	Qty	UOM	RC1356A0	"STRAIGHT THREADED FEMALE END 8x1/4" BS	1.000	PC	RC1414A1	D11.5-12.5 SINGLE EAR HOSE CLAMP	5.000	PC	TB2821A0	EPDM 6X10 L=40MM PIPE	4.000	PC	TB3004A0	TB2820A L=550mm EPDM BLACK PIPE	1.000	PC	TB3005B0	TB3132A L=550mm EPDM WHITE-BLUE PIPE	2.000	PC	TB3024C0		1.000	PC	TB3225B0	TB2820A-TAN K-WASHYNG SYS CONNECTION	1.000	PC	TB3252A0	TB3252A0	1.000	PC	TB3614A0	TB3614A0	1.000	PC	VH1220A1	4,2x12 TCB SELF-TAPPIN G SCREW	1.000	PC	VL1019A0	VIBRATION DETERGENT PUMP	1.000	PC	VL1047A1	D6 PIPE HOLDER - D8 J.G. TERMINAL	1.000	PC	VL1102A1	DETERGENT LINE FILTER + BARBED VNR 6 MM	1.000	PC	VL1127A1	6mm BARBED T-SHAPED FITTING	1.000	PC	VL1128A1	D6 BARBED CHECK VALVE	1.000	PC	VL1166A0	BB6-AR6 L FITTING	3.000	PC	VL1174C0	D1.2 MM CALIBRATED NOZZLE	1.000	PC	VL1185A0	2 WAYS PLUS WASHING DISTRIBUTOR	1.000	PC
Code	Description	Qty	UOM																																																																														
RC1356A0	"STRAIGHT THREADED FEMALE END 8x1/4" BS	1.000	PC																																																																														
RC1414A1	D11.5-12.5 SINGLE EAR HOSE CLAMP	5.000	PC																																																																														
TB2821A0	EPDM 6X10 L=40MM PIPE	4.000	PC																																																																														
TB3004A0	TB2820A L=550mm EPDM BLACK PIPE	1.000	PC																																																																														
TB3005B0	TB3132A L=550mm EPDM WHITE-BLUE PIPE	2.000	PC																																																																														
TB3024C0		1.000	PC																																																																														
TB3225B0	TB2820A-TAN K-WASHYNG SYS CONNECTION	1.000	PC																																																																														
TB3252A0	TB3252A0	1.000	PC																																																																														
TB3614A0	TB3614A0	1.000	PC																																																																														
VH1220A1	4,2x12 TCB SELF-TAPPIN G SCREW	1.000	PC																																																																														
VL1019A0	VIBRATION DETERGENT PUMP	1.000	PC																																																																														
VL1047A1	D6 PIPE HOLDER - D8 J.G. TERMINAL	1.000	PC																																																																														
VL1102A1	DETERGENT LINE FILTER + BARBED VNR 6 MM	1.000	PC																																																																														
VL1127A1	6mm BARBED T-SHAPED FITTING	1.000	PC																																																																														
VL1128A1	D6 BARBED CHECK VALVE	1.000	PC																																																																														
VL1166A0	BB6-AR6 L FITTING	3.000	PC																																																																														
VL1174C0	D1.2 MM CALIBRATED NOZZLE	1.000	PC																																																																														
VL1185A0	2 WAYS PLUS WASHING DISTRIBUTOR	1.000	PC																																																																														



COMPONENT			SPARE PART																																																																		
Code	Description	Image	Code	Description	Kit components																																																																
VL1166A	BB6-AR6 L FITTING		KVL1207A	US PLUS 1 ROTOR ARM WASHING SYSTEM KIT	<table border="1"> <thead> <tr> <th>Code</th> <th>Description</th> <th>Qty</th> <th>UOM</th> </tr> </thead> <tbody> <tr> <td>VL1190A0</td> <td>PLUS WASHING SYSTEM INLET DISTRIBUTOR</td> <td>1.000</td> <td>PC</td> </tr> <tr> <td>VL1214A0</td> <td>BAYONET - 6mm BARBED NRV VALVE</td> <td>1.000</td> <td>PC</td> </tr> <tr> <td>VL1398A0</td> <td>1/4 M N.O. CIL PRESSURE SWITCH</td> <td>1.000</td> <td>PC</td> </tr> <tr> <td>VM1605A0</td> <td>CLIP TWIST LOCK DIAM. 10,2-12,7 MM</td> <td>3.000</td> <td>PC</td> </tr> <tr> <td>VM2172A0</td> <td>LOCKING CLIP FOR PUMP WITH CIRCUIT</td> <td>4.000</td> <td>PC</td> </tr> </tbody> </table>	Code	Description	Qty	UOM	VL1190A0	PLUS WASHING SYSTEM INLET DISTRIBUTOR	1.000	PC	VL1214A0	BAYONET - 6mm BARBED NRV VALVE	1.000	PC	VL1398A0	1/4 M N.O. CIL PRESSURE SWITCH	1.000	PC	VM1605A0	CLIP TWIST LOCK DIAM. 10,2-12,7 MM	3.000	PC	VM2172A0	LOCKING CLIP FOR PUMP WITH CIRCUIT	4.000	PC																																								
Code	Description	Qty	UOM																																																																		
VL1190A0	PLUS WASHING SYSTEM INLET DISTRIBUTOR	1.000	PC																																																																		
VL1214A0	BAYONET - 6mm BARBED NRV VALVE	1.000	PC																																																																		
VL1398A0	1/4 M N.O. CIL PRESSURE SWITCH	1.000	PC																																																																		
VM1605A0	CLIP TWIST LOCK DIAM. 10,2-12,7 MM	3.000	PC																																																																		
VM2172A0	LOCKING CLIP FOR PUMP WITH CIRCUIT	4.000	PC																																																																		
			KVL1198A	MM EU HOOD CLEANING SYSTEM KIT	<table border="1"> <thead> <tr> <th>Code</th> <th>Description</th> <th>Qty</th> <th>UOM</th> </tr> </thead> <tbody> <tr> <td>0H2213A1</td> <td>HOOD WATER CIRCUIT PLAT</td> <td>1.000</td> <td>PC</td> </tr> <tr> <td>EL1440A0</td> <td>WATER SELF CLEANING VALVE</td> <td>2.000</td> <td>PC</td> </tr> <tr> <td>GN1526A0</td> <td>INT. D.=6.9 TH=1.8 O-RIN</td> <td>5.000</td> <td>PC</td> </tr> <tr> <td>RC1018A0</td> <td>ZINC PLATED D12 ELASTIC CLAMP</td> <td>1.000</td> <td>PC</td> </tr> <tr> <td>RC1019A0</td> <td>D=10 ELASTIC CLAMP</td> <td>14.000</td> <td>PC</td> </tr> <tr> <td>RC1131A0</td> <td>200x2.6 BLACK CLAMP</td> <td>1.000</td> <td>PC</td> </tr> <tr> <td>RC1242A0</td> <td>D=10 CLOSED CAP</td> <td>2.000</td> <td>PC</td> </tr> <tr> <td>RC1414A1</td> <td>D11.5-12.5 SINGLE EAR HOSE CLAMP</td> <td>3.000</td> <td>PC</td> </tr> <tr> <td>TB2821A0</td> <td>EPDM 6X10 L=40MM PIPE</td> <td>4.000</td> <td>PC</td> </tr> <tr> <td>TB2994A0</td> <td>HOOD DETERGENT PIPE</td> <td>2.000</td> <td>PC</td> </tr> <tr> <td>TB3252A0</td> <td>TB3252A0</td> <td>2.000</td> <td>PC</td> </tr> <tr> <td>TB3614A0</td> <td>TB3614A0</td> <td>1.000</td> <td>PC</td> </tr> <tr> <td>V11220A1</td> <td>4,2x12 TCB SELF-TAPPIN G SCREW</td> <td>3.000</td> <td>PC</td> </tr> <tr> <td>V12070A0</td> <td>SHEETTRACS TCB+ 40x8 SELF-THREAD SCREW</td> <td>2.000</td> <td>PC</td> </tr> <tr> <td>VL1019A0</td> <td>VIBRATION DETERGENT PUMP</td> <td>1.000</td> <td>PC</td> </tr> </tbody> </table>	Code	Description	Qty	UOM	0H2213A1	HOOD WATER CIRCUIT PLAT	1.000	PC	EL1440A0	WATER SELF CLEANING VALVE	2.000	PC	GN1526A0	INT. D.=6.9 TH=1.8 O-RIN	5.000	PC	RC1018A0	ZINC PLATED D12 ELASTIC CLAMP	1.000	PC	RC1019A0	D=10 ELASTIC CLAMP	14.000	PC	RC1131A0	200x2.6 BLACK CLAMP	1.000	PC	RC1242A0	D=10 CLOSED CAP	2.000	PC	RC1414A1	D11.5-12.5 SINGLE EAR HOSE CLAMP	3.000	PC	TB2821A0	EPDM 6X10 L=40MM PIPE	4.000	PC	TB2994A0	HOOD DETERGENT PIPE	2.000	PC	TB3252A0	TB3252A0	2.000	PC	TB3614A0	TB3614A0	1.000	PC	V11220A1	4,2x12 TCB SELF-TAPPIN G SCREW	3.000	PC	V12070A0	SHEETTRACS TCB+ 40x8 SELF-THREAD SCREW	2.000	PC	VL1019A0	VIBRATION DETERGENT PUMP	1.000	PC
Code	Description	Qty	UOM																																																																		
0H2213A1	HOOD WATER CIRCUIT PLAT	1.000	PC																																																																		
EL1440A0	WATER SELF CLEANING VALVE	2.000	PC																																																																		
GN1526A0	INT. D.=6.9 TH=1.8 O-RIN	5.000	PC																																																																		
RC1018A0	ZINC PLATED D12 ELASTIC CLAMP	1.000	PC																																																																		
RC1019A0	D=10 ELASTIC CLAMP	14.000	PC																																																																		
RC1131A0	200x2.6 BLACK CLAMP	1.000	PC																																																																		
RC1242A0	D=10 CLOSED CAP	2.000	PC																																																																		
RC1414A1	D11.5-12.5 SINGLE EAR HOSE CLAMP	3.000	PC																																																																		
TB2821A0	EPDM 6X10 L=40MM PIPE	4.000	PC																																																																		
TB2994A0	HOOD DETERGENT PIPE	2.000	PC																																																																		
TB3252A0	TB3252A0	2.000	PC																																																																		
TB3614A0	TB3614A0	1.000	PC																																																																		
V11220A1	4,2x12 TCB SELF-TAPPIN G SCREW	3.000	PC																																																																		
V12070A0	SHEETTRACS TCB+ 40x8 SELF-THREAD SCREW	2.000	PC																																																																		
VL1019A0	VIBRATION DETERGENT PUMP	1.000	PC																																																																		

COMPONENT			SPARE PART																																																						
Code	Description	Image	Code	Description	Kit components																																																				
VL1166A	BB6-AR6 L FITTING		KVL1198A	MM EU HOOD CLEANING SYSTEM KIT	<table border="1"> <thead> <tr> <th>Code</th> <th>Description</th> <th>Qty</th> <th>UOM</th> </tr> </thead> <tbody> <tr> <td>VL1047A1</td> <td>D6 PIPE HOLDER - D8 J.G. TERMINAL</td> <td>2.000</td> <td>PC</td> </tr> <tr> <td>VL1054B0</td> <td>ONE WASHING SYS INLET DISTRIBUTOR</td> <td>1.000</td> <td>PC</td> </tr> <tr> <td>VL1102A1</td> <td>DETERGENT LINE FILTER + BARBED VNR 6 MM</td> <td>1.000</td> <td>PC</td> </tr> <tr> <td>VL1127A1</td> <td>6mm BARBED T-SHAPED FITTING</td> <td>1.000</td> <td>PC</td> </tr> <tr> <td>VL1128A1</td> <td>D6 BARBED CHECK VALVE</td> <td>1.000</td> <td>PC</td> </tr> <tr> <td>VL1165A0</td> <td>BAM-BB6 STRAIGHT FITTING</td> <td>1.000</td> <td>PC</td> </tr> <tr> <td>VL1166A0</td> <td>BB6-AR6 L FITTING</td> <td>2.000</td> <td>PC</td> </tr> <tr> <td>VL1174C0</td> <td>D1.2 MM CALIBRATED NOZZLE</td> <td>1.000</td> <td>PC</td> </tr> <tr> <td>VL1191A0</td> <td>ONE WASHING DISTRIBUTOR OUTLETS KIT</td> <td>1.000</td> <td>PC</td> </tr> <tr> <td>VL1214A0</td> <td>BAYONET - 6mm BARBED NRV VALVE</td> <td>1.000</td> <td>PC</td> </tr> <tr> <td>VM1605A0</td> <td>CLIP TWIST LOCK DIAM. 10,2-12,7 MM</td> <td>2.000</td> <td>PC</td> </tr> <tr> <td>VM2172A0</td> <td>LOCKING CLIP FOR PUMP WITH CIRCUIT</td> <td>3.000</td> <td>PC</td> </tr> </tbody> </table>	Code	Description	Qty	UOM	VL1047A1	D6 PIPE HOLDER - D8 J.G. TERMINAL	2.000	PC	VL1054B0	ONE WASHING SYS INLET DISTRIBUTOR	1.000	PC	VL1102A1	DETERGENT LINE FILTER + BARBED VNR 6 MM	1.000	PC	VL1127A1	6mm BARBED T-SHAPED FITTING	1.000	PC	VL1128A1	D6 BARBED CHECK VALVE	1.000	PC	VL1165A0	BAM-BB6 STRAIGHT FITTING	1.000	PC	VL1166A0	BB6-AR6 L FITTING	2.000	PC	VL1174C0	D1.2 MM CALIBRATED NOZZLE	1.000	PC	VL1191A0	ONE WASHING DISTRIBUTOR OUTLETS KIT	1.000	PC	VL1214A0	BAYONET - 6mm BARBED NRV VALVE	1.000	PC	VM1605A0	CLIP TWIST LOCK DIAM. 10,2-12,7 MM	2.000	PC	VM2172A0	LOCKING CLIP FOR PUMP WITH CIRCUIT	3.000	PC
Code	Description	Qty	UOM																																																						
VL1047A1	D6 PIPE HOLDER - D8 J.G. TERMINAL	2.000	PC																																																						
VL1054B0	ONE WASHING SYS INLET DISTRIBUTOR	1.000	PC																																																						
VL1102A1	DETERGENT LINE FILTER + BARBED VNR 6 MM	1.000	PC																																																						
VL1127A1	6mm BARBED T-SHAPED FITTING	1.000	PC																																																						
VL1128A1	D6 BARBED CHECK VALVE	1.000	PC																																																						
VL1165A0	BAM-BB6 STRAIGHT FITTING	1.000	PC																																																						
VL1166A0	BB6-AR6 L FITTING	2.000	PC																																																						
VL1174C0	D1.2 MM CALIBRATED NOZZLE	1.000	PC																																																						
VL1191A0	ONE WASHING DISTRIBUTOR OUTLETS KIT	1.000	PC																																																						
VL1214A0	BAYONET - 6mm BARBED NRV VALVE	1.000	PC																																																						
VM1605A0	CLIP TWIST LOCK DIAM. 10,2-12,7 MM	2.000	PC																																																						
VM2172A0	LOCKING CLIP FOR PUMP WITH CIRCUIT	3.000	PC																																																						
			KVL1187A	3 ROTOR ARMS PLUS EU CLEANING SYSTEM KIT	<table border="1"> <thead> <tr> <th>Code</th> <th>Description</th> <th>Qty</th> <th>UOM</th> </tr> </thead> <tbody> <tr> <td>0H2354A1</td> <td>XEVC-XEVL PLUS WASHING CIRCUIT PLAT</td> <td>1.000</td> <td>PC</td> </tr> <tr> <td>EL1440A0</td> <td>WATER SELF CLEANING VALVE</td> <td>4.000</td> <td>PC</td> </tr> <tr> <td>GN1526A0</td> <td>INT. D.=6.9 TH=1.8 O-RIN</td> <td>9.000</td> <td>PC</td> </tr> <tr> <td>RC1018A0</td> <td>ZINC PLATED D12 ELASTIC CLAMP</td> <td>11.000</td> <td>PC</td> </tr> <tr> <td>RC1019A0</td> <td>D=10 ELASTIC CLAMP</td> <td>14.000</td> <td>PC</td> </tr> <tr> <td>RC1130A0</td> <td>130x2,6 CLAM</td> <td>1.000</td> <td>PC</td> </tr> </tbody> </table>	Code	Description	Qty	UOM	0H2354A1	XEVC-XEVL PLUS WASHING CIRCUIT PLAT	1.000	PC	EL1440A0	WATER SELF CLEANING VALVE	4.000	PC	GN1526A0	INT. D.=6.9 TH=1.8 O-RIN	9.000	PC	RC1018A0	ZINC PLATED D12 ELASTIC CLAMP	11.000	PC	RC1019A0	D=10 ELASTIC CLAMP	14.000	PC	RC1130A0	130x2,6 CLAM	1.000	PC																								
Code	Description	Qty	UOM																																																						
0H2354A1	XEVC-XEVL PLUS WASHING CIRCUIT PLAT	1.000	PC																																																						
EL1440A0	WATER SELF CLEANING VALVE	4.000	PC																																																						
GN1526A0	INT. D.=6.9 TH=1.8 O-RIN	9.000	PC																																																						
RC1018A0	ZINC PLATED D12 ELASTIC CLAMP	11.000	PC																																																						
RC1019A0	D=10 ELASTIC CLAMP	14.000	PC																																																						
RC1130A0	130x2,6 CLAM	1.000	PC																																																						



COMPONENT			SPARE PART																																																																																										
Code	Description	Image	Code	Description	Kit components																																																																																								
VL1166A	BB6-AR6 L FITTING		KVL1187A	3 ROTOR ARMS PLUS EU CLEANING SYSTEM KIT	<table border="1"> <thead> <tr> <th>Code</th> <th>Description</th> <th>Qty</th> <th>UOM</th> </tr> </thead> <tbody> <tr> <td>RC1131A0</td> <td>200x2.6 BLACK CLAMP</td> <td>3.000</td> <td>PC</td> </tr> <tr> <td>RC1242A0</td> <td>D=10 CLOSED CAP</td> <td>2.000</td> <td>PC</td> </tr> <tr> <td>RC1356A0</td> <td>"STRAIGHT THREADED FEMALE END 8x1/4" BS</td> <td>1.000</td> <td>PC</td> </tr> <tr> <td>RC1414A1</td> <td>D11.5-12.5 SINGLE EAR HOSE CLAMP</td> <td>1.000</td> <td>PC</td> </tr> <tr> <td>TB2652A0</td> <td></td> <td>1.000</td> <td>PC</td> </tr> <tr> <td>TB2677A0</td> <td></td> <td>1.000</td> <td>PC</td> </tr> <tr> <td>TB2821A0</td> <td>EPDM 6X10 L=40MM PIPE</td> <td>4.000</td> <td>PC</td> </tr> <tr> <td>TB3004A0</td> <td>TB2820A L=550mm EPDM BLACK PIPE</td> <td>2.000</td> <td>PC</td> </tr> <tr> <td>TB3024C0</td> <td></td> <td>3.000</td> <td>PC</td> </tr> <tr> <td>TB3226A0</td> <td></td> <td>1.000</td> <td>PC</td> </tr> <tr> <td>TB3440A0</td> <td>TB3132A L=1050mm EPDM WHITE-BLUE PIPE</td> <td>1.000</td> <td>PC</td> </tr> <tr> <td>TB3614A0</td> <td>TB3614A0</td> <td>1.000</td> <td>PC</td> </tr> <tr> <td>VI1220A1</td> <td>4,2x12 TCB SELF-TAPPING SCREW</td> <td>1.000</td> <td>PC</td> </tr> <tr> <td>VL1019A0</td> <td>VIBRATION DETERGENT PUMP</td> <td>1.000</td> <td>PC</td> </tr> <tr> <td>VL1047A1</td> <td>D6 PIPE HOLDER - D8 J.G. TERMINAL</td> <td>1.000</td> <td>PC</td> </tr> <tr> <td>VL1065A1</td> <td>1/4 MALE N.O. PRESSURE SWITCH</td> <td>1.000</td> <td>PC</td> </tr> <tr> <td>VL1102A1</td> <td>DETERGENT LINE FILTER + BARBED VNR 6 MM</td> <td>1.000</td> <td>PC</td> </tr> <tr> <td>VL1127A1</td> <td>6mm BARBED T-SHAPED FITTING</td> <td>2.000</td> <td>PC</td> </tr> <tr> <td>VL1128A1</td> <td>D6 BARBED CHECK VALVE</td> <td>2.000</td> <td>PC</td> </tr> <tr> <td>VL1166A0</td> <td>BB6-AR6 L FITTING</td> <td>4.000</td> <td>PC</td> </tr> <tr> <td>VL1167A2</td> <td>GN21 3 ROTOR ARMS B-B FLOW RESTRICTOR</td> <td>1.000</td> <td>PC</td> </tr> </tbody> </table>	Code	Description	Qty	UOM	RC1131A0	200x2.6 BLACK CLAMP	3.000	PC	RC1242A0	D=10 CLOSED CAP	2.000	PC	RC1356A0	"STRAIGHT THREADED FEMALE END 8x1/4" BS	1.000	PC	RC1414A1	D11.5-12.5 SINGLE EAR HOSE CLAMP	1.000	PC	TB2652A0		1.000	PC	TB2677A0		1.000	PC	TB2821A0	EPDM 6X10 L=40MM PIPE	4.000	PC	TB3004A0	TB2820A L=550mm EPDM BLACK PIPE	2.000	PC	TB3024C0		3.000	PC	TB3226A0		1.000	PC	TB3440A0	TB3132A L=1050mm EPDM WHITE-BLUE PIPE	1.000	PC	TB3614A0	TB3614A0	1.000	PC	VI1220A1	4,2x12 TCB SELF-TAPPING SCREW	1.000	PC	VL1019A0	VIBRATION DETERGENT PUMP	1.000	PC	VL1047A1	D6 PIPE HOLDER - D8 J.G. TERMINAL	1.000	PC	VL1065A1	1/4 MALE N.O. PRESSURE SWITCH	1.000	PC	VL1102A1	DETERGENT LINE FILTER + BARBED VNR 6 MM	1.000	PC	VL1127A1	6mm BARBED T-SHAPED FITTING	2.000	PC	VL1128A1	D6 BARBED CHECK VALVE	2.000	PC	VL1166A0	BB6-AR6 L FITTING	4.000	PC	VL1167A2	GN21 3 ROTOR ARMS B-B FLOW RESTRICTOR	1.000	PC
Code	Description	Qty	UOM																																																																																										
RC1131A0	200x2.6 BLACK CLAMP	3.000	PC																																																																																										
RC1242A0	D=10 CLOSED CAP	2.000	PC																																																																																										
RC1356A0	"STRAIGHT THREADED FEMALE END 8x1/4" BS	1.000	PC																																																																																										
RC1414A1	D11.5-12.5 SINGLE EAR HOSE CLAMP	1.000	PC																																																																																										
TB2652A0		1.000	PC																																																																																										
TB2677A0		1.000	PC																																																																																										
TB2821A0	EPDM 6X10 L=40MM PIPE	4.000	PC																																																																																										
TB3004A0	TB2820A L=550mm EPDM BLACK PIPE	2.000	PC																																																																																										
TB3024C0		3.000	PC																																																																																										
TB3226A0		1.000	PC																																																																																										
TB3440A0	TB3132A L=1050mm EPDM WHITE-BLUE PIPE	1.000	PC																																																																																										
TB3614A0	TB3614A0	1.000	PC																																																																																										
VI1220A1	4,2x12 TCB SELF-TAPPING SCREW	1.000	PC																																																																																										
VL1019A0	VIBRATION DETERGENT PUMP	1.000	PC																																																																																										
VL1047A1	D6 PIPE HOLDER - D8 J.G. TERMINAL	1.000	PC																																																																																										
VL1065A1	1/4 MALE N.O. PRESSURE SWITCH	1.000	PC																																																																																										
VL1102A1	DETERGENT LINE FILTER + BARBED VNR 6 MM	1.000	PC																																																																																										
VL1127A1	6mm BARBED T-SHAPED FITTING	2.000	PC																																																																																										
VL1128A1	D6 BARBED CHECK VALVE	2.000	PC																																																																																										
VL1166A0	BB6-AR6 L FITTING	4.000	PC																																																																																										
VL1167A2	GN21 3 ROTOR ARMS B-B FLOW RESTRICTOR	1.000	PC																																																																																										



COMPONENT			SPARE PART																																																						
Code	Description	Image	Code	Description	Kit components																																																				
VL1166A	BB6-AR6 L FITTING		KVL1187A	3 ROTOR ARMS PLUS EU CLEANING SYSTEM KIT	<table border="1"> <thead> <tr> <th>Code</th> <th>Description</th> <th>Qty</th> <th>UOM</th> </tr> </thead> <tbody> <tr> <td>VL1174C0</td> <td>D1.2 MM CALIBRATED NOZZLE</td> <td>1.000</td> <td>PC</td> </tr> <tr> <td>VL1186A0</td> <td>3 WAYS PLUS WASHING DISTRIBUTOR</td> <td>1.000</td> <td>PC</td> </tr> <tr> <td>VL1190A0</td> <td>PLUS WASHING SYSTEM INLET DISTRIBUTOR</td> <td>1.000</td> <td>PC</td> </tr> <tr> <td>VL1214A0</td> <td>BAYONET - 6mm BARBED NRV VALVE</td> <td>1.000</td> <td>PC</td> </tr> <tr> <td>VM1605A0</td> <td>CLIP TWIST LOCK DIAM. 10,2-12,7 MM</td> <td>3.000</td> <td>PC</td> </tr> <tr> <td>VM2172A0</td> <td>LOCKING CLIP FOR PUMP WITH CIRCUIT</td> <td>5.000</td> <td>PC</td> </tr> </tbody> </table>	Code	Description	Qty	UOM	VL1174C0	D1.2 MM CALIBRATED NOZZLE	1.000	PC	VL1186A0	3 WAYS PLUS WASHING DISTRIBUTOR	1.000	PC	VL1190A0	PLUS WASHING SYSTEM INLET DISTRIBUTOR	1.000	PC	VL1214A0	BAYONET - 6mm BARBED NRV VALVE	1.000	PC	VM1605A0	CLIP TWIST LOCK DIAM. 10,2-12,7 MM	3.000	PC	VM2172A0	LOCKING CLIP FOR PUMP WITH CIRCUIT	5.000	PC																								
Code	Description	Qty	UOM																																																						
VL1174C0	D1.2 MM CALIBRATED NOZZLE	1.000	PC																																																						
VL1186A0	3 WAYS PLUS WASHING DISTRIBUTOR	1.000	PC																																																						
VL1190A0	PLUS WASHING SYSTEM INLET DISTRIBUTOR	1.000	PC																																																						
VL1214A0	BAYONET - 6mm BARBED NRV VALVE	1.000	PC																																																						
VM1605A0	CLIP TWIST LOCK DIAM. 10,2-12,7 MM	3.000	PC																																																						
VM2172A0	LOCKING CLIP FOR PUMP WITH CIRCUIT	5.000	PC																																																						
			KVL1184A	2 ROTOR ARMS PLUS EU CLEANING SYSTEM KIT	<table border="1"> <thead> <tr> <th>Code</th> <th>Description</th> <th>Qty</th> <th>UOM</th> </tr> </thead> <tbody> <tr> <td>0H2354A1</td> <td>XEVC-XEVL PLUS WASHING CIRCUIT PLAT</td> <td>1.000</td> <td>PC</td> </tr> <tr> <td>EL1440A0</td> <td>WATER SELF CLEANING VALVE</td> <td>4.000</td> <td>PC</td> </tr> <tr> <td>GN1526A0</td> <td>INT. D.=6.9 TH=1.8 O-RIN</td> <td>9.000</td> <td>PC</td> </tr> <tr> <td>RC1018A0</td> <td>ZINC PLATED D12 ELASTIC CLAMP</td> <td>2.000</td> <td>PC</td> </tr> <tr> <td>RC1019A0</td> <td>D=10 ELASTIC CLAMP</td> <td>13.000</td> <td>PC</td> </tr> <tr> <td>RC1130A0</td> <td>130x2.6 CLAM</td> <td>1.000</td> <td>PC</td> </tr> <tr> <td>RC1131A0</td> <td>200x2.6 BLACK CLAMP</td> <td>3.000</td> <td>PC</td> </tr> <tr> <td>RC1242A0</td> <td>D=10 CLOSED CAP</td> <td>2.000</td> <td>PC</td> </tr> <tr> <td>RC1356A0</td> <td>"STRAIGHT THREADED FEMALE END 8x1/4" BS</td> <td>1.000</td> <td>PC</td> </tr> <tr> <td>RC1414A1</td> <td>D11.5-12.5 SINGLE EAR HOSE CLAMP</td> <td>1.000</td> <td>PC</td> </tr> <tr> <td>TB2821A0</td> <td>EPDM 6X10 L=40MM PIPE</td> <td>4.000</td> <td>PC</td> </tr> <tr> <td>TB2994A0</td> <td>HOOD DETERGENT PIPE</td> <td>1.000</td> <td>PC</td> </tr> </tbody> </table>	Code	Description	Qty	UOM	0H2354A1	XEVC-XEVL PLUS WASHING CIRCUIT PLAT	1.000	PC	EL1440A0	WATER SELF CLEANING VALVE	4.000	PC	GN1526A0	INT. D.=6.9 TH=1.8 O-RIN	9.000	PC	RC1018A0	ZINC PLATED D12 ELASTIC CLAMP	2.000	PC	RC1019A0	D=10 ELASTIC CLAMP	13.000	PC	RC1130A0	130x2.6 CLAM	1.000	PC	RC1131A0	200x2.6 BLACK CLAMP	3.000	PC	RC1242A0	D=10 CLOSED CAP	2.000	PC	RC1356A0	"STRAIGHT THREADED FEMALE END 8x1/4" BS	1.000	PC	RC1414A1	D11.5-12.5 SINGLE EAR HOSE CLAMP	1.000	PC	TB2821A0	EPDM 6X10 L=40MM PIPE	4.000	PC	TB2994A0	HOOD DETERGENT PIPE	1.000	PC
Code	Description	Qty	UOM																																																						
0H2354A1	XEVC-XEVL PLUS WASHING CIRCUIT PLAT	1.000	PC																																																						
EL1440A0	WATER SELF CLEANING VALVE	4.000	PC																																																						
GN1526A0	INT. D.=6.9 TH=1.8 O-RIN	9.000	PC																																																						
RC1018A0	ZINC PLATED D12 ELASTIC CLAMP	2.000	PC																																																						
RC1019A0	D=10 ELASTIC CLAMP	13.000	PC																																																						
RC1130A0	130x2.6 CLAM	1.000	PC																																																						
RC1131A0	200x2.6 BLACK CLAMP	3.000	PC																																																						
RC1242A0	D=10 CLOSED CAP	2.000	PC																																																						
RC1356A0	"STRAIGHT THREADED FEMALE END 8x1/4" BS	1.000	PC																																																						
RC1414A1	D11.5-12.5 SINGLE EAR HOSE CLAMP	1.000	PC																																																						
TB2821A0	EPDM 6X10 L=40MM PIPE	4.000	PC																																																						
TB2994A0	HOOD DETERGENT PIPE	1.000	PC																																																						

COMPONENT			SPARE PART																																																																											
Code	Description	Image	Code	Description	Kit components																																																																									
VL1166A	BB6-AR6 L FITTING		KVL1184A	2 ROTOR ARMS PLUS EU CLEANING SYSTEM KIT	<table border="1"> <thead> <tr> <th>Code</th> <th>Description</th> <th>Qty</th> <th>UOM</th> </tr> </thead> <tbody> <tr> <td>TB3004A0</td> <td>TB2820A L=550mm EPDM BLACK PIPE</td> <td>2.000</td> <td>PC</td> </tr> <tr> <td>TB3005B0</td> <td>TB3132A L=550mm EPDM WHITE-BLUE PIPE</td> <td>1.000</td> <td>PC</td> </tr> <tr> <td>TB3440A0</td> <td>TB3132A L=1050mm EPDM WHITE-BLUE PIPE</td> <td>1.000</td> <td>PC</td> </tr> <tr> <td>TB3614A0</td> <td>TB3614A0</td> <td>1.000</td> <td>PC</td> </tr> <tr> <td>VI1220A1</td> <td>4,2x12 TCB SELF-TAPPIN G SCREW</td> <td>1.000</td> <td>PC</td> </tr> <tr> <td>VL1019A0</td> <td>VIBRATION DETERGENT PUMP</td> <td>1.000</td> <td>PC</td> </tr> <tr> <td>VL1047A1</td> <td>D6 PIPE HOLDER - D8 J.G. TERMINAL</td> <td>1.000</td> <td>PC</td> </tr> <tr> <td>VL1065A1</td> <td>1/4 MALE N.O. PRESSURE SWITCH</td> <td>1.000</td> <td>PC</td> </tr> <tr> <td>VL1102A1</td> <td>DETERGENT LINE FILTER + BARBED VNR 6 MM</td> <td>1.000</td> <td>PC</td> </tr> <tr> <td>VL1128A1</td> <td>D6 BARBED CHECK VALVE</td> <td>1.000</td> <td>PC</td> </tr> <tr> <td>VL1166A0</td> <td>BB6-AR6 L FITTING</td> <td>4.000</td> <td>PC</td> </tr> <tr> <td>VL1174C0</td> <td>D1.2 MM CALIBRATED NOZZLE</td> <td>1.000</td> <td>PC</td> </tr> <tr> <td>VL1186A0</td> <td>3 WAYS PLUS WASHING DISTRIBUTOR</td> <td>1.000</td> <td>PC</td> </tr> <tr> <td>VL1190A0</td> <td>PLUS WASHING SYSTEM INLET DISTRIBUTOR</td> <td>1.000</td> <td>PC</td> </tr> <tr> <td>VL1214A0</td> <td>BAYONET - 6mm BARBED NRV VALVE</td> <td>1.000</td> <td>PC</td> </tr> <tr> <td>VM1605A0</td> <td>CLIP TWIST LOCK DIAM. 10,2-12,7 MM</td> <td>3.000</td> <td>PC</td> </tr> <tr> <td>VM2172A0</td> <td>LOCKING CLIP FOR PUMP WITH CIRCUIT</td> <td>5.000</td> <td>PC</td> </tr> </tbody> </table>	Code	Description	Qty	UOM	TB3004A0	TB2820A L=550mm EPDM BLACK PIPE	2.000	PC	TB3005B0	TB3132A L=550mm EPDM WHITE-BLUE PIPE	1.000	PC	TB3440A0	TB3132A L=1050mm EPDM WHITE-BLUE PIPE	1.000	PC	TB3614A0	TB3614A0	1.000	PC	VI1220A1	4,2x12 TCB SELF-TAPPIN G SCREW	1.000	PC	VL1019A0	VIBRATION DETERGENT PUMP	1.000	PC	VL1047A1	D6 PIPE HOLDER - D8 J.G. TERMINAL	1.000	PC	VL1065A1	1/4 MALE N.O. PRESSURE SWITCH	1.000	PC	VL1102A1	DETERGENT LINE FILTER + BARBED VNR 6 MM	1.000	PC	VL1128A1	D6 BARBED CHECK VALVE	1.000	PC	VL1166A0	BB6-AR6 L FITTING	4.000	PC	VL1174C0	D1.2 MM CALIBRATED NOZZLE	1.000	PC	VL1186A0	3 WAYS PLUS WASHING DISTRIBUTOR	1.000	PC	VL1190A0	PLUS WASHING SYSTEM INLET DISTRIBUTOR	1.000	PC	VL1214A0	BAYONET - 6mm BARBED NRV VALVE	1.000	PC	VM1605A0	CLIP TWIST LOCK DIAM. 10,2-12,7 MM	3.000	PC	VM2172A0	LOCKING CLIP FOR PUMP WITH CIRCUIT	5.000	PC	
Code	Description	Qty	UOM																																																																											
TB3004A0	TB2820A L=550mm EPDM BLACK PIPE	2.000	PC																																																																											
TB3005B0	TB3132A L=550mm EPDM WHITE-BLUE PIPE	1.000	PC																																																																											
TB3440A0	TB3132A L=1050mm EPDM WHITE-BLUE PIPE	1.000	PC																																																																											
TB3614A0	TB3614A0	1.000	PC																																																																											
VI1220A1	4,2x12 TCB SELF-TAPPIN G SCREW	1.000	PC																																																																											
VL1019A0	VIBRATION DETERGENT PUMP	1.000	PC																																																																											
VL1047A1	D6 PIPE HOLDER - D8 J.G. TERMINAL	1.000	PC																																																																											
VL1065A1	1/4 MALE N.O. PRESSURE SWITCH	1.000	PC																																																																											
VL1102A1	DETERGENT LINE FILTER + BARBED VNR 6 MM	1.000	PC																																																																											
VL1128A1	D6 BARBED CHECK VALVE	1.000	PC																																																																											
VL1166A0	BB6-AR6 L FITTING	4.000	PC																																																																											
VL1174C0	D1.2 MM CALIBRATED NOZZLE	1.000	PC																																																																											
VL1186A0	3 WAYS PLUS WASHING DISTRIBUTOR	1.000	PC																																																																											
VL1190A0	PLUS WASHING SYSTEM INLET DISTRIBUTOR	1.000	PC																																																																											
VL1214A0	BAYONET - 6mm BARBED NRV VALVE	1.000	PC																																																																											
VM1605A0	CLIP TWIST LOCK DIAM. 10,2-12,7 MM	3.000	PC																																																																											
VM2172A0	LOCKING CLIP FOR PUMP WITH CIRCUIT	5.000	PC																																																																											



COMPONENT			SPARE PART																																																																																		
Code	Description	Image	Code	Description	Kit components																																																																																
VL1166A	BB6-AR6 L FITTING		KVL1183A	1 ROTOR ARM PLUS CLEANING SYSTEM KIT	<table border="1"> <thead> <tr> <th>Code</th> <th>Description</th> <th>Qty</th> <th>UOM</th> </tr> </thead> <tbody> <tr> <td>0H2354A1</td> <td>XEVC-XEVL PLUS WASHING CIRCUIT PLAT</td> <td>1.000</td> <td>PC</td> </tr> <tr> <td>EL1440A0</td> <td>WATER SELF CLEANING VALVE</td> <td>3.000</td> <td>PC</td> </tr> <tr> <td>GN1526A0</td> <td>INT. D.=6.9 TH=1.8 O-RIN</td> <td>7.000</td> <td>PC</td> </tr> <tr> <td>RC1018A0</td> <td>ZINC PLATED D12 ELASTIC CLAMP</td> <td>1.000</td> <td>PC</td> </tr> <tr> <td>RC1019A0</td> <td>D=10 ELASTIC CLAMP</td> <td>12.000</td> <td>PC</td> </tr> <tr> <td>RC1130A0</td> <td>130x2.6 CLAM</td> <td>1.000</td> <td>PC</td> </tr> <tr> <td>RC1131A0</td> <td>200x2.6 BLACK CLAMP</td> <td>2.000</td> <td>PC</td> </tr> <tr> <td>RC1242A0</td> <td>D=10 CLOSED CAP</td> <td>2.000</td> <td>PC</td> </tr> <tr> <td>RC1356A0</td> <td>"STRAIGHT THREADED FEMALE END 8x1/4" BS</td> <td>1.000</td> <td>PC</td> </tr> <tr> <td>RC1414A1</td> <td>D11.5-12.5 SINGLE EAR HOSE CLAMP</td> <td>1.000</td> <td>PC</td> </tr> <tr> <td>TB2821A0</td> <td>EPDM 6X10 L=40MM PIPE</td> <td>4.000</td> <td>PC</td> </tr> <tr> <td>TB3004A0</td> <td>TB2820A L=550mm EPDM BLACK PIPE</td> <td>1.000</td> <td>PC</td> </tr> <tr> <td>TB3005B0</td> <td>TB3132A L=550mm EPDM WHITE-BLUE PIPE</td> <td>1.000</td> <td>PC</td> </tr> <tr> <td>TB3225B0</td> <td>TB2820A-TAN K-WASHYNG SYS CONNECTION</td> <td>1.000</td> <td>PC</td> </tr> <tr> <td>TB3252A0</td> <td>TB3252A0</td> <td>1.000</td> <td>PC</td> </tr> <tr> <td>TB3614A0</td> <td>TB3614A0</td> <td>1.000</td> <td>PC</td> </tr> <tr> <td>VH1220A1</td> <td>4,2x12 TCB SELF-TAPPIN G SCREW</td> <td>1.000</td> <td>PC</td> </tr> <tr> <td>VL1019A0</td> <td>VIBRATION DETERGENT PUMP</td> <td>1.000</td> <td>PC</td> </tr> <tr> <td>VL1047A1</td> <td>D6 PIPE HOLDER - D8 J.G. TERMINAL</td> <td>1.000</td> <td>PC</td> </tr> </tbody> </table>	Code	Description	Qty	UOM	0H2354A1	XEVC-XEVL PLUS WASHING CIRCUIT PLAT	1.000	PC	EL1440A0	WATER SELF CLEANING VALVE	3.000	PC	GN1526A0	INT. D.=6.9 TH=1.8 O-RIN	7.000	PC	RC1018A0	ZINC PLATED D12 ELASTIC CLAMP	1.000	PC	RC1019A0	D=10 ELASTIC CLAMP	12.000	PC	RC1130A0	130x2.6 CLAM	1.000	PC	RC1131A0	200x2.6 BLACK CLAMP	2.000	PC	RC1242A0	D=10 CLOSED CAP	2.000	PC	RC1356A0	"STRAIGHT THREADED FEMALE END 8x1/4" BS	1.000	PC	RC1414A1	D11.5-12.5 SINGLE EAR HOSE CLAMP	1.000	PC	TB2821A0	EPDM 6X10 L=40MM PIPE	4.000	PC	TB3004A0	TB2820A L=550mm EPDM BLACK PIPE	1.000	PC	TB3005B0	TB3132A L=550mm EPDM WHITE-BLUE PIPE	1.000	PC	TB3225B0	TB2820A-TAN K-WASHYNG SYS CONNECTION	1.000	PC	TB3252A0	TB3252A0	1.000	PC	TB3614A0	TB3614A0	1.000	PC	VH1220A1	4,2x12 TCB SELF-TAPPIN G SCREW	1.000	PC	VL1019A0	VIBRATION DETERGENT PUMP	1.000	PC	VL1047A1	D6 PIPE HOLDER - D8 J.G. TERMINAL	1.000	PC
Code	Description	Qty	UOM																																																																																		
0H2354A1	XEVC-XEVL PLUS WASHING CIRCUIT PLAT	1.000	PC																																																																																		
EL1440A0	WATER SELF CLEANING VALVE	3.000	PC																																																																																		
GN1526A0	INT. D.=6.9 TH=1.8 O-RIN	7.000	PC																																																																																		
RC1018A0	ZINC PLATED D12 ELASTIC CLAMP	1.000	PC																																																																																		
RC1019A0	D=10 ELASTIC CLAMP	12.000	PC																																																																																		
RC1130A0	130x2.6 CLAM	1.000	PC																																																																																		
RC1131A0	200x2.6 BLACK CLAMP	2.000	PC																																																																																		
RC1242A0	D=10 CLOSED CAP	2.000	PC																																																																																		
RC1356A0	"STRAIGHT THREADED FEMALE END 8x1/4" BS	1.000	PC																																																																																		
RC1414A1	D11.5-12.5 SINGLE EAR HOSE CLAMP	1.000	PC																																																																																		
TB2821A0	EPDM 6X10 L=40MM PIPE	4.000	PC																																																																																		
TB3004A0	TB2820A L=550mm EPDM BLACK PIPE	1.000	PC																																																																																		
TB3005B0	TB3132A L=550mm EPDM WHITE-BLUE PIPE	1.000	PC																																																																																		
TB3225B0	TB2820A-TAN K-WASHYNG SYS CONNECTION	1.000	PC																																																																																		
TB3252A0	TB3252A0	1.000	PC																																																																																		
TB3614A0	TB3614A0	1.000	PC																																																																																		
VH1220A1	4,2x12 TCB SELF-TAPPIN G SCREW	1.000	PC																																																																																		
VL1019A0	VIBRATION DETERGENT PUMP	1.000	PC																																																																																		
VL1047A1	D6 PIPE HOLDER - D8 J.G. TERMINAL	1.000	PC																																																																																		







COMPONENT			SPARE PART																																														
Code	Description	Image	Code	Description	Kit components																																												
VL1166A	BB6-AR6 L FITTING		KVL1183A	1 ROTOR ARM PLUS CLEANING SYSTEM KIT	<table border="1"> <thead> <tr> <th>Code</th> <th>Description</th> <th>Qty</th> <th>UOM</th> </tr> </thead> <tbody> <tr> <td>VL1102A1</td> <td>DETERGENT LINE FILTER + BARBED VNR 6 MM</td> <td>1.000</td> <td>PC</td> </tr> <tr> <td>VL1128A1</td> <td>D6 BARBED CHECK VALVE</td> <td>1.000</td> <td>PC</td> </tr> <tr> <td>VL1166A0</td> <td>BB6-AR6 L FITTING</td> <td>3.000</td> <td>PC</td> </tr> <tr> <td>VL1174C0</td> <td>D1.2 MM CALIBRATED NOZZLE</td> <td>1.000</td> <td>PC</td> </tr> <tr> <td>VL1185A0</td> <td>2 WAYS PLUS WASHING DISTRIBUTOR</td> <td>1.000</td> <td>PC</td> </tr> <tr> <td>VL1190A0</td> <td>PLUS WASHING SYSTEM INLET DISTRIBUTOR</td> <td>1.000</td> <td>PC</td> </tr> <tr> <td>VL1214A0</td> <td>BAYONET - 6mm BARBED NRV VALVE</td> <td>1.000</td> <td>PC</td> </tr> <tr> <td>VL1398A0</td> <td>1/4 M N.O. CIL PRESSURE SWITCH</td> <td>1.000</td> <td>PC</td> </tr> <tr> <td>VM1605A0</td> <td>CLIP TWIST LOCK DIAM. 10,2-12,7 MM</td> <td>3.000</td> <td>PC</td> </tr> <tr> <td>VM2172A0</td> <td>LOCKING CLIP FOR PUMP WITH CIRCUIT</td> <td>4.000</td> <td>PC</td> </tr> </tbody> </table>	Code	Description	Qty	UOM	VL1102A1	DETERGENT LINE FILTER + BARBED VNR 6 MM	1.000	PC	VL1128A1	D6 BARBED CHECK VALVE	1.000	PC	VL1166A0	BB6-AR6 L FITTING	3.000	PC	VL1174C0	D1.2 MM CALIBRATED NOZZLE	1.000	PC	VL1185A0	2 WAYS PLUS WASHING DISTRIBUTOR	1.000	PC	VL1190A0	PLUS WASHING SYSTEM INLET DISTRIBUTOR	1.000	PC	VL1214A0	BAYONET - 6mm BARBED NRV VALVE	1.000	PC	VL1398A0	1/4 M N.O. CIL PRESSURE SWITCH	1.000	PC	VM1605A0	CLIP TWIST LOCK DIAM. 10,2-12,7 MM	3.000	PC	VM2172A0	LOCKING CLIP FOR PUMP WITH CIRCUIT	4.000	PC
Code	Description	Qty	UOM																																														
VL1102A1	DETERGENT LINE FILTER + BARBED VNR 6 MM	1.000	PC																																														
VL1128A1	D6 BARBED CHECK VALVE	1.000	PC																																														
VL1166A0	BB6-AR6 L FITTING	3.000	PC																																														
VL1174C0	D1.2 MM CALIBRATED NOZZLE	1.000	PC																																														
VL1185A0	2 WAYS PLUS WASHING DISTRIBUTOR	1.000	PC																																														
VL1190A0	PLUS WASHING SYSTEM INLET DISTRIBUTOR	1.000	PC																																														
VL1214A0	BAYONET - 6mm BARBED NRV VALVE	1.000	PC																																														
VL1398A0	1/4 M N.O. CIL PRESSURE SWITCH	1.000	PC																																														
VM1605A0	CLIP TWIST LOCK DIAM. 10,2-12,7 MM	3.000	PC																																														
VM2172A0	LOCKING CLIP FOR PUMP WITH CIRCUIT	4.000	PC																																														
			KVL1182A	ONE 1ROT CLEANING SYSTEM KIT (0311 EXC.)	<table border="1"> <thead> <tr> <th>Code</th> <th>Description</th> <th>Qty</th> <th>UOM</th> </tr> </thead> <tbody> <tr> <td>0H2202A1</td> <td>ONE WASHING WITH STEAM VALVE SUPPORT</td> <td>1.000</td> <td>PC</td> </tr> <tr> <td>EL1440A0</td> <td>WATER SELF CLEANING VALVE</td> <td>1.000</td> <td>PC</td> </tr> <tr> <td>GN1526A0</td> <td>INT. D.=6.9 TH=1.8 O-RIN</td> <td>3.000</td> <td>PC</td> </tr> <tr> <td>RC1019A0</td> <td>D=10 ELASTIC CLAMP</td> <td>12.000</td> <td>PC</td> </tr> <tr> <td>RC1242A0</td> <td>D=10 CLOSED CAP</td> <td>2.000</td> <td>PC</td> </tr> <tr> <td>RC1414A1</td> <td>D11.5-12.5 SINGLE EAR HOSE CLAMP</td> <td>1.000</td> <td>PC</td> </tr> <tr> <td>TB2821A0</td> <td>EPDM 6X10 L=40MM PIPE</td> <td>4.000</td> <td>PC</td> </tr> </tbody> </table>	Code	Description	Qty	UOM	0H2202A1	ONE WASHING WITH STEAM VALVE SUPPORT	1.000	PC	EL1440A0	WATER SELF CLEANING VALVE	1.000	PC	GN1526A0	INT. D.=6.9 TH=1.8 O-RIN	3.000	PC	RC1019A0	D=10 ELASTIC CLAMP	12.000	PC	RC1242A0	D=10 CLOSED CAP	2.000	PC	RC1414A1	D11.5-12.5 SINGLE EAR HOSE CLAMP	1.000	PC	TB2821A0	EPDM 6X10 L=40MM PIPE	4.000	PC												
Code	Description	Qty	UOM																																														
0H2202A1	ONE WASHING WITH STEAM VALVE SUPPORT	1.000	PC																																														
EL1440A0	WATER SELF CLEANING VALVE	1.000	PC																																														
GN1526A0	INT. D.=6.9 TH=1.8 O-RIN	3.000	PC																																														
RC1019A0	D=10 ELASTIC CLAMP	12.000	PC																																														
RC1242A0	D=10 CLOSED CAP	2.000	PC																																														
RC1414A1	D11.5-12.5 SINGLE EAR HOSE CLAMP	1.000	PC																																														
TB2821A0	EPDM 6X10 L=40MM PIPE	4.000	PC																																														



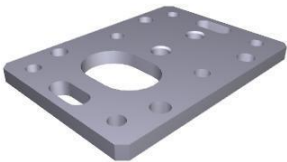



COMPONENT			SPARE PART																																																																		
Code	Description	Image	Code	Description	Kit components																																																																
VL1166A	BB6-AR6 L FITTING		KVL1182A	ONE 1ROT CLEANING SYSTEM KIT (0311 EXC.)	<table border="1"> <thead> <tr> <th>Code</th> <th>Description</th> <th>Qty</th> <th>UOM</th> </tr> </thead> <tbody> <tr> <td>TB3004A0</td> <td>TB2820A L=550mm EPDM BLACK PIPE</td> <td>1.000</td> <td>PC</td> </tr> <tr> <td>TB3009B0</td> <td>TB3132A-ONE OVEN WASHING INLET</td> <td>1.000</td> <td>PC</td> </tr> <tr> <td>TB3225B0</td> <td>TB2820A-TAN K-WASHYNG SYS CONNECTION</td> <td>1.000</td> <td>PC</td> </tr> <tr> <td>TB3614A0</td> <td>TB3614A0</td> <td>1.000</td> <td>PC</td> </tr> <tr> <td>VI1220A1</td> <td>4,2x12 TCB SELF-TAPPIN G SCREW</td> <td>2.000</td> <td>PC</td> </tr> <tr> <td>VL1019A0</td> <td>VIBRATION DETERGENT PUMP</td> <td>1.000</td> <td>PC</td> </tr> <tr> <td>VL1047A1</td> <td>D6 PIPE HOLDER - D8 J.G. TERMINAL</td> <td>1.000</td> <td>PC</td> </tr> <tr> <td>VL1054B0</td> <td>ONE WASHING SYS INLET DISTRIBUTOR</td> <td>1.000</td> <td>PC</td> </tr> <tr> <td>VL1102A1</td> <td>DETERGENT LINE FILTER + BARBED VNR 6 MM</td> <td>1.000</td> <td>PC</td> </tr> <tr> <td>VL1128A1</td> <td>D6 BARBED CHECK VALVE</td> <td>1.000</td> <td>PC</td> </tr> <tr> <td>VL1166A0</td> <td>BB6-AR6 L FITTING</td> <td>1.000</td> <td>PC</td> </tr> <tr> <td>VL1174C0</td> <td>D1.2 MM CALIBRATED NOZZLE</td> <td>1.000</td> <td>PC</td> </tr> <tr> <td>VL1191A0</td> <td>ONE WASHING DISTRIBUTOR OUTLETS KIT</td> <td>1.000</td> <td>PC</td> </tr> <tr> <td>VL1214A0</td> <td>BAYONET - 6mm BARBED NRV VALVE</td> <td>1.000</td> <td>PC</td> </tr> <tr> <td>VM2172A0</td> <td>LOCKING CLIP FOR PUMP WITH CIRCUIT</td> <td>2.000</td> <td>PC</td> </tr> </tbody> </table>	Code	Description	Qty	UOM	TB3004A0	TB2820A L=550mm EPDM BLACK PIPE	1.000	PC	TB3009B0	TB3132A-ONE OVEN WASHING INLET	1.000	PC	TB3225B0	TB2820A-TAN K-WASHYNG SYS CONNECTION	1.000	PC	TB3614A0	TB3614A0	1.000	PC	VI1220A1	4,2x12 TCB SELF-TAPPIN G SCREW	2.000	PC	VL1019A0	VIBRATION DETERGENT PUMP	1.000	PC	VL1047A1	D6 PIPE HOLDER - D8 J.G. TERMINAL	1.000	PC	VL1054B0	ONE WASHING SYS INLET DISTRIBUTOR	1.000	PC	VL1102A1	DETERGENT LINE FILTER + BARBED VNR 6 MM	1.000	PC	VL1128A1	D6 BARBED CHECK VALVE	1.000	PC	VL1166A0	BB6-AR6 L FITTING	1.000	PC	VL1174C0	D1.2 MM CALIBRATED NOZZLE	1.000	PC	VL1191A0	ONE WASHING DISTRIBUTOR OUTLETS KIT	1.000	PC	VL1214A0	BAYONET - 6mm BARBED NRV VALVE	1.000	PC	VM2172A0	LOCKING CLIP FOR PUMP WITH CIRCUIT	2.000	PC
Code	Description	Qty	UOM																																																																		
TB3004A0	TB2820A L=550mm EPDM BLACK PIPE	1.000	PC																																																																		
TB3009B0	TB3132A-ONE OVEN WASHING INLET	1.000	PC																																																																		
TB3225B0	TB2820A-TAN K-WASHYNG SYS CONNECTION	1.000	PC																																																																		
TB3614A0	TB3614A0	1.000	PC																																																																		
VI1220A1	4,2x12 TCB SELF-TAPPIN G SCREW	2.000	PC																																																																		
VL1019A0	VIBRATION DETERGENT PUMP	1.000	PC																																																																		
VL1047A1	D6 PIPE HOLDER - D8 J.G. TERMINAL	1.000	PC																																																																		
VL1054B0	ONE WASHING SYS INLET DISTRIBUTOR	1.000	PC																																																																		
VL1102A1	DETERGENT LINE FILTER + BARBED VNR 6 MM	1.000	PC																																																																		
VL1128A1	D6 BARBED CHECK VALVE	1.000	PC																																																																		
VL1166A0	BB6-AR6 L FITTING	1.000	PC																																																																		
VL1174C0	D1.2 MM CALIBRATED NOZZLE	1.000	PC																																																																		
VL1191A0	ONE WASHING DISTRIBUTOR OUTLETS KIT	1.000	PC																																																																		
VL1214A0	BAYONET - 6mm BARBED NRV VALVE	1.000	PC																																																																		
VM2172A0	LOCKING CLIP FOR PUMP WITH CIRCUIT	2.000	PC																																																																		
			KVL1166A	BB6-AR6 L FITTING 5 PCS KIT	<table border="1"> <thead> <tr> <th>Code</th> <th>Description</th> <th>Qty</th> <th>UOM</th> </tr> </thead> <tbody> <tr> <td>VL1166A0</td> <td>BB6-AR6 L FITTING</td> <td>5.000</td> <td>PC</td> </tr> </tbody> </table>	Code	Description	Qty	UOM	VL1166A0	BB6-AR6 L FITTING	5.000	PC																																																								
Code	Description	Qty	UOM																																																																		
VL1166A0	BB6-AR6 L FITTING	5.000	PC																																																																		





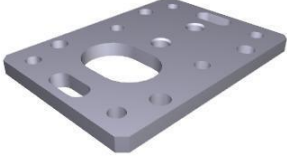

COMPONENT			SPARE PART																										
Code	Description	Image	Code	Description	Kit components																								
VM2172A	LOCKING CLIP FOR PUMP WITH CIRCUIT		VM2172A0	LOCKING CLIP FOR PUMP WITH CIRCUIT																									
0H2561A	6 S. DOOR COUNTERBRACKET		0H2561A0	6 S. DOOR COUNTERBRACKET																									
VI1995A	M5x25 ST. STEEL SCREW		VI1995A0	M5x25 ST. STEEL SCREW																									
VM1240A	NYLON SUPPORT CAP		KVM1240A	4 PCS COUNTER BRACKET SUPPORT CAP KIT	<table border="1"> <thead> <tr> <th>Code</th> <th>Description</th> <th>Qty</th> <th>UOM</th> </tr> </thead> <tbody> <tr> <td>VM1240A0</td> <td>NYLON SUPPORT CAP</td> <td>4.000</td> <td>PC</td> </tr> </tbody> </table>	Code	Description	Qty	UOM	VM1240A0	NYLON SUPPORT CAP	4.000	PC																
Code	Description	Qty	UOM																										
VM1240A0	NYLON SUPPORT CAP	4.000	PC																										
VM2273A	MM DOOR LEFT LOWER BRACKET		KVM2273A	MIND.Maps DOOR LOWER LEFT BRACKET KIT	<table border="1"> <thead> <tr> <th>Code</th> <th>Description</th> <th>Qty</th> <th>UOM</th> </tr> </thead> <tbody> <tr> <td>0H7330A0</td> <td>DOOR LOWER BRACKET WASHER</td> <td>2.000</td> <td>PC</td> </tr> <tr> <td>VI1995A0</td> <td>M5x25 ST. STEEL SCREW</td> <td>4.000</td> <td>PC</td> </tr> <tr> <td>VM2273A1</td> <td>MM DOOR LEFT LOWER BRACKET</td> <td>1.000</td> <td>PC</td> </tr> <tr> <td>VM2352A0</td> <td>MM LOWER DOOR BRACKET LEFT SCREW COVER</td> <td>1.000</td> <td>PC</td> </tr> <tr> <td>VM2353A0</td> <td>MM LOWER DOOR BRACKET RIGHT SCREW COVER</td> <td>1.000</td> <td>PC</td> </tr> </tbody> </table>	Code	Description	Qty	UOM	0H7330A0	DOOR LOWER BRACKET WASHER	2.000	PC	VI1995A0	M5x25 ST. STEEL SCREW	4.000	PC	VM2273A1	MM DOOR LEFT LOWER BRACKET	1.000	PC	VM2352A0	MM LOWER DOOR BRACKET LEFT SCREW COVER	1.000	PC	VM2353A0	MM LOWER DOOR BRACKET RIGHT SCREW COVER	1.000	PC
Code	Description	Qty	UOM																										
0H7330A0	DOOR LOWER BRACKET WASHER	2.000	PC																										
VI1995A0	M5x25 ST. STEEL SCREW	4.000	PC																										
VM2273A1	MM DOOR LEFT LOWER BRACKET	1.000	PC																										
VM2352A0	MM LOWER DOOR BRACKET LEFT SCREW COVER	1.000	PC																										
VM2353A0	MM LOWER DOOR BRACKET RIGHT SCREW COVER	1.000	PC																										



COMPONENT			SPARE PART										
Code	Description	Image	Code	Description	Kit components								
VM2352A	MM LOWER DOOR BRACKET LEFT SCREW COVERI		VM2352A0	MM LOWER DOOR BRACKET LEFT SCREW COVERI									
VM2353A	MM LOWER DOOR BRACKET RIGHT SCREW COVERI		VM2353A0	MM LOWER DOOR BRACKET RIGHT SCREW COVERI									
0H2561A	6 S. DOOR COUNTERBRACKET		0H2561A0	6 S. DOOR COUNTERBRACKET									
VI1995A	M5x25 ST.STEEL SCREW		VI1995A0	M5x25 ST.STEEL SCREW									
VM1240A	NYLON SUPPORT CAP		KVM1240A	4 PCS COUNTER BRACKET SUPPORT CAP KIT	<table border="1"> <thead> <tr> <th>Code</th> <th>Description</th> <th>Qty</th> <th>UOM</th> </tr> </thead> <tbody> <tr> <td>VM1240A0</td> <td>NYLON SUPPORT CAP</td> <td>4.000</td> <td>PC</td> </tr> </tbody> </table>	Code	Description	Qty	UOM	VM1240A0	NYLON SUPPORT CAP	4.000	PC
Code	Description	Qty	UOM										
VM1240A0	NYLON SUPPORT CAP	4.000	PC										

COMPONENT			SPARE PART																														
Code	Description	Image	Code	Description	Kit components																												
VM2271A	MM DOOR LEFT UPPER BRACKET		KVM2271A	MIND.MAPS UPPER LEFT DOOR BRACKET KIT	<table border="1"> <thead> <tr> <th>Code</th> <th>Description</th> <th>Qty</th> <th>UOM</th> </tr> </thead> <tbody> <tr> <td>VI1220A1</td> <td>4,2x12 TCB SELF-TAPPIN G SCREW</td> <td>2.000</td> <td>PC</td> </tr> <tr> <td>VI1995A0</td> <td>M5x25 ST.STEEL SCREW</td> <td>4.000</td> <td>PC</td> </tr> <tr> <td>VI1997A0</td> <td>5x10X1 FLAT WASHER</td> <td>4.000</td> <td>PC</td> </tr> <tr> <td>VM2271A0</td> <td>MM DOOR LEFT UPPER BRACKET</td> <td>1.000</td> <td>PC</td> </tr> <tr> <td>VM2298A0</td> <td>DOOR BRACKET UPPER COVER</td> <td>1.000</td> <td>PC</td> </tr> </tbody> </table>	Code	Description	Qty	UOM	VI1220A1	4,2x12 TCB SELF-TAPPIN G SCREW	2.000	PC	VI1995A0	M5x25 ST.STEEL SCREW	4.000	PC	VI1997A0	5x10X1 FLAT WASHER	4.000	PC	VM2271A0	MM DOOR LEFT UPPER BRACKET	1.000	PC	VM2298A0	DOOR BRACKET UPPER COVER	1.000	PC				
Code	Description	Qty	UOM																														
VI1220A1	4,2x12 TCB SELF-TAPPIN G SCREW	2.000	PC																														
VI1995A0	M5x25 ST.STEEL SCREW	4.000	PC																														
VI1997A0	5x10X1 FLAT WASHER	4.000	PC																														
VM2271A0	MM DOOR LEFT UPPER BRACKET	1.000	PC																														
VM2298A0	DOOR BRACKET UPPER COVER	1.000	PC																														
VM2298A	DOOR BRACKET UPPER COVER		KVM2298A	MIND.Maps DOOR UPPER BRACKET COVER KIT	<table border="1"> <thead> <tr> <th>Code</th> <th>Description</th> <th>Qty</th> <th>UOM</th> </tr> </thead> <tbody> <tr> <td>VI1220A1</td> <td>4,2x12 TCB SELF-TAPPIN G SCREW</td> <td>2.000</td> <td>PC</td> </tr> <tr> <td>VM2298A0</td> <td>DOOR BRACKET UPPER COVER</td> <td>1.000</td> <td>PC</td> </tr> </tbody> </table>	Code	Description	Qty	UOM	VI1220A1	4,2x12 TCB SELF-TAPPIN G SCREW	2.000	PC	VM2298A0	DOOR BRACKET UPPER COVER	1.000	PC																
Code	Description	Qty	UOM																														
VI1220A1	4,2x12 TCB SELF-TAPPIN G SCREW	2.000	PC																														
VM2298A0	DOOR BRACKET UPPER COVER	1.000	PC																														
0H2561A	6 S. DOOR COUNTERBRACKET		0H2561A0	6 S. DOOR COUNTERBRACKET																													
VE1020B	MAGNET DOOR MICROSWITCH		KVE1020B	MICROSWITCH KIT	<table border="1"> <thead> <tr> <th>Code</th> <th>Description</th> <th>Qty</th> <th>UOM</th> </tr> </thead> <tbody> <tr> <td>CE1030A0</td> <td>FEMALE FASTON COVER 6.3X0.8 0.5-1mmq</td> <td>2.000</td> <td>PC</td> </tr> <tr> <td>CE1660A0</td> <td>6,3x0,8 FEMALE FASTON COVE</td> <td>2.000</td> <td>PC</td> </tr> <tr> <td>CE1730A0</td> <td>PVC CABLE NP 2 X AWG22 STYLE 2095</td> <td>0.150</td> <td>M</td> </tr> <tr> <td>CE1740A0</td> <td>MINIFIT MALE END FITTING</td> <td>2.000</td> <td>PC</td> </tr> <tr> <td>CE1745A0</td> <td>2 WAYS FEMALE MINIFIT CONNECTOR</td> <td>1.000</td> <td>PC</td> </tr> <tr> <td>VE1020B0</td> <td>MAGNET DOOR MICROSWITC</td> <td>1.000</td> <td>PC</td> </tr> </tbody> </table>	Code	Description	Qty	UOM	CE1030A0	FEMALE FASTON COVER 6.3X0.8 0.5-1mmq	2.000	PC	CE1660A0	6,3x0,8 FEMALE FASTON COVE	2.000	PC	CE1730A0	PVC CABLE NP 2 X AWG22 STYLE 2095	0.150	M	CE1740A0	MINIFIT MALE END FITTING	2.000	PC	CE1745A0	2 WAYS FEMALE MINIFIT CONNECTOR	1.000	PC	VE1020B0	MAGNET DOOR MICROSWITC	1.000	PC
Code	Description	Qty	UOM																														
CE1030A0	FEMALE FASTON COVER 6.3X0.8 0.5-1mmq	2.000	PC																														
CE1660A0	6,3x0,8 FEMALE FASTON COVE	2.000	PC																														
CE1730A0	PVC CABLE NP 2 X AWG22 STYLE 2095	0.150	M																														
CE1740A0	MINIFIT MALE END FITTING	2.000	PC																														
CE1745A0	2 WAYS FEMALE MINIFIT CONNECTOR	1.000	PC																														
VE1020B0	MAGNET DOOR MICROSWITC	1.000	PC																														

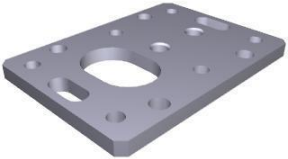



COMPONENT			SPARE PART														
Code	Description	Image	Code	Description	Kit components												
VE1020B	MAGNET DOOR MICROSWITCH		KVE1020B	MICROSWITCH KIT	<table border="1"> <thead> <tr> <th>Code</th> <th>Description</th> <th>Qty</th> <th>UOM</th> </tr> </thead> <tbody> <tr> <td>VE1030A1</td> <td>MAGNET FOR DOOR MICROSWITC H D=22.9mm</td> <td>1.000</td> <td>PC</td> </tr> <tr> <td>V1192A0</td> <td></td> <td>1.000</td> <td>PC</td> </tr> </tbody> </table>	Code	Description	Qty	UOM	VE1030A1	MAGNET FOR DOOR MICROSWITC H D=22.9mm	1.000	PC	V1192A0		1.000	PC
Code	Description	Qty	UOM														
VE1030A1	MAGNET FOR DOOR MICROSWITC H D=22.9mm	1.000	PC														
V1192A0		1.000	PC														
VM1240A	NYLON SUPPORT CAP		KVM1240A	4 PCS COUNTER BRACKET SUPPORT CAP KIT	<table border="1"> <thead> <tr> <th>Code</th> <th>Description</th> <th>Qty</th> <th>UOM</th> </tr> </thead> <tbody> <tr> <td>VM1240A0</td> <td>NYLON SUPPORT CAP</td> <td>4.000</td> <td>PC</td> </tr> </tbody> </table>	Code	Description	Qty	UOM	VM1240A0	NYLON SUPPORT CAP	4.000	PC				
Code	Description	Qty	UOM														
VM1240A0	NYLON SUPPORT CAP	4.000	PC														
VP1075A	PLUS/1/ZERO MICROSWITCH SUPPORT COVER		KVP1075A	-M MICROSWITCH SUPPORT PLATE KI	<table border="1"> <thead> <tr> <th>Code</th> <th>Description</th> <th>Qty</th> <th>UOM</th> </tr> </thead> <tbody> <tr> <td>VP1075A0</td> <td>PLUS/1/ZERO MICROSWITC H SUPPORT COVER</td> <td>1.000</td> <td>PC</td> </tr> </tbody> </table>	Code	Description	Qty	UOM	VP1075A0	PLUS/1/ZERO MICROSWITC H SUPPORT COVER	1.000	PC				
Code	Description	Qty	UOM														
VP1075A0	PLUS/1/ZERO MICROSWITC H SUPPORT COVER	1.000	PC														
0H2561A	6 S. DOOR COUNTERBRACKET		0H2561A0	6 S. DOOR COUNTERBRACKET													
VM1240A	NYLON SUPPORT CAP		KVM1240A	4 PCS COUNTER BRACKET SUPPORT CAP KIT	<table border="1"> <thead> <tr> <th>Code</th> <th>Description</th> <th>Qty</th> <th>UOM</th> </tr> </thead> <tbody> <tr> <td>VM1240A0</td> <td>NYLON SUPPORT CAP</td> <td>4.000</td> <td>PC</td> </tr> </tbody> </table>	Code	Description	Qty	UOM	VM1240A0	NYLON SUPPORT CAP	4.000	PC				
Code	Description	Qty	UOM														
VM1240A0	NYLON SUPPORT CAP	4.000	PC														





COMPONENT			SPARE PART																		
Code	Description	Image	Code	Description	Kit components																
VM2310A	UPPER DOOR BRACKET HOLES COVER		KVM2310A	UPPER BRACKET HOLE COVER KIT	<table border="1"> <thead> <tr> <th>Code</th> <th>Description</th> <th>Qty</th> <th>UOM</th> </tr> </thead> <tbody> <tr> <td>VM2310A0</td> <td>UPPER DOOR BRACKET HOLES COVER</td> <td>1.000</td> <td>PC</td> </tr> </tbody> </table>	Code	Description	Qty	UOM	VM2310A0	UPPER DOOR BRACKET HOLES COVER	1.000	PC								
Code	Description	Qty	UOM																		
VM2310A0	UPPER DOOR BRACKET HOLES COVER	1.000	PC																		
0H1019A	BRACKET FOR CHEFTOP H100 FEE		K0H1019A	CT REINF. PLATE FOR H100 FEET	<table border="1"> <thead> <tr> <th>Code</th> <th>Description</th> <th>Qty</th> <th>UOM</th> </tr> </thead> <tbody> <tr> <td>0H1019A2</td> <td>BRACKET FOR CHEFTOP H100 FEET</td> <td>1.000</td> <td>PC</td> </tr> <tr> <td>V11739A0</td> <td>ZINC THREAD INSERT M10 FTT/E STP</td> <td>2.000</td> <td>PC</td> </tr> </tbody> </table>	Code	Description	Qty	UOM	0H1019A2	BRACKET FOR CHEFTOP H100 FEET	1.000	PC	V11739A0	ZINC THREAD INSERT M10 FTT/E STP	2.000	PC				
Code	Description	Qty	UOM																		
0H1019A2	BRACKET FOR CHEFTOP H100 FEET	1.000	PC																		
V11739A0	ZINC THREAD INSERT M10 FTT/E STP	2.000	PC																		
PD1074A	H=100 SQUARE FOO		KPD1074A	Mind.Maps H100 FOOT KIT	<table border="1"> <thead> <tr> <th>Code</th> <th>Description</th> <th>Qty</th> <th>UOM</th> </tr> </thead> <tbody> <tr> <td>PD1074A0</td> <td>H=100 SQUARE FOO</td> <td>1.000</td> <td>PC</td> </tr> <tr> <td>PD1075A1</td> <td>PD1074 FOOT LOCKING BRACKET</td> <td>1.000</td> <td>PC</td> </tr> <tr> <td>V11220A1</td> <td>4,2x12 TCB SELF-TAPPIN G SCREW</td> <td>5.000</td> <td>PC</td> </tr> </tbody> </table>	Code	Description	Qty	UOM	PD1074A0	H=100 SQUARE FOO	1.000	PC	PD1075A1	PD1074 FOOT LOCKING BRACKET	1.000	PC	V11220A1	4,2x12 TCB SELF-TAPPIN G SCREW	5.000	PC
Code	Description	Qty	UOM																		
PD1074A0	H=100 SQUARE FOO	1.000	PC																		
PD1075A1	PD1074 FOOT LOCKING BRACKET	1.000	PC																		
V11220A1	4,2x12 TCB SELF-TAPPIN G SCREW	5.000	PC																		
PD1075A	PD1074 FOOT LOCKING BRACKET		KPD1075A	OVEN FOOT STOPPING BRACKET 4 PCS KIT	<table border="1"> <thead> <tr> <th>Code</th> <th>Description</th> <th>Qty</th> <th>UOM</th> </tr> </thead> <tbody> <tr> <td>PD1075A1</td> <td>PD1074 FOOT LOCKING BRACKET</td> <td>4.000</td> <td>PC</td> </tr> <tr> <td>V11950A0</td> <td>ST. STEEL 4,2X13 TCB SELF-DRILLIN G SCREW</td> <td>8.000</td> <td>PC</td> </tr> </tbody> </table>	Code	Description	Qty	UOM	PD1075A1	PD1074 FOOT LOCKING BRACKET	4.000	PC	V11950A0	ST. STEEL 4,2X13 TCB SELF-DRILLIN G SCREW	8.000	PC				
Code	Description	Qty	UOM																		
PD1075A1	PD1074 FOOT LOCKING BRACKET	4.000	PC																		
V11950A0	ST. STEEL 4,2X13 TCB SELF-DRILLIN G SCREW	8.000	PC																		
PD1074A	H=100 SQUARE FOO		KPD1074A	Mind.Maps H100 FOOT KIT	<table border="1"> <thead> <tr> <th>Code</th> <th>Description</th> <th>Qty</th> <th>UOM</th> </tr> </thead> <tbody> <tr> <td>PD1074A0</td> <td>H=100 SQUARE FOO</td> <td>1.000</td> <td>PC</td> </tr> <tr> <td>PD1075A1</td> <td>PD1074 FOOT LOCKING BRACKET</td> <td>1.000</td> <td>PC</td> </tr> <tr> <td>V11220A1</td> <td>4,2x12 TCB SELF-TAPPIN G SCREW</td> <td>5.000</td> <td>PC</td> </tr> </tbody> </table>	Code	Description	Qty	UOM	PD1074A0	H=100 SQUARE FOO	1.000	PC	PD1075A1	PD1074 FOOT LOCKING BRACKET	1.000	PC	V11220A1	4,2x12 TCB SELF-TAPPIN G SCREW	5.000	PC
Code	Description	Qty	UOM																		
PD1074A0	H=100 SQUARE FOO	1.000	PC																		
PD1075A1	PD1074 FOOT LOCKING BRACKET	1.000	PC																		
V11220A1	4,2x12 TCB SELF-TAPPIN G SCREW	5.000	PC																		

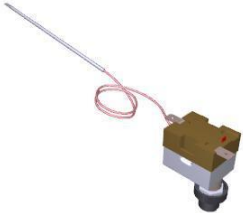

COMPONENT			SPARE PART														
Code	Description	Image	Code	Description	Kit components												
PD1075A	PD1074 FOOT LOCKING BRACKET		KPD1075A	OVEN FOOT STOPPING BRACKET 4 PCS KIT	<table border="1"> <thead> <tr> <th>Code</th> <th>Description</th> <th>Qty</th> <th>UOM</th> </tr> </thead> <tbody> <tr> <td>PD1075A1</td> <td>PD1074 FOOT LOCKING BRACKET</td> <td>4.000</td> <td>PC</td> </tr> <tr> <td>VI1950A0</td> <td>ST. STEEL 4.2X13 TCB SELF-DRILLIN G SCREW</td> <td>8.000</td> <td>PC</td> </tr> </tbody> </table>	Code	Description	Qty	UOM	PD1075A1	PD1074 FOOT LOCKING BRACKET	4.000	PC	VI1950A0	ST. STEEL 4.2X13 TCB SELF-DRILLIN G SCREW	8.000	PC
Code	Description	Qty	UOM														
PD1075A1	PD1074 FOOT LOCKING BRACKET	4.000	PC														
VI1950A0	ST. STEEL 4.2X13 TCB SELF-DRILLIN G SCREW	8.000	PC														
ASM3121A	General overview		ASM3121A0	General overview													
0H7810A	SUPPORT PLATE DOUBLE LIGHTER		0H7810A0	SUPPORT PLATE DOUBLE LIGHTER													
VE1115A	20 A 230V 4 POLES MINICONTACTOR		KVE1115A	20A 230V 4 POLES MINICONTACTOR KI	<table border="1"> <thead> <tr> <th>Code</th> <th>Description</th> <th>Qty</th> <th>UOM</th> </tr> </thead> <tbody> <tr> <td>VE1115A0</td> <td>20 A 230V 4 POLES MINICONTACT OR</td> <td>1.000</td> <td>PC</td> </tr> <tr> <td>VM1075A1</td> <td>PLASTIC CLIP TO FIX CONTACTORS</td> <td>4.000</td> <td>PC</td> </tr> </tbody> </table>	Code	Description	Qty	UOM	VE1115A0	20 A 230V 4 POLES MINICONTACT OR	1.000	PC	VM1075A1	PLASTIC CLIP TO FIX CONTACTORS	4.000	PC
Code	Description	Qty	UOM														
VE1115A0	20 A 230V 4 POLES MINICONTACT OR	1.000	PC														
VM1075A1	PLASTIC CLIP TO FIX CONTACTORS	4.000	PC														
VM1056A	SMALL CONTACTOR BRACKET VE1115A		VM1056A0	SMALL CONTACTOR BRACKET VE1115A													

COMPONENT			SPARE PART																																																														
Code	Description	Image	Code	Description	Kit components																																																												
VE1625A	5E- MM SERIES FIDA GAS LIGHTER		KVE0009B	EUROPE VERSION GAS IGNITER KIT	<table border="1"> <thead> <tr> <th>Code</th> <th>Description</th> <th>Qty</th> <th>UOM</th> </tr> </thead> <tbody> <tr> <td>0H5126A0</td> <td>IGNITER FIXING OMEG</td> <td>1.000</td> <td>PC</td> </tr> <tr> <td>0H6825A0</td> <td>METAL CLAMP</td> <td>1.000</td> <td>PC</td> </tr> <tr> <td>CE1390A0</td> <td>YELLOW CABLE UNIP RUBB.SIL. Ø 0,75 MMQ</td> <td>0.260</td> <td>M</td> </tr> <tr> <td>CE1395A0</td> <td>6,3 X 0,8 iMALE FASTO</td> <td>4.000</td> <td>PC</td> </tr> <tr> <td>CE1661A0</td> <td>MALE FASTON COVER 6,3x0,8</td> <td>4.000</td> <td>PC</td> </tr> <tr> <td>CE1777A1</td> <td>HV START UP CABLE L=700 WITH SILICON CAP</td> <td>2.000</td> <td>PC</td> </tr> <tr> <td>CE1782A0</td> <td>HV L=300 BRIDGE FIDA CABLE</td> <td>1.000</td> <td>PC</td> </tr> <tr> <td>CE1792A0</td> <td>FLAME DETECTOR CANDLE CABL</td> <td>1.000</td> <td>PC</td> </tr> <tr> <td>CE1811A1</td> <td>LIGHTER CONNECTING CABLE PLUG 90°</td> <td>1.000</td> <td>PC</td> </tr> <tr> <td>GN1328A1</td> <td>BACK BLACK ADESIVE GASKET 8X3</td> <td>0.500</td> <td>M</td> </tr> <tr> <td>VE1625A0</td> <td>5E- MM SERIES FIDA GAS LIGHTER</td> <td>1.000</td> <td>PC</td> </tr> <tr> <td>VH1220A1</td> <td>4,2x12 TCB SELF-TAPPIN G SCREW</td> <td>2.000</td> <td>PC</td> </tr> <tr> <td>VH1950A0</td> <td>ST. STEEL 4,2X13 TCB SELF-DRILLIN G SCREW</td> <td>1.000</td> <td>PC</td> </tr> <tr> <td>VM1255A1</td> <td>THREAD-COV ERING CAP MARUTEX</td> <td>1.000</td> <td>PC</td> </tr> </tbody> </table>	Code	Description	Qty	UOM	0H5126A0	IGNITER FIXING OMEG	1.000	PC	0H6825A0	METAL CLAMP	1.000	PC	CE1390A0	YELLOW CABLE UNIP RUBB.SIL. Ø 0,75 MMQ	0.260	M	CE1395A0	6,3 X 0,8 iMALE FASTO	4.000	PC	CE1661A0	MALE FASTON COVER 6,3x0,8	4.000	PC	CE1777A1	HV START UP CABLE L=700 WITH SILICON CAP	2.000	PC	CE1782A0	HV L=300 BRIDGE FIDA CABLE	1.000	PC	CE1792A0	FLAME DETECTOR CANDLE CABL	1.000	PC	CE1811A1	LIGHTER CONNECTING CABLE PLUG 90°	1.000	PC	GN1328A1	BACK BLACK ADESIVE GASKET 8X3	0.500	M	VE1625A0	5E- MM SERIES FIDA GAS LIGHTER	1.000	PC	VH1220A1	4,2x12 TCB SELF-TAPPIN G SCREW	2.000	PC	VH1950A0	ST. STEEL 4,2X13 TCB SELF-DRILLIN G SCREW	1.000	PC	VM1255A1	THREAD-COV ERING CAP MARUTEX	1.000	PC
Code	Description	Qty	UOM																																																														
0H5126A0	IGNITER FIXING OMEG	1.000	PC																																																														
0H6825A0	METAL CLAMP	1.000	PC																																																														
CE1390A0	YELLOW CABLE UNIP RUBB.SIL. Ø 0,75 MMQ	0.260	M																																																														
CE1395A0	6,3 X 0,8 iMALE FASTO	4.000	PC																																																														
CE1661A0	MALE FASTON COVER 6,3x0,8	4.000	PC																																																														
CE1777A1	HV START UP CABLE L=700 WITH SILICON CAP	2.000	PC																																																														
CE1782A0	HV L=300 BRIDGE FIDA CABLE	1.000	PC																																																														
CE1792A0	FLAME DETECTOR CANDLE CABL	1.000	PC																																																														
CE1811A1	LIGHTER CONNECTING CABLE PLUG 90°	1.000	PC																																																														
GN1328A1	BACK BLACK ADESIVE GASKET 8X3	0.500	M																																																														
VE1625A0	5E- MM SERIES FIDA GAS LIGHTER	1.000	PC																																																														
VH1220A1	4,2x12 TCB SELF-TAPPIN G SCREW	2.000	PC																																																														
VH1950A0	ST. STEEL 4,2X13 TCB SELF-DRILLIN G SCREW	1.000	PC																																																														
VM1255A1	THREAD-COV ERING CAP MARUTEX	1.000	PC																																																														
VM1066A	SADDLE CLIP FOR CABLES PASSING		VM1066A0	SADDLE CLIP FOR CABLES PASSING																																																													

COMPONENT			SPARE PART																										
Code	Description	Image	Code	Description	Kit components																								
GN1579A	GAS CHIMENEY'S GASKET (tt)		KG1579A	2 PCS GAS CHIMENEY GASKET KIT	<table border="1"> <thead> <tr> <th>Code</th> <th>Description</th> <th>Qty</th> <th>UOM</th> </tr> </thead> <tbody> <tr> <td>GN1579A0</td> <td>GAS CHIMENEY'S GASKET (tt)</td> <td>2.000</td> <td>PC</td> </tr> </tbody> </table>	Code	Description	Qty	UOM	GN1579A0	GAS CHIMENEY'S GASKET (tt)	2.000	PC																
Code	Description	Qty	UOM																										
GN1579A0	GAS CHIMENEY'S GASKET (tt)	2.000	PC																										
TR1136A	318°C -0/+24 1 POLE SAFETY THERMOSTAT		KTR1136A	318°C -0/+24 SAFETY THERMOSTAT KIT	<table border="1"> <thead> <tr> <th>Code</th> <th>Description</th> <th>Qty</th> <th>UOM</th> </tr> </thead> <tbody> <tr> <td>0H8120A0</td> <td>XEVL BULB PASS-THROU GH COVER</td> <td>1.000</td> <td>PC</td> </tr> <tr> <td>GN1531A0</td> <td>THERMOSTAT BULB INLET SEALING</td> <td>1.000</td> <td>PC</td> </tr> <tr> <td>SL1045A0</td> <td>S57 BLACK SILICONE - 80ml CARTRIDGE</td> <td>1.000</td> <td>PC</td> </tr> <tr> <td>TR1136A0</td> <td>318°C -0/+24 1 POLE SAFETY THERMOSTAT</td> <td>1.000</td> <td>PC</td> </tr> <tr> <td>V11220A1</td> <td>4,2x12 TCB SELF-TAPPIN G SCREW</td> <td>3.000</td> <td>PC</td> </tr> </tbody> </table>	Code	Description	Qty	UOM	0H8120A0	XEVL BULB PASS-THROU GH COVER	1.000	PC	GN1531A0	THERMOSTAT BULB INLET SEALING	1.000	PC	SL1045A0	S57 BLACK SILICONE - 80ml CARTRIDGE	1.000	PC	TR1136A0	318°C -0/+24 1 POLE SAFETY THERMOSTAT	1.000	PC	V11220A1	4,2x12 TCB SELF-TAPPIN G SCREW	3.000	PC
Code	Description	Qty	UOM																										
0H8120A0	XEVL BULB PASS-THROU GH COVER	1.000	PC																										
GN1531A0	THERMOSTAT BULB INLET SEALING	1.000	PC																										
SL1045A0	S57 BLACK SILICONE - 80ml CARTRIDGE	1.000	PC																										
TR1136A0	318°C -0/+24 1 POLE SAFETY THERMOSTAT	1.000	PC																										
V11220A1	4,2x12 TCB SELF-TAPPIN G SCREW	3.000	PC																										
VM1991A	CHEFTOP E SERIES DRIP TRAY		KVM1991A	E SERIES CHEFTOP DRIP TRAY	<table border="1"> <thead> <tr> <th>Code</th> <th>Description</th> <th>Qty</th> <th>UOM</th> </tr> </thead> <tbody> <tr> <td>VM1220A0</td> <td>CLIP TO FIX DRIP TRAY C.T</td> <td>4.000</td> <td>PC</td> </tr> <tr> <td>VM1991A0</td> <td>CHEFTOP E SERIES DRIP TRAY</td> <td>1.000</td> <td>PC</td> </tr> <tr> <td>VM2074A1</td> <td>DRAWER SUPPORT SCREW WITH CLIP</td> <td>4.000</td> <td>PC</td> </tr> </tbody> </table>	Code	Description	Qty	UOM	VM1220A0	CLIP TO FIX DRIP TRAY C.T	4.000	PC	VM1991A0	CHEFTOP E SERIES DRIP TRAY	1.000	PC	VM2074A1	DRAWER SUPPORT SCREW WITH CLIP	4.000	PC								
Code	Description	Qty	UOM																										
VM1220A0	CLIP TO FIX DRIP TRAY C.T	4.000	PC																										
VM1991A0	CHEFTOP E SERIES DRIP TRAY	1.000	PC																										
VM2074A1	DRAWER SUPPORT SCREW WITH CLIP	4.000	PC																										
VM2035A	DRAIN PIPE SUPPORT		KVM2035A	DRAIN PIPE SUPPORT 2 PCS. KI	<table border="1"> <thead> <tr> <th>Code</th> <th>Description</th> <th>Qty</th> <th>UOM</th> </tr> </thead> <tbody> <tr> <td>VM2035A0</td> <td>DRAIN PIPE SUPPORT</td> <td>2.000</td> <td>PC</td> </tr> </tbody> </table>	Code	Description	Qty	UOM	VM2035A0	DRAIN PIPE SUPPORT	2.000	PC																
Code	Description	Qty	UOM																										
VM2035A0	DRAIN PIPE SUPPORT	2.000	PC																										



COMPONENT			SPARE PART																						
Code	Description	Image	Code	Description	Kit components																				
VM2061A	ACCESSORIES CABLES WALL PASSING		KVM1505A	THROUGH-WALL CONNECTION+DIAPHRAGM KIT	<table border="1"> <thead> <tr> <th>Code</th> <th>Description</th> <th>Qty</th> <th>UOM</th> </tr> </thead> <tbody> <tr> <td>VI1220A1</td> <td>4,2x12 TCB SELF-TAPPING G SCREW</td> <td>1.000</td> <td>PC</td> </tr> <tr> <td>VM1505A0</td> <td>WALL PASSING WITH DIAPHRAGM</td> <td>3.000</td> <td>PC</td> </tr> <tr> <td>VM2055A0</td> <td>UPPER WALL PASSING ACCESSORY CABLES</td> <td>1.000</td> <td>PC</td> </tr> <tr> <td>VM2056A0</td> <td>LOWER WALL PASSING ACCESSORY CABLES</td> <td>1.000</td> <td>PC</td> </tr> </tbody> </table>	Code	Description	Qty	UOM	VI1220A1	4,2x12 TCB SELF-TAPPING G SCREW	1.000	PC	VM1505A0	WALL PASSING WITH DIAPHRAGM	3.000	PC	VM2055A0	UPPER WALL PASSING ACCESSORY CABLES	1.000	PC	VM2056A0	LOWER WALL PASSING ACCESSORY CABLES	1.000	PC
Code	Description	Qty	UOM																						
VI1220A1	4,2x12 TCB SELF-TAPPING G SCREW	1.000	PC																						
VM1505A0	WALL PASSING WITH DIAPHRAGM	3.000	PC																						
VM2055A0	UPPER WALL PASSING ACCESSORY CABLES	1.000	PC																						
VM2056A0	LOWER WALL PASSING ACCESSORY CABLES	1.000	PC																						
VM2074A	DRAWER SUPPORT SCREW WITH CLIP		KVM1220A	CT/BT DRIP TRAY FIXING CLIPS 4PCS KIT	<table border="1"> <thead> <tr> <th>Code</th> <th>Description</th> <th>Qty</th> <th>UOM</th> </tr> </thead> <tbody> <tr> <td>VI1220A1</td> <td>4,2x12 TCB SELF-TAPPING G SCREW</td> <td>4.000</td> <td>PC</td> </tr> <tr> <td>VM1220A0</td> <td>CLIP TO FIX DRIP TRAY C.T</td> <td>4.000</td> <td>PC</td> </tr> <tr> <td>VM2074A1</td> <td>DRAWER SUPPORT SCREW WITH CLIP</td> <td>4.000</td> <td>PC</td> </tr> </tbody> </table>	Code	Description	Qty	UOM	VI1220A1	4,2x12 TCB SELF-TAPPING G SCREW	4.000	PC	VM1220A0	CLIP TO FIX DRIP TRAY C.T	4.000	PC	VM2074A1	DRAWER SUPPORT SCREW WITH CLIP	4.000	PC				
Code	Description	Qty	UOM																						
VI1220A1	4,2x12 TCB SELF-TAPPING G SCREW	4.000	PC																						
VM1220A0	CLIP TO FIX DRIP TRAY C.T	4.000	PC																						
VM2074A1	DRAWER SUPPORT SCREW WITH CLIP	4.000	PC																						
VM2249A	COOKING CHAMBER FRONT CORNER		KVM2249A	CHAMBER FRONT PROFILE CORNER KIT	<table border="1"> <thead> <tr> <th>Code</th> <th>Description</th> <th>Qty</th> <th>UOM</th> </tr> </thead> <tbody> <tr> <td>VM2249A0</td> <td>COOKING CHAMBER FRONT CORNER</td> <td>1.000</td> <td>PC</td> </tr> </tbody> </table>	Code	Description	Qty	UOM	VM2249A0	COOKING CHAMBER FRONT CORNER	1.000	PC												
Code	Description	Qty	UOM																						
VM2249A0	COOKING CHAMBER FRONT CORNER	1.000	PC																						
VM2308A	PREMIX COVER BOX		VM2308A0	PREMIX COVER BOX																					



COMPONENT			SPARE PART														
Code	Description	Image	Code	Description	Kit components												
VM2311A	SCREWS COVER		KVM2311A	SCREWS COVER PLATE KIT	<table border="1"> <thead> <tr> <th>Code</th> <th>Description</th> <th>Qty</th> <th>UOM</th> </tr> </thead> <tbody> <tr> <td>VM2311A0</td> <td>SCREWS COVER</td> <td>1.000</td> <td>PC</td> </tr> </tbody> </table>	Code	Description	Qty	UOM	VM2311A0	SCREWS COVER	1.000	PC				
Code	Description	Qty	UOM														
VM2311A0	SCREWS COVER	1.000	PC														
VM2450A	THROUG-WALL CONNECTION 3 PIPES		KVM2450A	3 PIPES THROUGH-WALL CONNECTION KIT	<table border="1"> <thead> <tr> <th>Code</th> <th>Description</th> <th>Qty</th> <th>UOM</th> </tr> </thead> <tbody> <tr> <td>VM2450A0</td> <td>THROUGH-WAL L CONNECTION 3 PIPES</td> <td>1.000</td> <td>PC</td> </tr> </tbody> </table>	Code	Description	Qty	UOM	VM2450A0	THROUGH-WAL L CONNECTION 3 PIPES	1.000	PC				
Code	Description	Qty	UOM														
VM2450A0	THROUGH-WAL L CONNECTION 3 PIPES	1.000	PC														
VP1121A	LEFT-RIGHT WATER SEALING CAP		VP1121A0	LEFT-RIGHT WATER SEALING CAP													
VP1168A	CHIMNEY SEALING RING		KVP1168A	CHIMNEY SEALING RING KIT	<table border="1"> <thead> <tr> <th>Code</th> <th>Description</th> <th>Qty</th> <th>UOM</th> </tr> </thead> <tbody> <tr> <td>VI1220A1</td> <td>4,2x12 TCB SELF-TAPPIN G SCREW</td> <td>3.000</td> <td>PC</td> </tr> <tr> <td>VP1168A0</td> <td>CHIMNEY SEALING RING</td> <td>1.000</td> <td>PC</td> </tr> </tbody> </table>	Code	Description	Qty	UOM	VI1220A1	4,2x12 TCB SELF-TAPPIN G SCREW	3.000	PC	VP1168A0	CHIMNEY SEALING RING	1.000	PC
Code	Description	Qty	UOM														
VI1220A1	4,2x12 TCB SELF-TAPPIN G SCREW	3.000	PC														
VP1168A0	CHIMNEY SEALING RING	1.000	PC														